

[Content](#)

[A-Z](#)



OWNER'S HANDBOOK.

BMW 5 SERIES SALOON.





WELCOME TO BMW.

Owner's Handbook.

Congratulations on your choice of a BMW.

The better you are acquainted with your vehicle, the easier you will find it is to operate in traffic. We therefore request:

Please read the Owner's Handbook before setting out in your new BMW. Also use the Integrated Owner's Handbook in your vehicle. It contains important information on how to operate your vehicle, helping you get the most out of your BMW's technical features. It also contains information to help keep your BMW operating safely on the road and maintain its full resale value.

When the vehicle leaves the factory, the printed Owner's Handbook is the most up-to-date version. After a vehicle software update – for example, a Remote Software Upgrade – the Integrated Owner's Handbook for the vehicle will contain updated information.

Supplementary information is provided in further on-board literature.

We wish you a safe and pleasant journey.

TABLE OF CONTENTS

After a vehicle software update – for example, a Remote Software Upgrade – the Integrated Owner's Handbook for the vehicle will contain updated information.

! NOTES

Notes	6
-------------	---

🔧 QUICK REFERENCE

Getting in	22
Adjustment and operation	26
On the move	30

👉 CONTROLS

Vehicle cockpit	38
Sensors in the vehicle	42
Vehicle operating condition	47
BMW iDrive	51
BMW Remote Software Upgrade	70
Personal settings	74
Opening and closing	80
Seats, mirrors and steering wheel	106
Carrying children safely	122
Driving	133
Displays	148
Light and vision	170
Safety	184
Driving stability control systems	223
Driver assistance systems	227
Parking	260
Driving comfort	290
Air conditioning	291
Interior equipment	306
Storage compartments	315
Luggage compartment	318

DRIVING HINTS

Driving precautions	324
Trailer and rear carrier	330
Saving fuel	340

MOBILITY

Refuelling	346
Wheels and tyres	348
Engine compartment	371
Operating fluids	374
Maintenance	386
Replacing parts	389
Help in case of a breakdown	394
Care	404

REFERENCE

Technical data	410
Seats for child restraint systems	414
Appendix	416
Everything from A to Z	422

© 2023 Bayerische Motoren Werke

Aktiengesellschaft

Munich, Germany

Not to be reproduced, wholly or in part, without written permission from BMW AG, Munich.
English ID8 VI/23, -

Printed on environmentally friendly paper, bleached without chlorine, suitable for recycling.

Notes

About this Owner's Handbook

Orientation

The quickest way to find information on a particular topic or feature is to consult the alphabetical index.

For an overview of the vehicle, we recommend the quick reference in the Owner's Handbook.

Validity of Owner's Handbook

Vehicle production

When the vehicle leaves the factory, the contents of the printed Owner's Handbook are up to date. Any updates introduced after the copy deadline may result in discrepancies between the printed Owner's Handbook and the Integrated Owner's Handbook in the vehicle.

Notes on updates can be found in the appendix of the printed Owner's Handbook for the vehicle.

After a software update in the vehicle

After a vehicle software update, for example, via Remote Software Upgrade, the Integrated Owner's Handbook for the vehicle will contain the latest information.

Owner's Handbook for Navigation, Entertainment, Communication

The Owner's Handbook for Navigation, Entertainment, Communication is available as a printed book from authorised Service Partners.

These topics are also covered in the Integrated Owner's Handbook in the vehicle.

Media overview

General

Content from the Owner's Handbook can be accessed through various media. The Owner's Handbook is available in the following media:

- ▶ Printed Owner's Handbook.
- ▶ Integrated Owner's Handbook in the vehicle.

Printed Owner's Handbook

The printed Owner's Handbook shows all standard equipment, national-market equipment and optional equipment which is offered or may be offered in future on a model-specific basis.

Integrated Owner's Handbook in the vehicle

Principle

The Integrated Owner's Handbook shows all standard equipment, national-market equipment and optional equipment which is offered or maybe offered in future on a model-specific basis. The Integrated Owner's Handbook can be shown on the control display.

Selecting the Owner's Handbook

1. ■■ Apps menu
2. "All apps"
3. "Owner's Handbook"
4. Select the required method of accessing the contents.

Scrolling within the Owner's Handbook

Swipe up or down until the next or previous contents are displayed.

Context-sensitive help

General

The Integrated Owner's Handbook can be accessed from any menu. Depending on the selected function, the associated description or the main menu of the Integrated Owner's Handbook is displayed.

Selecting context-sensitive help from a menu

1. Press and hold the desired menu item.
2. "General help"

Selecting context-sensitive help from a Check Control message

To switch directly from the Check Control message on the control display:

"Owner's Handbook"

Supplementary Owner's Handbooks

Please also pay attention to the Supplementary Owner's Handbooks which are provided along with the on-board literature as required.

Additional sources of information

Authorised Service Partner

An authorised Service Partner, for example a dealership or a BMW Service Partner will be happy to answer any questions you may have.

Internet

Vehicle information and general information on BMW – on technology, for example – are available on the Internet: www.bmw.com.

BMW Driver's Guide App

The BMW Driver's Guide App shows all standard equipment, national-market equipment and optional equipment which is offered or

may be offered in future on a model-specific basis. The app can be displayed on smartphones and tablets.

BMW Driver's Guide web version

BMW Driver's Guide Web shows all standard, national-market and optional equipment which is offered or may be offered in future on a model-specific basis. BMW Driver's Guide Web can be displayed on any current browser.

Icons and displays

Icons in the Owner's Handbook

Icon	Meaning
	Precautions that must be followed in order to avoid the possibility of injury to yourself and to others as well as serious damage to the vehicle.
	Measures that can be taken to help protect the environment.
"..."	Texts on a display in the vehicle for selecting functions.
>...<	Commands for the voice control system.
>>...<<	Replies by the voice control system.

Actions

Actions that need to be carried out are shown as a numbered list. The list of steps must be carried out in the specified sequence.

1. First action.
2. Second action.

Lists

Alternative options and lists of items with no implied sequence are shown as bullet point lists:

- ▷ First option.
- ▷ Second option.

Icon on components and assemblies

 This symbol on a vehicle component indicates that further information on the component is available in the Owner's Handbook.

Vehicle equipment

This Owner's Handbook shows all standard equipment, national-market equipment and optional equipment which is offered or will be offered on a model-specific basis, i.e. in the model range. As a result, this Owner's Handbook may also contain descriptions and illustrations of equipment, systems and functions which are not installed in the vehicle in question, for example due to:

- ▷ Selected optional equipment.
- ▷ National-market version or national-market equipment.
- ▷ Possibility of subsequent enabling and software updates.

This also applies to safety-relevant functions and systems.

Before starting a journey, check whether a piece of equipment or a function that is described is available in the vehicle. Information about whether a function is currently available in the vehicle or whether and when the function can be installed in the vehicle can be obtained from an authorised Service Partner or another qualified Service Partner.

If a piece of equipment, system or function is described in the Owner's Handbook, this does not mean that it will be available in the vehicle. Please comply with the relevant laws and regulations when using the corresponding functions and systems.

If certain equipment and models are not described in this Owner's Handbook, refer to the Supplementary Owner's Handbooks provided.

In right-hand drive vehicles, some operating elements are arranged differently from those shown in this Owner's Handbook.

Production date

The production date of your vehicle can be found at the bottom of the body pillar on the driver's door.

The production date is defined as the calendar month and the calendar year in which the vehicle body and the transmission assemblies are joined and the vehicle is driven or moved from the production line.

Status of the Owner's Handbook

General

The high standards of safety and quality that characterise the vehicles are ensured through ongoing development. On rare occasions, this may mean that the features described in this handbook will vary from those in your vehicle.

For Australia/New Zealand: general

When reading this Owner's Handbook, please bear the following in mind: to ensure that our vehicles continue to embody the highest quality and safety standards, we pursue a policy of continuous, ongoing development. Because modifications in the design of both vehicles and accessories may be introduced at any time, your own vehicle's equipment may vary from that described in this manual. For the same reason, it is also impossible to guarantee that all descriptions will be completely accurate in all respects.

We must therefore request your understanding of the fact that the manufacturer of your vehicle is unable to recognise legal claims based on discrepancies between the data, illustrations and descriptions in this Owner's Handbook and your own vehicle's equipment. Please note, too, that some of the optional equipment described in this Owner's Handbook is not available on Australian models due to restrictions imposed by Australian Design Rules and other requirements.

Should you require any further information, please contact your Service Partner or a qualified specialist workshop, who will be pleased to advise you.

Validity of Owner's Handbook

Vehicle production

When the vehicle leaves the factory, the contents of the printed Owner's Handbook are up to date. Any updates introduced after the copy deadline may result in discrepancies between the printed Owner's Handbook and the Integrated Owner's Handbook in the vehicle.

Notes on updates can be found in the appendix of the printed Owner's Handbook for the vehicle.

After a software update in the vehicle

After a vehicle software update, for example, via Remote Software Upgrade, the Integrated Owner's Handbook for the vehicle will contain the latest information.

Your own safety

Intended use

Please comply with the following when using the vehicle:

- ▷ Owner's Handbook.
- ▷ Information attached to the vehicle. Do not remove stickers.
- ▷ Technical data of the vehicle.
- ▷ The applicable laws and safety standards of the country in which the vehicle is used.
- ▷ Vehicle papers and legal documents.

Warranty

The vehicle is technically designed for the operating conditions and approval (homologation) requirements of the country to which it was first delivered. If the vehicle is to be driven in another country, it may need to first be adapted to any different operating conditions and approval requirements prevailing in that country. If the vehicle does not comply with the homologation requirements in a certain country, no warranty claims can be lodged there for the vehicle. Warranty claims may also be invalidated if the electrical system has been modified, for example through the use of control units, hardware, or software which the vehicle manufacturer classifies as unsuitable. An authorised Service Partner is able to provide further information.

Note: in addition to the warranty required by law, the selling Authorised BMW Retailers or the selling BMW AG subsidiaries in Germany grant additional benefits with the purchase of new BMW vehicles within the framework of the BMW Warranty Booklet. More information: www.bmw.de/qualitaetsbrief.

Maintenance and repairs

The advanced technology used in your vehicle, for example the state-of-the-art materials and high-performance electronics, requires appropriate maintenance and repair methods.

The vehicle manufacturer therefore recommends having the corresponding work performed by an authorised Service Partner, e.g., a BMW Service branch or Service Partner. If you choose to use a different specialist

workshop, BMW recommends using one that performs the corresponding work, such as maintenance and repair, in accordance with BMW specifications and that employs properly trained personnel. In the Owner's Handbook, facilities of this kind are referred to as "another qualified Service Partner or a specialist workshop".

If work such as maintenance and repair is carried out incorrectly, it could result in subsequent damage with associated safety risks.

Incorrectly performed work on the vehicle paintwork can cause components, for example the radar sensors, to fail or malfunction, resulting in a safety hazard.

Parts and accessories

BMW recommends using parts and accessories that are approved by BMW and are therefore suitable for this purpose.

You are recommended to consult a BMW Service Partner for advice on genuine BMW parts and accessories, other BMW approved products and expert advice on all related matters.

The safety and compatibility of these products in conjunction with BMW vehicles have been checked by BMW.

BMW accepts product responsibility for genuine BMW parts and accessories. However, BMW cannot accept liability for parts or accessory products of any kind which it has not approved.

BMW is unable to assess each third-party product of outside origin as to its suitability for use on BMW vehicles without safety risk. Likewise no guarantee can be assumed even if the product has been granted official approval in a specific country. Tests performed for such approvals cannot always cover all operating conditions for BMW vehicles, and some of them therefore are insufficient.

Vehicle data and data protection

Responsibility and rights

Responsibility for data

Within the scope of data protection directives and legislation, the manufacturer of the vehicle is responsible for processing personal data which is collected when the vehicle is used or from web pages, customer support, online services, and marketing campaigns.

Personal identification

Every vehicle has a unique vehicle identification number. Depending on the country, and with the assistance of the relevant authorities, the registered keeper can be identified from the vehicle identification number and the number plate. There are also other ways of tracing data collected in the vehicle back to the driver or registered keeper, for example via the ConnectedDrive account used.

Data protection laws

In accordance with current data protection law, vehicle users have certain rights vis-à-vis the vehicle manufacturer or companies that collect or process their personal data.

Vehicle users have a free and comprehensive right of access to their personal data which has been collected and held by organisations.

Such organisations could be:

- ▷ Vehicle manufacturer.
- ▷ Qualified Service Partners.
- ▷ Specialist workshops.
- ▷ Service providers.

Vehicle users may request information about what personal data has been saved, what it is used for and where it has come from. Proof of ownership or use is required in order to obtain this information.

The right of access also extends to information about data that has been transferred to other companies or bodies.

Please refer to the vehicle manufacturer's website for the applicable data protection policy. This data protection policy contains information about the right to have data deleted or corrected. The vehicle manufacturer's website also provides its contact details and those of its data protection officer.

The registered keeper can have the data stored in the vehicle read out by an authorised Service Partner, or another qualified Service Partner, or a specialist workshop, for a fee, as necessary.

Vehicle data is read out by the socket for on-board diagnosis, which is required by law.

Data processing

The collection of personal data may be necessary to enable the manufacturer of the vehicle to fulfil obligations to the customer or to legislators, or to offer high-quality products and services.

These include, for example:

- ▶ To fulfill contractual obligations regarding the sale, servicing and repair of vehicles, for example sales processes, maintenance.
- ▶ To fulfill contractual obligations regarding the provision of digital vehicle services, for example BMW ConnectedDrive.
- ▶ To safeguard product quality and the research and development of new products, and to optimise service processes.
- ▶ To perform sales, service and administration processes, including branches and National Sales Companies.
- ▶ To provide customer support, for example contract processing.
- ▶ To conduct advertising communication and market research on the basis of personal consent.

- ▶ To fulfil legal obligations, for example information regarding Technical Campaigns.
- ▶ To process warranty claims.

Data collection

Type of data collected

Depending on the situation, the following personal data may be collected.

Contact details

- ▶ Name, address, telephone number.
- ▶ Email address.

Personal data

- ▶ Personal information provided by customers, for example date of birth, education, household size or occupation.
- ▶ Data to determine identity, for example driver's licence.

Contract data

- ▶ Customer number, contract number, booked online services.
- ▶ Stored payment information, for example credit card number.

Credit rating

- ▶ Information about transactions.
- ▶ Information about fraud or criminal offences.

Interests

Information provided by the customer regarding areas of interest, for example product preferences, hobbies, and other personal preferences.

Use of web pages and communication

- ▶ Information on how web pages are used and whether messages are opened or forwarded.
- ▶ Account information regarding online services, customer portals, and prospective customer portals.

Transaction and interaction data

Information on the purchasing of products and services, interactions with customer support and participation in market research studies.

Use of apps and services of the vehicle manufacturer

Information on the use of apps on mobile devices and online services.

Information on vehicle functions and settings

Information on functions and settings in the vehicle, for example when using online services.

Vehicle-related sensor data and usage data

Data generated or processed in the vehicle.

- ▶ Driver assistance systems: processing of sensor data which is used to evaluate the vehicle's surroundings or the driver's behaviour.
- ▶ Personal settings: settings saved in the vehicle profile, for example seat setting.
- ▶ Multimedia, navigation, for example destinations.

Time of data collection

Personal data may be collected at the following times:

- ▶ When the customer makes direct contact with the manufacturer of the vehicle, for example via the web page.
- ▶ When requesting information on products and services or direct purchases, for example on web pages or in apps.

- ▶ When making direct purchases, for example on the web page.
- ▶ When purchasing services directly, for example online services.
- ▶ When the customer responds to direct marketing activities, for example when personal data is provided.
- ▶ When using vehicles, products, services and digital offers, for example web pages, apps.
- ▶ When communicating personal data through qualified partners of the vehicle manufacturer or through third-party providers, provided that data protection requirements are met.
- ▶ When providing personal data through certified address providers, provided that data protection requirements are met.
- ▶ When vehicle data, including the vehicle identification number, is read out during service, maintenance and repair activities.

Data in the vehicle

General

A number of electronic control devices are installed in your vehicle. Electronic control units process data that they receive from vehicle sensors, generate themselves, or exchange with one another, for example. Many of the control units are necessary for safe operation of the vehicle, or provide assistance while driving, for example driver assistance systems. There are also control devices which manage comfort or infotainment functions.

Data saved in the vehicle can be deleted at any time. This data is only transmitted to third parties if expressly requested in the course of using online services. The transfer depends on the settings selected for using the services.

Sensor data

Driver assistance systems, for example Active Cruise Control, Collision Warning, or Attentive-

ness Assistant, process sensor data which is used to evaluate the vehicle's surroundings or the driver's behaviour.

These include, for example:

- ▶ Status messages relating to the vehicle and its individual components, for example wheel speed, wheel circumferential velocity, deceleration, lateral acceleration, fastened seat belts.
- ▶ Ambient conditions, for example temperature, rain sensor signals.

The data is processed within the vehicle and is usually transient. It is only saved for longer than the operating time if it is required in order to provide services agreed with the customer.

Electronic components

Electronic components, for example control devices and vehicle keys, contain components for storing technical information. Information about the vehicle condition, component use and wear, maintenance requirements, events or faults can be stored temporarily or permanently.

This information generally documents the condition of a component, a module, a system or the vehicle's surroundings, for example:

- ▶ Operating states of system components, for example fill levels, tyre inflation pressure, battery status.
- ▶ Malfunctions and faults of important system components, for example lights and brakes.
- ▶ Responses of the vehicle to particular driving situations, for example triggering of an airbag, activation of the driving stability control systems.
- ▶ Information on vehicle-damaging events.

The data is required so that the control units can perform their functions. It is also used for detecting and rectifying malfunctions, as well as to optimise vehicle functions.

Most of this data is transient and is only processed within the vehicle itself. Only a small proportion of the data is stored in event or fault memories in response to specific circumstances.

Personal settings

Convenience functions, such as seat, climate or light settings, enhance the driving experience. The personal settings for these functions can be saved in a BMW ID or in a driver profile within the vehicle and retrieved as required, for example if the settings have been changed in the meantime by another driver. Depending on the equipment, these profiles can be saved in the vehicle manufacturer's secure data systems. When changing vehicles, a BMW ID can simply be transferred to another vehicle.

The vehicle settings stored in a BMW ID or in a driver profile can be changed at any time. A BMW ID or a driver profile can be deleted at any time.

Multimedia and navigation

Data can be additionally imported into the vehicle entertainment and communication system, for example, via smartphone. The imported data can be processed within the vehicle, for example to play the user's favourite music.

Depending on the equipment, this data includes:

- ▶ Multimedia data, such as music or photos, for playback in an integrated multimedia system.
- ▶ Address book data for use in conjunction with an integrated hands-free system or an integrated navigation system.
- ▶ Destinations: depending on the equipment, route guidance can be started automatically using destinations learned by the navigation system.
- ▶ Data on usage of Internet services.

This data may be saved locally in the vehicle or stored on a device that has been connected to

the vehicle, for example, a smartphone or USB stick.

Service data

General

When services are required, for example repairs, service operations, warranty work and quality assurance measures, this technical information can be read out from the vehicle together with the vehicle identification number.

Stored data

Electronic vehicle components may contain data storage media which store technical information relating to the vehicle condition, events and faults. The data required for service measures is processed locally and is deleted automatically once the work is complete. An authorised Service Partner or another qualified Service Partner or a specialist workshop can read out the information. During servicing and repair work, data is read out by the socket for on-board diagnosis using special diagnosis systems and sent to the vehicle manufacturer. The customer is entitled to withhold consent to the data being read out and forwarded.

Optimising service processes

The vehicle manufacturer maintains documentation relating to each vehicle to ensure the best possible service is provided. Within the scope of legal requirements, this documentation may be made available to authorised third parties, for example specialist workshops.

The authorised third parties may only use this data for the purposes of performing the service or repair order in question. This prevents work from being duplicated unnecessarily on the vehicle, for example.

Ensuring product quality

The data logs the technical conditions of the vehicle and helps in locating faults, complying

with warranty obligations and improving quality.

To ensure product quality and the development of new products, data on the usage of individual components and systems, for example, lights, brake, electric windows, displays, can be read out. This data helps the vehicle manufacturer to optimise the design of components and systems. Data analysis also provides the basis for Technical Campaigns and mandatory recalls.

Furthermore, the manufacturer has product monitoring obligations to meet in line with product liability law. To fulfil these obligations, the vehicle manufacturer requires technical data from the vehicle. This also includes the software versions in the vehicle.

Goodwill and warranty claims

Data from the vehicle can also be used to check customer warranty claims. If goodwill or warranty claims are asserted, the data is read out and transferred to the vehicle manufacturer to resolve the claims promptly.

Fault and event memories in the vehicle can be reset when an authorised Service Partner or another qualified Service Partner or a specialist workshop performs repair or servicing work.

Control over data

You may request the stopping of data transfers to the vehicle manufacturer for the purpose of ensuring product quality and optimising service processes.

Legal requirements regarding data disclosure

According to current law, the vehicle manufacturer is obliged to provide the authorities with any data it has stored. Data is provided to the extent required and on a case-by-case basis, for example to investigate a criminal offence.

Current law also gives state bodies authorisation to read out data from the vehicle them-

selves for individual cases. Information can be read out from the airbag control unit, etc. to shed light on the circumstances of an accident, for example.

Within the framework of legal obligations in the EU, certain vehicle consumption data, such as fuel or energy consumption and distance travelled, also called OBFCEM data, is sent to the EU Commission by the vehicle manufacturer. The registered keeper may refuse to provide this data for this purpose.

Mobile devices

Depending on the equipment, mobile devices such as smartphones can be connected to the vehicle to control smartphone functions from the vehicle, for example Apple CarPlay. Sound and images from the mobile device may be played back or displayed through the multimedia system in the vehicle, for example.

Selected information is transferred to the mobile device at the same time. Depending on the type of integration, this includes position data and other general vehicle information, for example. This enables optimum use of selected apps, for example navigation and music playback. How the data is processed further is determined by the provider of the particular app being used.

Services

General

If the vehicle has a wireless network connection, data can be exchanged between the vehicle and other systems, for example with BMW ConnectedDrive.

Services from the vehicle manufacturer

The various functions of online services provided by the vehicle manufacturer are described at appropriate points, for example in the Owner's Handbook or on the manufacturer's web

page. The relevant legal information pertaining to data protection is also given.

Personal data may be used to provide online services. Data is exchanged over a secure connection, for example with the vehicle manufacturer's data systems set up for this purpose.

Any collection, processing and use of personal data above and beyond that needed to provide the services always requires legal permission, a contractual agreement or consent of the user.

BMW ConnectedDrive

BMW ConnectedDrive networks the vehicle with a number of digital services. When these services are used, only the data stored in the vehicle and required to provide the service is transferred online, for example information on identifying and locating the vehicle. Usage is based on a contractual agreement with the user.

In individual cases, the transfer of data is triggered as a result of predefined events, such as an intelligent emergency call. The wireless network connection is established via an in-vehicle transmitter and receiver unit or via personal mobile devices brought into the vehicle, for example smartphones. Data transfer can be deactivated on request.

The wireless network connection enables online functions to be used. These include online services and apps supplied by the vehicle manufacturer or by other providers.

Services from other providers

When using online services from other providers, these services are the responsibility of the relevant provider and subject to their data protection conditions and terms of use. The vehicle manufacturer has no influence over the data that is exchanged.

Information as to how personal data is collected and used in relation to services from third parties, the scope of such data and its pur-

pose, can be obtained from the relevant provider.

Personal decision

Every user decides for themselves whether they wish to enter into a contract for a service such as BMW ConnectedDrive. Information on the extent of data processing and the content involved is provided in writing before the service is acquired and forms part of the vehicle handover.

The user has the option to deactivate the services at any time and consequently to stop the data processing required for the services. It is also possible to have the entire data connection activated or deactivated. Excluded from this are functions and services which are required by law, for example emergency call systems.

Transparency concerning vehicle data

BMW CarData provides transparency in handling vehicle data with the use of BMW ConnectedDrive. BMW CarData enables users to control whether vehicle data being processed in the context of BMW ConnectedDrive is transferred to third parties. Users can decide for each individual service offering whether data access is to be granted or refused to third parties, for example to insurance companies.

An archive can also be requested from BMW CarData at any time. The archive provides information on the data that has been transmitted and saved in the context of BMW ConnectedDrive. BMW CarData can only be accessed by third-party providers via the vehicle manufacturer's servers. Direct access to the vehicle and its data is not permitted.

More information on BMW CarData is available on the BMW ConnectedDrive Customer Portal.

Statutory emergency call system

Principle

The eCall emergency call system required by law enables manual or automatic emergency calls to be made, for example in the event of an accident.

The emergency calls are answered by the public rescue coordination centre.

General

For information on the eCall statutory on-board emergency call system based on the 112 emergency call, as well as its operation and its functions, see the chapter on emergency calls.

The eCall service based on the 112 emergency call is a public service of general interest and is provided free of charge.

If a serious accident occurs, the legal emergency call system is activated automatically by on-board sensors as standard practice. It is also triggered automatically if the vehicle is equipped with an intelligent emergency call system that fails to work in the event of a serious accident.

The legal emergency call system can also be triggered manually if required.

If a critical system failure occurs that would put the eCall statutory emergency call system out of operation, the vehicle occupants receive a warning.

For further information:

- ▶ Emergency call, see page [396](#).
- ▶ Malfunction, see page [397](#).

Information on data processing

The eCall statutory emergency call system processes personal data in accordance with the following regulations:

- ▷ Protection of personal data: Regulation (EU) 2016/679 of the European Parliament and of the Council.
- ▷ Protection of personal data: Directive 2002/58/EC of the European Parliament and of the Council.

Personal data is only processed for the purpose of transmitting eCall emergency calls to the single European emergency call number 112.

SIM card

The legal emergency call system operates via mobile radio through the SIM card installed in the vehicle. The SIM card is not permanently connected to the mobile phone network; rather, it remains connected only as long as the emergency call is active.

Data types and their recipients

The legal emergency call system may only collect and process the following data:

- ▷ The vehicle identification number for rapidly identifying the vehicle, for example the model.
- ▷ Vehicle type, for example passenger car.
- ▷ Type of vehicle drive, for estimating risks during recovery, e.g. fire hazard.
- ▷ The vehicle's position at the time of the accident, its last three locations and the direction of travel in order to locate the vehicle more quickly on very complex route sections, for example.
- ▷ A log of the automatic system activation, along with the time stamp.
- ▷ Control information, which tells rescue services whether the emergency call was triggered automatically or manually, for example.

- ▷ A time stamp for determining the time of the accident in order to optimise the deployment plans of the rescue services.
- ▷ The direction of travel for establishing which side of the carriageway is affected, for example.

The authorities of the state in whose territory the eCall system emergency call is made determine which emergency call centres receive and process the statutory emergency call.

Data processing configuration

The legal emergency call system ensures that the data stored on the system memory can only be accessed outside the system once an emergency call is triggered.

The data collected for the legal emergency call system is only saved in the vehicle and sent to the rescue coordination centre when an emergency call is triggered.

The legal emergency call system ensures that it cannot be traced and that it is not tracked continuously during normal operation.

The legal emergency call system ensures that the data in the internal system memory is deleted automatically and continuously.

The vehicle's location data is continuously overwritten in the system's internal memory so that only the vehicle's last three locations - which the system needs for normal operation - are ever stored.

The activity data log of the eCall statutory emergency call system is retained only for as long as is necessary to handle the eCall emergency call and under no circumstances for any longer than 13 hours after the eCall emergency call was triggered.

Rights of individuals affected by data processing

The individual affected by data processing, for example the registered keeper, has the right to access the data and can request that their personal data, as well as data whose process-

ing does not comply with legal requirements, be corrected, deleted, or restricted as applicable. Each time that data is corrected, deleted or blocked in line with these regulations, the third parties to whom the data was transmitted must be notified, insofar as this is reasonably practical.

The individual affected by data processing has the right to file a complaint with the relevant data protection body if they believe that their rights have been violated as a result of having their personal data processed.

For matters relating to access rights, please contact an authorised Service Partner or another qualified Service Partner or a specialist workshop.

Intelligent emergency call system

Principle

The intelligent emergency call system enables manual or automatic emergency calls to be placed, for example in the event of an accident.

The emergency calls are answered by an emergency call centre appointed by the vehicle manufacturer.

In addition to the intelligent emergency call system, the legal emergency call system is present in the vehicle and is active depending on the situation.

The registered keeper has the right to use either the intelligent emergency call system or the legal emergency call system.

To request deactivation, please contact an authorised Service Partner or another qualified Service Partner or a specialist workshop.

For further information:

Emergency call, see page 396.

Legal basis

The intelligent emergency call system processes personal data in accordance with the following regulations:

- ▷ Protection of personal data: Regulation (EU) 2016/679 of the European Parliament and of the Council.
- ▷ Protection of personal data: Directive 2002/58/EC of the European Parliament and of the Council.

The ConnectedDrive contract concluded for this feature, as well as the relevant laws, ordinances, and directives of the European Parliament and the European Council, provide the legal basis for the activation and function of the Intelligent Emergency Call system.

The relevant ordinances and directives govern the protection of individuals in terms of processing personal data.

The intelligent emergency call system processes personal data in accordance with European directives on the protection of personal data.

The Intelligent Emergency Call system processes personal data only with the registered keeper's consent.

The Intelligent Emergency Call system and other services providing additional benefit may only process personal data with the express consent of the individual affected by data processing, for example the registered keeper.

SIM card

The intelligent emergency call system operates via mobile radio through the SIM card installed in the vehicle. The SIM card is permanently logged into the mobile phone network so a connection setup can be established quickly. The data is sent to the vehicle manufacturer in emergencies.

Improving quality

The vehicle manufacturer also uses the data sent as part of an emergency call to improve product and service quality.

Position determination

Only the provider of the mobile phone network is able to determine the position of the vehicle based on mobile phone mast locations. The network operator is not able to link the vehicle identification number to the phone number of the installed SIM card. Only the vehicle manufacturer is able to link the vehicle identification number to the phone number of the installed SIM card.

Log data for emergency calls

The log data for emergency calls is saved in a vehicle memory. The oldest log data is regularly deleted. The log data includes information on when and where an emergency call was placed, for example in the event of an accident. In exceptional cases, the log data can be read out from the vehicle memory. The log data is usually read out only if a court order has been issued and is only possible when the relevant devices are connected directly to the vehicle.

Automatic emergency call

The system is designed so that it automatically triggers an emergency call if the vehicle sensors detect an accident of corresponding severity.

Sent information

If an emergency call is made by the intelligent emergency call system, the same information is sent to the appointed emergency call centre as is normally sent to the public rescue coordination centre by the legal emergency call system.

Furthermore, the intelligent emergency call system also conveys the following additional information to an emergency call centre appointed by the vehicle manufacturer and, where applicable, to the public rescue coordination centre:

- ▶ Accident data, for example the direction of the collision as detected by the vehicle sen-

sors in order to assist the rescue services in their deployment plans.

- ▶ Contact data, for example the phone number of the installed SIM card and the driver's phone number, if available, so that those involved in the accident can be contacted quickly if necessary.

Data storage

The data relating to a placed emergency call is saved in the vehicle. The data contains information about the emergency call, for example the place and time it was made.

The emergency call centre saves audio recordings of the emergency call.

Audio recordings of the customer are saved for 24 hours, in case details of the emergency call need to be analysed. After that, the audio recordings are deleted. Audio recordings of the emergency call centre employee are saved for 24 hours for quality assurance purposes.

Disclosure of personal data

The data obtained in the context of an intelligent emergency call is only used to process the emergency call. If legally obliged to do so, the vehicle manufacturer will disclose the data it has processed and, where applicable, still has saved.

Statutory emergency call system

The holder of a vehicle equipped with an intelligent emergency call system and the legally required emergency call system is entitled to use the legally required emergency call system instead of the intelligent emergency call feature.

To request deactivation, please contact an authorised Service Partner or another qualified Service Partner or a specialist workshop.

The legal emergency call system is always on standby in addition to the intelligent emergency call system. The legal emergency call system takes over the emergency call function

if the intelligent emergency call system is not operational for technical reasons, for example if the emergency call centre appointed by the vehicle manufacturer cannot be reached.

The eCall statutory emergency call system uses the infrastructure of the 112 public emergency call number.

The system can be configured so that emergency calls are always made by the legal emergency call system and not by the intelligent emergency call system. Have the settings carried out by an authorised Service Partner or another qualified Service Partner or a specialist workshop.

Event data recorder EDR

This vehicle is equipped with an event data recorder EDR. The main function of this EDR is to record data in the event of crash or near-miss situations, such as triggering of an air-bag or collision with a road obstacle; this data helps to understand how the vehicle's systems behaved. EDR serves to record data for a short period, typically maximum 30 seconds or typically less, relating to driving dynamics and the vehicle's safety systems.

The EDR installed in this vehicle is used for recording the following data, for example:

- ▶ The operating behaviour of various vehicle systems.
- ▶ Whether the driver and front passenger had fastened their seat belts.
- ▶ How far the driver had pressed the accelerator pedal and/or brake pedal, if at all.
- ▶ What speed the vehicle was travelling at.

This data can help to gain a better understanding of the circumstances leading to crashes and injuries.

EDR data is only recorded by the vehicle if there is a severe accident; under normal driving conditions, no data is recorded by the EDR and no personal data is saved either, for ex-

ample no data about name, gender, age or accident location.

However, other parties such as law enforcement authorities can link the EDR data with the sort of personally identifiable data that is routinely gathered during the investigation of an accident.

To read out the data recorded by the EDR, it is necessary to have special equipment and access to the vehicle or the EDR. In addition to the vehicle manufacturer, other parties such as law enforcement authorities in possession of special equipment can read out the information if they have access to the vehicle or the EDR.

Vehicle identification number

General

Depending on the national-market equipment, the vehicle identification number is located at different positions in the vehicle. This chapter describes all the positions that are possible for the model range.

Engine compartment

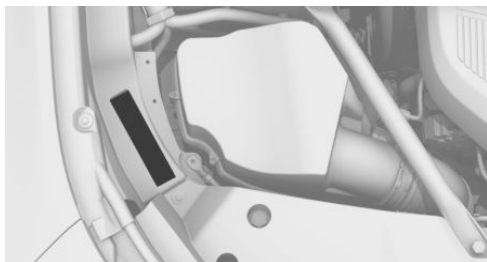

The vehicle identification number is engraved in the engine compartment, on the right side of vehicle.

Type plate on right-hand side



The vehicle identification number is on the type plate on the right-hand side of vehicle.

Type plate on left-hand side



The vehicle identification number is on the type plate on the left-hand side of vehicle.

Windscreen



The vehicle identification number is additionally located behind the windscreen.

iDrive

It is also possible to display the vehicle identification number via iDrive.

1.  Apps menu
2. "All apps"
3. "Mobile devices"
4. "Settings"
5. "Vehicle ID (VIN):"

Getting in

Opening and closing

Vehicle key



Buttons on the vehicle key.

Icon	Meaning
	Unlock.
	Lock.
	Depending on the equipment: Open/close the luggage compartment. Open the luggage compartment.
	Home lights.

Access to vehicle interior

Unlocking with the vehicle key

 Press the button on the vehicle key.

If only the driver's door and the fuel filler flap have been unlocked because of the settings, press the button on the vehicle key again to unlock the other vehicle access points.

Locking with the vehicle key



1. Close the driver's door.
2.  Press the button on the vehicle key. All vehicle access points are locked.

Central locking buttons

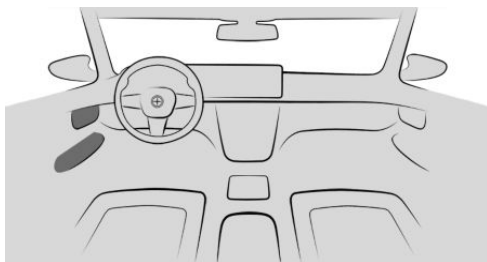
Overview



The central locking system buttons are located on the front door.

-  Lock.
-  Unlock.

Locking the vehicle

 Press the button with the front doors closed.

The fuel filler flap remains unlocked.

Unlocking the vehicle

 Press the key.

Access to the luggage compartment

Opening the luggage compartment

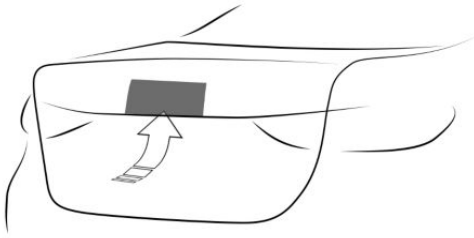



- ▶ Unlock the vehicle and then press the button on the luggage compartment.
- ▶  Press and hold the button on the vehicle key for approximately 1 second.

The doors are unlocked if applicable.

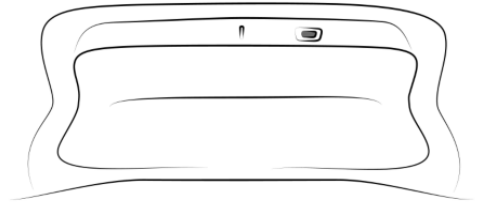
Closing the luggage compartment automatically



Depending on the equipment:

- ▶  Press the button on the luggage compartment.
- ▶  Hold down the button on the vehicle key until the luggage compartment is closed.

Closing the luggage compartment manually

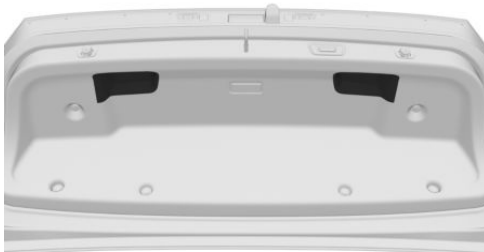

Depending on equipment: pull down the luggage compartment lid by the recessed handles.

Displays, operating elements

Around the steering wheel

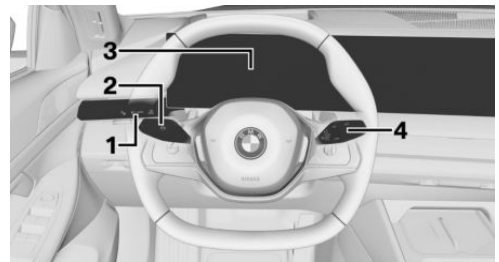

- 1 Light switch
- 2 Turn indicator, high-beam headlight
- 3 Instrument cluster
- 4 Windscreen wipers

Indicator and warning lights

Indicator and warning lights can illuminate in a variety of combinations and colours.

When switching on drive-ready state, the functionality of some lights is checked and they illuminate briefly.

Driver's door

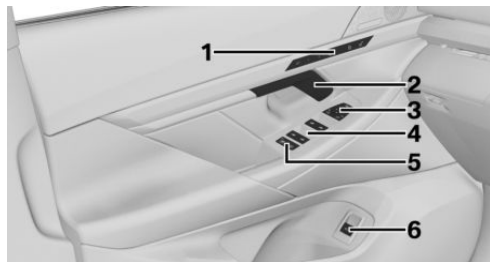

- 1 Central locking system
Seats, comfort functions
- 2 Opening the door
- 3 Exterior mirrors
- 4 Window lifters
- 5 Safety switch
- 6 Luggage compartment

Control centre

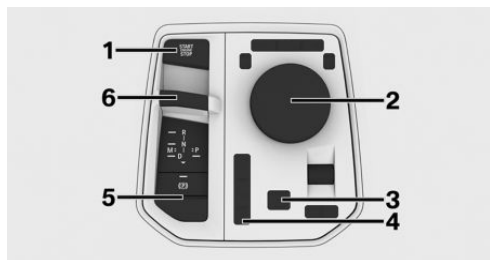





- 1 Start/Stop knob
- 2 Controller
- 3 My Modes
- 4 Assistance systems
- 5 Parking brake, Automatic Hold
- 6 Selector lever

BMW iDrive

Principle

BMW iDrive is the vehicle's display and operating concept and includes a wide range of functions.

Buttons on the Controller

Button	Function
	To go to the main menu.
	Go to Media menu.
	To go to the Telephone menu.
	Go to Navigation menu.
	Go to previous menu.

BMW Intelligent Personal Assistant

Principle

The BMW Intelligent Personal Assistant is a personal assistant that enables natural voice control of various vehicle functions.

Activating voice input

1.  Press the button on the steering wheel briefly.
2. Say the command.

Cancelling voice input

- ▶  Press the button on the steering wheel again.
- ▶ ›Cancel
- ▶ Slide the Controller to the right or left.
- ▶ Press the Controller.

Adjustment and operation

Seats, mirrors and steering wheel

Partly electrically adjustable seats



- 1 Longitudinal direction
- 2 Thigh support
- 3 Backrest angle
- 4 Height, seat angle
- 5 Lumbar support

Electrically adjustable seats

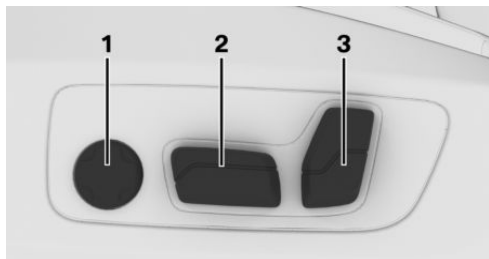

- 1 Lumbar support
- 2 Height/longitudinal direction/seat angle
- 3 Backrest angle/head restraint

Adjusting the head restraint

Adjusting the height: manual head restraints



- ▷ Down: press the button and slide the head restraint downwards.
 - ▷ Up: push the head restraint upwards.
- After adjusting the height, make sure that the head restraint engages correctly.

Adjusting the height: electrical head restraints

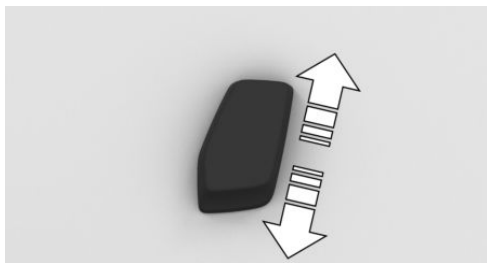

Press the switch up or down.

Adjusting the distance







Press the button and push the head restraint forwards or backwards.

After adjusting the distance, make sure that the head restraint engages correctly.

Adjusting the exterior mirrors



Icon	Meaning
	Fold the exterior mirrors in and out.
	Adjust the exterior mirrors.
	Select left exterior mirror.
	Select right exterior mirror.

Adjusting the steering wheel position

Electrical steering wheel adjustment

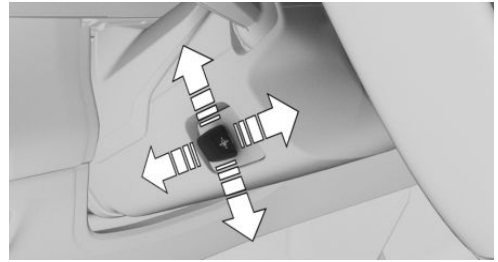

Press the switch to adjust the steering wheel to the correct forward/back position and height for your seat position.

Manual steering wheel adjustment

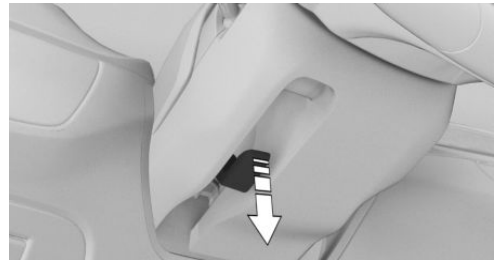

1. Fold the lever down fully.
2. Grip the steering wheel with both hands and adjust it in the longitudinal direction and height of the seat position.
3. Fold the lever back up.

Memory function

Principle

The memory function enables the following settings to be stored and retrieved when required:

- ▷ Seat position.
- ▷ Exterior mirror adjustment.
- ▷ Depending on the equipment: steering wheel position.
- ▷ Height of the Head-up display.

Overview



The memory buttons are on the front doors.

Storing settings

1. Set the desired position.
2.  Press the button. The LED is illuminated.
3. Press the desired Memory button 1 or 2 while the LED is illuminated. A signal sounds.

Go to Settings

Press the desired Memory button 1 or 2.

Infotainment





Navigation destination entry

1.  Navigation menu
2. "Destination input"
A search field and entries such as the search history are displayed.
3. Select the desired entry or search field.
4. If the search field has been selected, enter characters or select one of the displayed POI categories.
If necessary, select **OK** to display further information, such as a preview map.
If necessary, accept the suggested search term.

5. Select the desired entry.
6. "Start route guidance"

Entertainment

depending on the vehicle type, the following buttons are installed either in the centre console or instrument panel:

Button	Function
	Turning the knurled wheel: adjusts the volume. Pressing the knurled wheel: turn sound output on/off.
	Changing the entertainment source.
	Press once: to change the station/music track. Press and hold: to fast forward/rewind the music track.
	

Using the mobile phone

General

Once the mobile phone has been connected in the vehicle, it can be operated using iDrive and the buttons on the steering wheel.

Activate Bluetooth® on the mobile phone.

Connecting via Bluetooth®

1.  Apps menu
2. "All apps"
3. "Mobile devices"
4. "Connect new device"
Mobile phones in range are displayed on the control display.
5. Select the required mobile phone.
6. Compare the control number displayed on the control display with the control number

in the display of the mobile phone and confirm that they match.

7. If necessary, select the connection mode:
"Use Bluetooth"

The device is connected and displayed in the device list.

Accepting a call



Depending on the equipment, incoming calls can be accepted in different ways.

- ▷ Via iDrive:
 "Accept"



- ▷ Press the button on the steering wheel.
- ▷ Use the knurled wheel on the steering wheel to select from the list in the instrument cluster: "Accept"

Dialling a number

1.  Communication menu
2. "More"
3. "Dial number"
4. Enter the numbers.
5.  Select the icon. The call is made using the mobile phone to which the telephone function is assigned.

On the move

Driving

Drive-ready state

Switching on drive-ready state



1. Press the brake.
2. Press the Start/Stop button.

Switching off drive-ready state

1. With the vehicle at a standstill, apply the parking brake.
The engine is switched off.
The vehicle changes to standby state.
The READY display is no longer illuminated and an acoustic signal is heard.
2. Press the Start/Stop button.

Automatic Start/Stop function

The Automatic Start/Stop function helps you to save fuel. It does this by switching off the engine when the vehicle stops, for example in congestion or at traffic lights. Drive-ready state remains switched on. For driving off, the engine starts automatically under the following conditions:

- ▷ By releasing the brake pedal.
- ▷ With Automatic Hold activated: press the accelerator pedal.

Steptronic transmission

Engaging selector lever positions D, N, R, S



- ▷ D Drive position.
- ▷ N Neutral.
- ▷ R Reverse gear.
- ▷ S Sport programme.

Keep the brake applied until ready to drive off, otherwise the vehicle will move when drive position or reverse gear is selected.

Only engage selector lever position R when the vehicle is stationary.

Sport programme: the shift characteristics are designed for sportier drivability.

Engaging selector lever position P



Press the key.

The transmission lock is engaged and the parking brake is engaged.

Parking brake

Applying the parking brake



Press the key.

The LED on the button and the indicator light in the instrument cluster are illuminated.

The parking brake is applied and transmission lock is engaged.

Release the parking brake



Press button with selector lever position P and activated drive-ready state.

Press the button with the brake pedal depressed and drive-ready state switched on. The LED and the indicator light go out.

The parking brake is released.

Parking

Make sure the parking brake is engaged.

Light and vision

Turn indicator, high-beam headlight, headlight flasher

Turn indicators

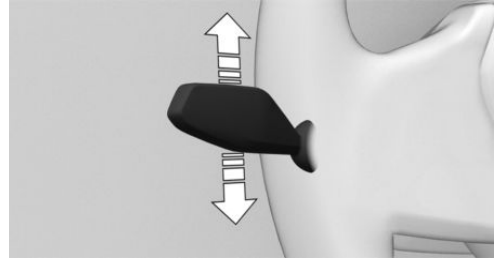

- ▶ Flashing: press the lever past the resistance point.
- ▶ One-touch signalling: lightly tap the lever up or down.
- ▶ To indicate a turn briefly: press the lever as far as the resistance point and hold it there for as long as you wish to indicate a turn.

High-beam headlight, headlight flasher





Press the lever forwards or pull it back.







- ▶ High-beam headlight on, arrow 1.
The high-beam headlight is illuminated when the low-beam headlight is switched on.
- ▶ High-beam headlight off/headlight flasher, arrow 2.

Lights and lighting

Buttons in the vehicle

Icon	Function
	Exterior lights menu.
	Automatic driving lights control. Low-beam headlight. Exterior lights off.
	Rear fog light.

Functions via iDrive

Icon	Function
	Automatic driving lights control.
	Low-beam headlight.
	Side lights.
	Exterior lights off.
	Parking light, left.
	Parking light, right.

Wiper system

Switching on the wiper system

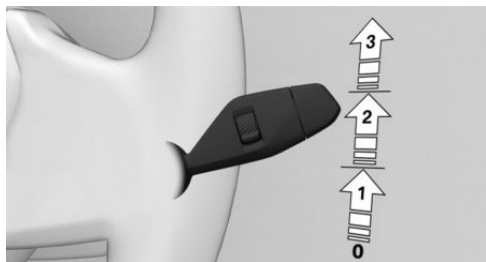

Press the lever upwards to the desired position.

- ▷ Rest position of the windscreen wipers, position 0.
- ▷ Rain sensor, position 1.
- ▷ Normal wiper speed, position 2.
- ▷ Fast wiper speed, position 3.

Switching off the wiper system and flick wiping

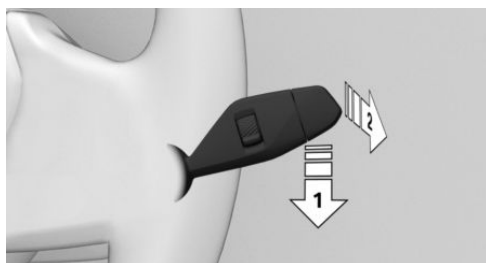

Press the lever downwards or forwards.

- ▷ To switch off: press lever downwards, arrow 1, until position 0 is reached.
- ▷ To flick wipe: press the lever downwards from position 0, arrow 1, and press the lever forwards from position 0 or position 1, arrow 2.

The lever returns to position 0 when released.

Activating/deactivating the rain sensor

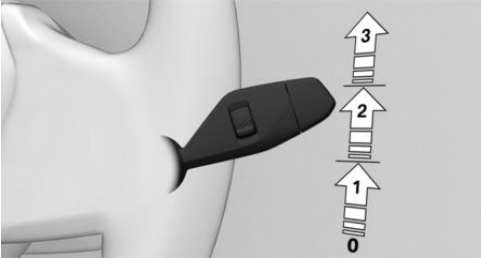

To activate: press the lever upwards once from position 0, arrow 1.

To deactivate: press the lever back to position 0.

Adjusting the sensitivity of the rain sensor

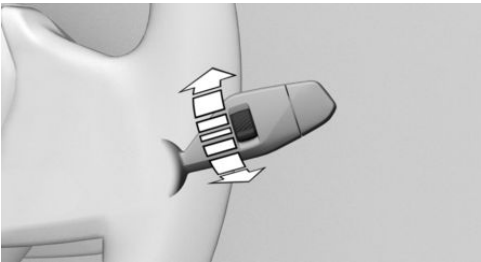

Turn the knurled wheel on the wiper lever.

Cleaning the windscreen

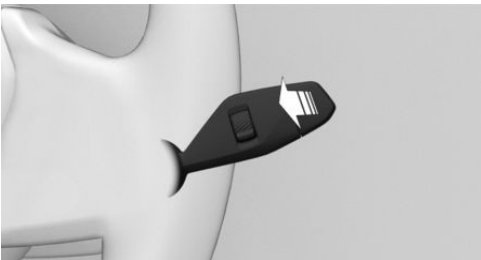















Pull the lever.



Air conditioning

Air conditioning functions

Functions in the air conditioning menu



Icon	Function
	Switching the air conditioning system on/off
	Automatic programme.
	Temperature.
	Air conditioning function.
	Maximum cooling.
	Air recirculation function.
	Automatic air recirculation control.
	Fresh air.
	Amount of air.
	Air distribution.
	SYNC programme.
	Seat heating.

Icon	Function
	Active seat ventilation.
	Steering wheel heating.

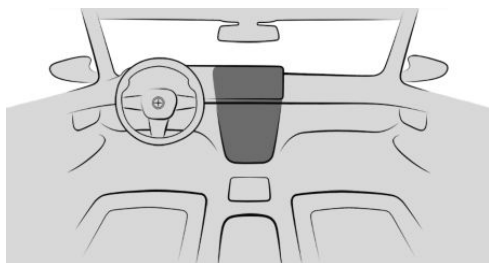

Icon	Function
	Air distribution.
	Seat heating.

Buttons, integrated automatic heating/air conditioning system



Icon	Function
	Defrost function.
	Rear window heating.

Automatic rear air conditioning system

Icon	Function
	Automatic programme.
	Temperature.
	Amount of air.

Pit stop

Refuelling

Fuel filler cap

1. To open the fuel filler flap, press on the rear edge, arrow. The fuel filler flap opens.



2. Turn the fuel filler cap anticlockwise.

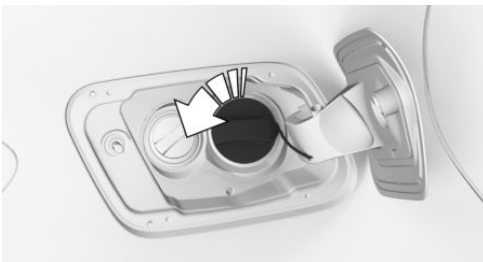

3. Place the fuel filler cap in the holder on the fuel filler flap.

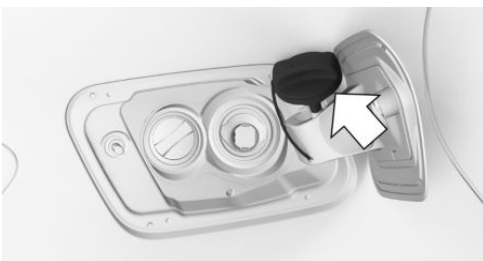

Wheels and tyres

Tyre inflation pressure information



The tyre inflation pressure information can be found on the tyre pressure label on the body pillar of the driver's door.

After adjusting the tyre inflation pressure

If equipped with a Tyre Pressure Monitor, tyre inflation pressure corrections are applied automatically. Make sure that the tyre settings are correct. For tyres that are not listed in the tyre inflation pressure information on the control display, reset the Tyre Pressure Monitor.

If equipped with a Flat Tyre Monitor, reinitialize the Flat Tyre Monitor.

Checking the tyre inflation pressure

Check regularly and adjust as necessary:

- ▶ At least twice a month.
- ▶ Before a long journey.

Electronic oil measurement

Operating requirements

A current reading is available after approximately 30 minutes of normal driving with the internal combustion engine running.

Displaying the engine oil level

1.  Apps menu
2. "Vehicle"

3. "Vehicle status"
4. "Engine oil level"

The engine oil level is displayed.

Topping up engine oil

General

Stop the vehicle safely and switch off drive-ready state before topping up with engine oil.

Topping up engine oil

1. Open the bonnet.
2. Turn the cap anticlockwise to open.



3. Add engine oil.
4. Tighten cap.

How to get assistance

Hazard warning lights

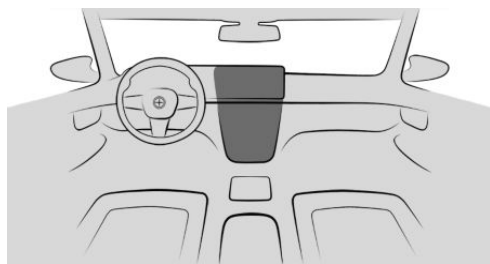

Hazard warning lights button

ConnectedDrive

BMW Assistance

Contact BMW Assistance for information and support on all aspects of your vehicle.

1.  Apps menu
2. "All apps"
3. "BMW Assistance"
4. Select the desired service.

Follow the displays on the control display. A voice contact is established.

BMW Teleservices

Teleservices are services that help to keep the vehicle mobile.

Teleservices may include the following services:

- ▶ BMW Roadside Assistance.
- ▶ BMW Accident Assistance.
- ▶ Teleservice Call.
- ▶ Your Service Partner.



Vehicle cockpit

Vehicle equipment

This chapter describes equipment, systems and functions which are offered or may be offered in future on a model-specific basis, even







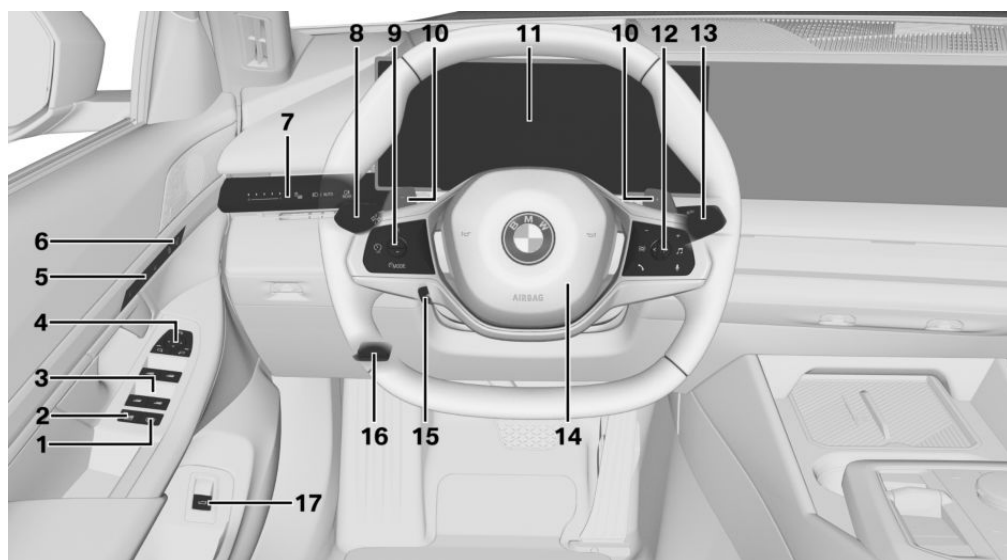

if they are not included in the vehicle in question.

















For further information:

Vehicle equipment, see page 8.

Around the steering wheel



- | | |
|---|--|
| <p>1  Roller sunblind</p> <p>2  Safety switch 104</p> <p>3  Window lifters 102</p> <p>4 Exterior mirror operation 117</p> <p>5 Seat comfort functions</p> | <p> Memory function 119</p> <p> Seat settings menu 54</p> <p>6  Central locking system buttons 97</p> <p> Unlock</p> <p> Lock</p> <p>7 Lights</p> |
|---|--|

-  Exterior lights menu [54](#)
 High-beam Assistant [171](#)
-  Automatic driving lights [173](#)
 Low-beam headlight [173](#)
 Adaptive lighting functions [176](#)
-  Rear fog light [177](#)
- 8** Turn indicator lever
-  Turn indicator [170](#)
-  High-beam headlight, headlight flasher [170](#)
- 9** Buttons on steering wheel, left
-  Switch Cruise Control Systems on/off [231](#)
-  Select Cruise Control System [231](#)
-  To store a speed [231](#)
 Speed Limit Info: activate/deactivate warning [227](#)
-  To set the speed [231](#)
- 10** Shift paddles [138](#)
 Sport Boost function [140](#)
- 11** Instrument cluster [148](#)
- 12** Buttons on steering wheel, right
-  Settings, instrument cluster [148](#)
 Settings for Head-up display [150](#)
-  Volume, see Owner's Handbook for Navigation, Entertainment, Communication [6](#)
-  Audio, see Owner's Handbook for Navigation, Entertainment, Communication [6](#)
-  Voice control, BMW Intelligent Personal Assistant [60](#)
-  Telephone, see Owner's Handbook for Navigation, Entertainment, Communication [6](#)
-  For selecting configuration menus for the instrument cluster and Head-up display [148](#)
 Operation of selection lists [159](#)
 Accessing and resetting trip data [163](#)
 Resetting the G-Meter values [165](#)
- 13** Wiper lever
-  Windscreen wipers [180](#)
-  Rain sensor [181](#)
-  To clean the windscreen [182](#)
- 14**  Horn, entire area
- 15**  To adjust the steering wheel [119](#)
- 16**  Unlocking the bonnet, behind the footwell trim [372](#)
- 17**  Opening and closing luggage compartment [88](#)

Around the centre console

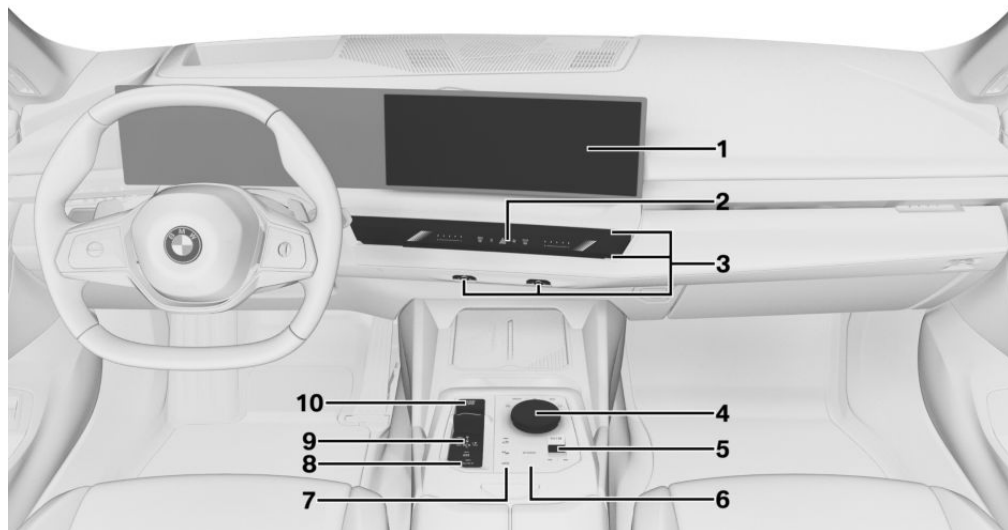

1 Control display [55](#)

2  Hazard warning lights [394](#)



Defrost function [298](#)



Rear window heating [298](#)

3 Ventilation [300](#)

4 Controller with buttons [57](#)

5 Operating elements for entertainment system, see Owner's Handbook for Navigation, Entertainment, Communication [6](#)

 Adjusting the volume

 Station/track forward

 Station/track back

6  My Modes [141](#)

7  Parking assistance systems [260](#)

 Drive settings menu [54](#)

8  Automatic Hold [146](#)



 Parking brake [144](#)

9 Selector lever [136](#)

- 10**  Switching drive-ready state on/off
133

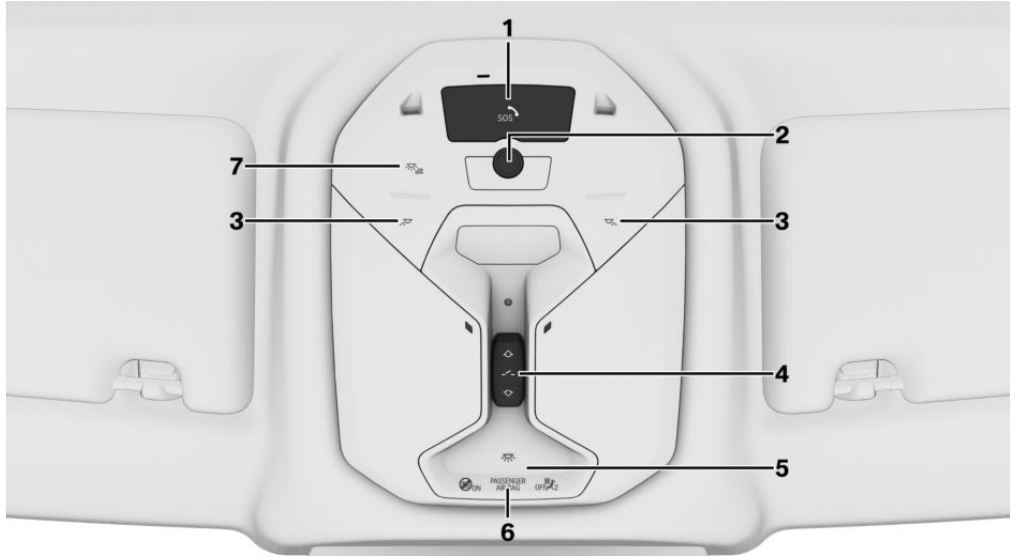
Around the headliner



- | | |
|--|--|
| <p>1  Emergency call, SOS 396</p> | <p>5  Interior lights 178</p> |
| <p>2 Camera
Gesture control 65
Interior camera 312</p> | <p>6  Depending on the national-market version:
Front passenger airbag indicator light 186</p> |
| <p>3  Reading lights 178</p> | <p>7  Interior lighting menu 54</p> |
| <p>4 Glass sunroof</p> | |

Sensors in the vehicle

Vehicle equipment

This chapter describes equipment, systems and functions which are offered or may be offered in future on a model-specific basis, even if they are not included in the vehicle in question.

For further information:

Vehicle equipment, see page 8.

Overview

Depending on the equipment, the following cameras and sensors are installed in the vehicle:

- ▶ Front camera.
- ▶ Camera behind the windscreen.
- ▶ Exterior mirror cameras.
- ▶ Reversing Assist Camera.
- ▶ Front radar sensor.
- ▶ Side radar sensors, front.
- ▶ Side radar sensors, rear.
- ▶ Ultrasonic sensors in the front/rear bumpers.
- ▶ Side ultrasonic sensors.

Cameras

Front camera

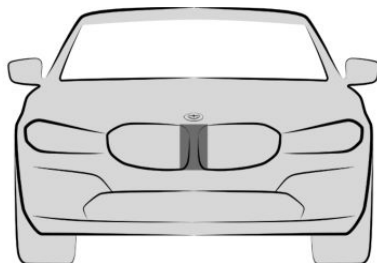

The front camera is located in the radiator grille.

Camera behind the windscreen

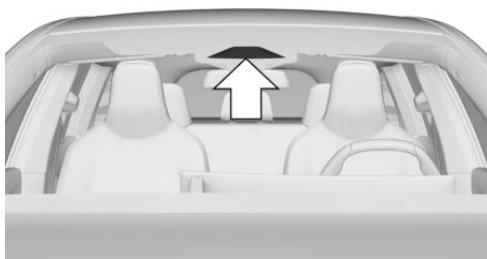

The camera behind the windscreen is located in the area of the interior mirror.

Exterior mirror cameras

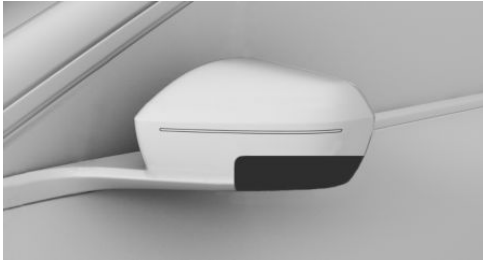

An exterior mirror camera is located under each exterior mirror housing.

Reversing Assist Camera

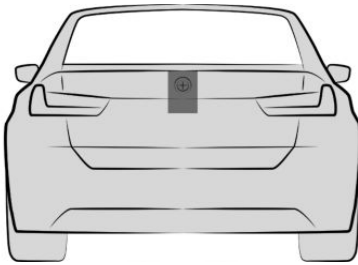

The Reversing Assist Camera is located in the handle strip at the rear of the vehicle.

Functional requirement of the cameras

The areas of the cameras are clean and clear.

For further information:

- ▶ Washing the vehicle, see page 404.
- ▶ Vehicle care, see page 405.

System limits of the cameras

The function of the cameras can be restricted or may indicate something wrong, for example in the following situations:

- ▶ In thick fog, wet conditions or snow.
- ▶ On steep crests or dips or on tight bends.

- ▶ When the camera field of view is covered, for example by a fogged up windscreen or stickers.
- ▶ If the camera lens is dirty or damaged.
- ▶ With the exterior mirrors folded in.
- ▶ With open doors or open luggage compartment.
- ▶ In the case of bright oncoming light or strong reflections, for example if the sun is low in the sky.
- ▶ In the dark.
- ▶ The camera has overheated due to excessive temperatures and temporarily turned off.
- ▶ During the camera calibration process immediately after vehicle delivery.

A Check Control message may be displayed if the system limits are reached.

Radar sensors

Safety information

WARNING

Due to external influences, e.g. interference, the radar sensors of the vehicle and thus also the driving assistance systems can be disturbed. There is a risk of accident. Observe the traffic situation, be ready to take over steering and braking at any time, and actively intervene if the situation warrants it.

Front radar sensor

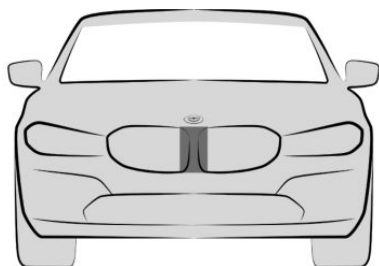

The front radar sensor is located in the radiator grille.

Side radar sensors, front

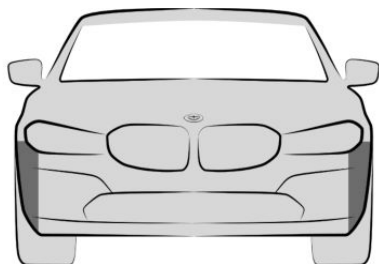

The radar sensors are located on the side of the front bumper.

Side radar sensors, rear

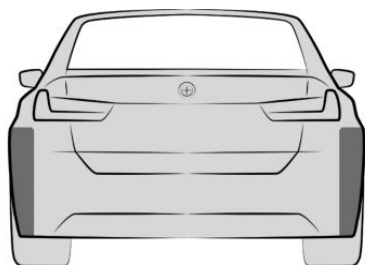

The radar sensors are located in the rear bumper.

Functional requirement of the radar sensors

The areas of the radar sensors are clean and clear.

For further information:

- ▶ Washing the vehicle, see page 404.
- ▶ Vehicle care, see page 405.

System limits of the radar sensors

The function of the radar sensors can be restricted or not available, for example in the following situations:

- ▶ If the sensors are contaminated.
- ▶ In case of iced up sensors.
- ▶ If the sensors are obscured, for example by stickers, foils or a number plate carrier.
- ▶ If the sensors are misaligned, for example due to parking damage.
- ▶ If the radiation range of the sensors is covered, for example by protruding loads.
- ▶ When the field of view of the sensors is covered, for example by garage walls, hedges, snow hills, vehicles or trailers.
- ▶ After work performed incorrectly on the vehicle paintwork near to the sensors.
- ▶ At steep crests or hollows of hills.

A Check Control message may be displayed if the system limits are reached.

Ultrasonic sensors

Ultrasonic sensors, front

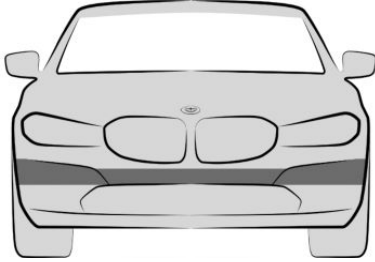

The ultrasonic sensors of the parking assistance systems are located in the front bumper.

Ultrasonic sensors, rear

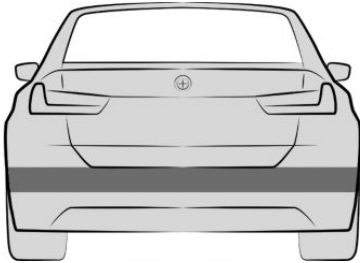

The ultrasonic sensors of the parking assistance systems are located in the rear bumper.

Side ultrasonic sensors

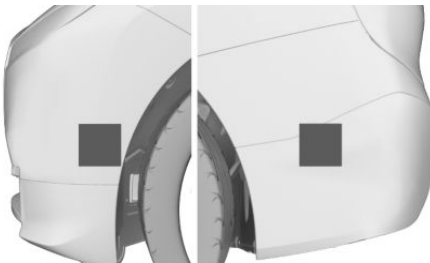

The ultrasonic sensors of the parking assistance systems are located on the side in the front and rear bumpers.

Functional requirement of the ultrasonic sensors

The areas of the ultrasonic sensors are clean and clear.

For further information:

- ▷ Washing the vehicle, see page 404.
- ▷ Vehicle care, see page 405.

System limits of the ultrasonic sensors

The physical limits of ultrasound measurement may be reached when detecting objects in situations involving the following, for example:

- ▷ If the sensors are dirty or covered, e.g. by stickers.
- ▷ If the sensors are misaligned, for example due to parking damage.
- ▷ After work performed incorrectly on the vehicle paintwork near to the sensors.
- ▷ Small children and animals.
- ▷ Persons wearing certain types of clothing, for example a jacket.
- ▷ Obstacles and people at the edge of the driving lane.
- ▷ If there is external interference with the ultrasonic sound, for example by passing vehicles, loud machines or other ultrasonic sources.
- ▷ Certain weather conditions; for example, high air humidity, wet conditions, snowfall, cold, extreme heat or strong wind.
- ▷ For trailer towbars and tow hitches of other vehicles.
- ▷ Thin or wedge-shaped objects.
- ▷ Moving objects.
- ▷ Higher protruding objects, for example projecting walls.
- ▷ Objects with corners, edges and smooth surfaces.

- ▷ For objects with fine surfaces or fine structures, for example wire mesh fences.
- ▷ Objects with porous surfaces.
- ▷ Small and low objects such as boxes.
- ▷ Low objects already displayed, for example, kerbs, can be outside of the detection ranges of the sensors.
- ▷ Soft obstacles or obstacles covered in foam material.
- ▷ Plants or shrubs.
- ▷ In washing bays and car washes.
- ▷ In the event of bumps, for example speed bumps.
- ▷ If there are dense exhaust fumes.
- ▷ The ultrasonic sensors do not take into account loads projecting beyond the outline of the vehicle.
- ▷ If the cover of the trailer tow hitch is incorrectly seated.

A Check Control message may be displayed if the system limits are reached.

Vehicle operating condition

Vehicle equipment

This chapter describes equipment, systems and functions which are offered or may be offered in future on a model-specific basis, even if they are not included in the vehicle in question.

For further information:

Vehicle equipment, see page 8.

General

Depending on the situation, the vehicle is in one of the three states:

- ▷ Rest state.
- ▷ Standby state.
- ▷ Drive-ready state.

Rest state

Principle

If the vehicle is in rest state, it is switched off.

General

The vehicle is in rest state before you open it from outside and once you have left the vehicle and locked it.

Safety information

WARNING

An unsecured vehicle can start moving and roll away. There is a risk of accident. Before leaving the vehicle, secure it in order to prevent it from rolling away.

Observe the following to ensure that the vehicle is secured against rolling away:

- ▷ Apply the parking brake.
- ▷ Turn the front wheels towards the kerb on uphill or downhill gradient.
- ▷ Additionally secure the vehicle on uphill or downhill gradient, for example with a chock.

WARNING

Unsupervised children or pets in the vehicle can set the vehicle in motion and endanger themselves and other road users, for example, by the following actions:

- ▷ Pressing the Start/Stop button.
- ▷ Releasing the parking brake.
- ▷ Opening and closing doors or windows.
- ▷ Engaging selector lever position N.
- ▷ Operating vehicle equipment.

There is a risk of accident or injury. Do not leave children or pets unsupervised in the vehicle. When leaving the vehicle, take the vehicle key with you and lock the vehicle.

Establishing the rest state automatically

The rest state is established automatically, for example in the following situations:

- ▷ After a few minutes, if no operation is performed on the vehicle.
- ▷ When the vehicle battery state of charge is low.
- ▷ Depending on the iDrive setting: one or both of the front doors is opened when leaving the vehicle after a journey.

In some situations, for example during a telephone call or when the low-beam headlight is switched on, the vehicle will not switch automatically to rest state.

Establishing rest state on opening the front doors

After a trip, the rest state can be established by opening the front doors. For this purpose, all passengers must exit the vehicle.

1.  Apps menu
2. "Vehicle"
3. "Doors and windows"
4. "Lock/unlock"
5. "Turn off after opening door"

Establishing the rest state manually

To establish rest state in the vehicle at the end of the journey:



Press and hold the knurled wheel in the centre console until the OFF indicator in the instrument cluster goes out.

Deep sleep mode

Principle

Use the deep sleep mode to prevent discharging of the vehicle battery if the vehicle is not used for a period of several weeks.

In deep sleep mode, the vehicle functions are reduced to the essentials.

Activating deep sleep mode

1.  Apps menu
2. "Vehicle"
3. "System settings"
4. "Deep sleep mode"
5. Select the desired setting.

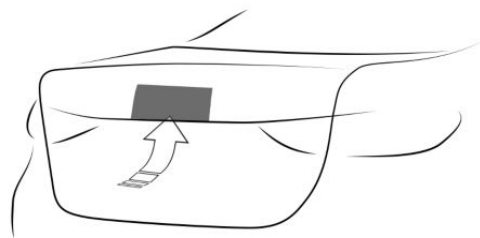

Press the button on the luggage compartment to access the vehicle in deep sleep mode.

Deactivating deep sleep mode

- ▶ Switch off the function on the control display.
- ▶ Drive the vehicle.

Standby state

Principle

When standby state is activated, most functions can be operated while the vehicle is still stationary. Any desired settings can be performed.

General

The vehicle switches to standby state after the front doors are opened from the outside.

Manually establishing standby state

General

The standby state can be switched on again after the rest state has been automatically established.

Via the knurled wheel



Press the knurled wheel in the centre console. The control display and instrument cluster illuminate.

With the Start/Stop button



Press the Start/Stop button. The control display and instrument cluster illuminate.

Display in the instrument cluster

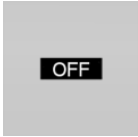

OFF is shown in the instrument cluster. The drivetrain is switched off and standby state switched on.

Drive-ready state

Principle

Switching on drive-ready state corresponds to starting the engine.

General

Some functions can only be operated when the drive-ready state is switched on.

Safety information

DANGER

A blocked exhaust pipe or inadequate ventilation can allow harmful exhaust fumes to enter the vehicle. The exhaust fumes contain pollutants which are colourless and odourless. In enclosed spaces, exhaust fumes can also build up outside the vehicle. There is a danger to life. Keep the exhaust pipe clear and ensure sufficient ventilation.

WARNING

An unsecured vehicle can start moving and roll away. There is a risk of accident. Before leaving the vehicle, secure it in order to prevent it from rolling away.

Observe the following to ensure that the vehicle is secured against rolling away:

- ▷ Apply the parking brake.
- ▷ Turn the front wheels towards the kerb on uphill or downhill gradient.
- ▷ Additionally secure the vehicle on uphill or downhill gradient, for example with a chock.

NOTICE

Repeated attempts to start the engine or starting it several times in quick succession can cause the starter to overheat. Fuel will also be unburned or insufficiently burned, which could cause the catalytic converter to overheat. There is a risk of material damage. Avoid repeated starting in quick succession.

Switching on drive-ready state

General



Drive-ready state is switched on using the Start/Stop button.

Switching on drive-ready state

1. Press the brake.
2. Press the Start/Stop button.

Starting proceeds automatically for a short time and stops as soon as the engine starts.

Most of the indicator and warning lights in the instrument cluster illuminate for varying lengths of time.



Petrol engine

Depending on the motorisation, full drive power may not be available until approx. 30 seconds after the engine is started. In this case, the vehicle will not accelerate in the usual way.

For further information:

Power display, see page 160.

Diesel engine

With the engine cold and at temperatures below 0 °C, 32 °F the starting operation can be delayed slightly due to automatic preheating.

A Check Control message is shown.

After the engine is started, full drive power may not be available until the engine is at operating temperature. Pay attention to the engine temperature display and power display as applicable. In this case, the vehicle will not accelerate in the usual way.

For further information:

- ▷ Engine temperature display, see page 161.
- ▷ Power display, see page 160.

Display in the instrument cluster

The activated drive-ready state is indicated in the instrument cluster, depending on the equipment, by the display of information required for driving or the READY display.

Switching off drive-ready state

1. With the vehicle at a standstill, apply the parking brake.
2. Press the Start/Stop button.

The engine is switched off. The vehicle changes to standby state.

BMW iDrive

Vehicle equipment

This chapter describes equipment, systems and functions which are offered or may be offered in future on a model-specific basis, even if they are not included in the vehicle in question.

For further information:

Vehicle equipment, see page 8.

Display and operating concept

Principle

BMW iDrive is the vehicle's display and operating concept and includes a wide range of functions.

General

Depending on the equipment, the functions can be operated as follows:

- ▶ Via the control display.
- ▶ Via the Controller.
- ▶ Via the touchpad.
- ▶ Via the BMW Intelligent Personal Assistant.
- ▶ Using the operating elements on the steering wheel.

For further information:

Instrument cluster, see page 148.

Safety information

WARNING

Operating integrated information systems and communication devices during a journey may distract you from the traffic situation. You could lose control of the vehicle. There is a risk of accident. Only operate the systems or devices if the traffic situation allows you to do so. Stop if necessary and operate the systems or devices with the vehicle at a standstill.

Main menu

General

The main menu is divided into different areas:

Overview



- 1 Widgets
- 2 Status information
- 3 Configuration bar for main display
- 4 Temperature setting
- 5 Menu bar

Menu bar

Apps menu

 Access to apps and vehicle functions. A filter can be selected. If necessary, change the filter to see the apps you want.

- ▷ "All apps": all apps and functions are displayed.
- ▷ "Infotainment": only infotainment apps are displayed.
- ▷ "Vehicle": only functions for vehicle setting are displayed.
- ▷ "Recently used": the most recently used apps are displayed.

Media menu

 Access to functions of the entertainment system, for example, radio stations or connection with external devices.

Communication menu

 Access to the telephone and message function as well as the connection and management of mobile devices, for example, smartphones.

Navigation menu

 Access to navigation system, destination entry and traffic information. Configurable map views as well as other functions, for example points of interest.

Climate menu

 The Climate menu provides access to all air conditioning functions.

Apple CarPlay® menu

 Depending on the national-market version with connected function: access to Apple CarPlay. Apple CarPlay allows certain functions of a compatible Apple iPhone to be used securely via iDrive.

Android Auto™ menu

 Depending on the national-market version with connected function: access to Android Auto. Android Auto enables certain functions of a compatible Android smartphone to be used securely via iDrive.

Widgets

Widgets show real-time information and dynamic content, for example the latest media content or connected smartphones. The widgets also serve as buttons and allow jumping to the relevant menu.

Main display





The main display shows real-time information and dynamic content, for example, the map of the navigation system. This display also serve as buttons and allows jumping to the relevant menu.

Status information







General

The status field is located in the top area of the control display. Status information is displayed in the form of icons. Various symbols are available depending on vehicle equipment and national-market version.







Telephone status information

Icon	Meaning
	Active call.
	Data transfer not possible.
	Signal strength.
	SIM card missing.

Entertainment status information

Icon	Meaning
	USB audio.
	Bluetooth audio.
	Smartphone audio.
	Connected Music with Spotify.
	Wi-Fi.
	Apple CarPlay.
	Android Auto.







Status information messages

Icon	Meaning
	Number of messages.
	Check Control message.
	Traffic information.
	Suppress private information.
	Do not disturb.
	Message.



For further information:

Owner's Handbook for Navigation, Entertainment, Communication, see page 6.

Other status information

Icon	Meaning
	Sound output active.
	Sound output deactivated.
	Activation word active.
	BMW ID or driver profile.
	Route guidance active.
	Call up quicklist.







Icon Meaning

	Wireless charging active.
	Park Distance Control: sound activated.
	Park Distance Control: sound deactivated.

Digit input and display

Letters and numbers

Letters and numbers can be entered using the controller, the touchpad, control display or voice control depending on the equipment.



Icon	Function
	To switch between upper and lower case.
	To enter a space.
	To switch between languages.
	To use voice input.
	To confirm your digit input.
	Move the entry area to the left or right.

Input comparison

When entering data from a database, for example contacts, the selection is gradually narrowed down with each character entered and supplemented if necessary.

Activating/deactivating functions

Some menu items are preceded by an icon. Selecting the menu item enables or disables the function.

Icon	Meaning
	Function is activated.
	Function is deactivated.

Activating/deactivating audio confirmation

Acoustic feedback is given for some functions, e.g., sounds are emitted when the control display is operated.

1.  Apps menu
2. "Vehicle"
3. "System settings"
4. "Sound"
5. Select the desired setting.

Quick access

The quicklist provides access to the shortcuts, certain settings and app recommendations.

Digit input	Operation
Show	Swipe from top to bottom on the control display. Slide the Controller upwards. Tap the  icon in the status bar.
Hide	Swipe from the bottom up on the control display. Slide the Controller downwards.

Activating/deactivating pop-ups

Pop-ups are automatically shown on the control display for some functions. Some of these pop-ups can be activated or deactivated.

1.  Apps menu
2. "Vehicle"
3. "System settings"
4. "Pop-ups"
5. Select the desired setting.

Shortcuts

General

The iDrive functions can be stored on the shortcuts and called up directly, for example, radio stations, navigation destinations, phone numbers and menu entries.

Saving a function

1. Select the desired function.
2. Press and hold the desired function.
3. "Add to shortcuts"

Shortcuts can only be created with an active BMW ID or a driver profile.

Performing a function

1. Swipe from top to bottom on the control display.
2. Tap the desired shortcut.

The function is carried out immediately. If you have selected a phone number for example, the connection will also be established.

Deleting shortcuts

1. Swipe from top to bottom on the control display.
2. Press and hold the desired shortcut.
3. "Delete shortcut"

Direct access

General

The vehicle has buttons that can be used to access menus for the respective function directly on the control display. Then continue the operation via iDrive.

Overview

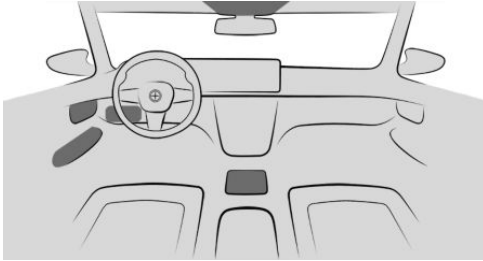

Button Function



Call up the Driving settings menu.



Call up the Exterior lighting menu.



Call up the Interior lighting menu.



Call up the Seat settings menu.



Call up the Doors and windows menu.

BMW Curved Display

Principle

The BMW Curved Display is the single-part display on the instrument panel which is curved towards the driver. The BMW Curved Display comprises the instrument cluster on the driver's side and the control display.

General

Follow the instructions on cleaning the BMW Curved Display in the Care chapter.

For further information:

Care of special parts, see page [407](#).

Overview



- 1 Instrument cluster [148](#)
- 2 Control display [55](#)

Control display

Principle

The iDrive functions are shown on the control display.

Safety information

WARNING

Objects located in front of the control display may slip and damage the control display. There is a danger of injury or material damage. Do not place objects in front of the control display.

Overview

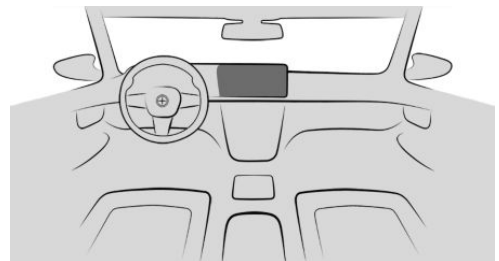

Control display

Switching the control display on/off automatically

The control display is switched on automatically when the vehicle is unlocked or as soon as the control display is required for operation.

In certain situations, the control display is switched off automatically, for example if no operation is performed on the vehicle for several minutes.

Switching the control display on/off manually

1. Swipe from top to bottom on the control display.
2. "Screen off"

Tap the control display to turn it on again.

Adjusting the brightness

1.  Apps menu
2. "Vehicle"
3. "Displays"
4. "Control display"
5. "Brightness at night"
6. Confirm the desired setting.

Depending on the lighting conditions, the brightness control may not be immediately apparent.

System limits

If the control display is exposed to very high temperatures, for example because of strong sunlight, the brightness may be reduced and the control display may even switch itself off. Normal functions will be restored when the temperature is reduced, for example by providing shade or using the air conditioning.

Controller

Principle



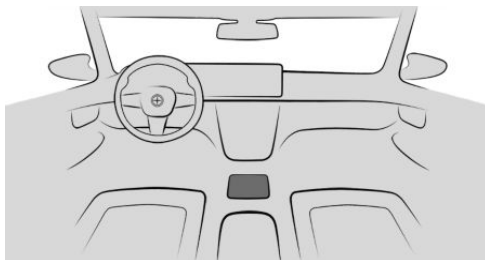

The Controller is used to select menu items and perform settings. The buttons are used to go to menus directly.

Overview



Controller

Buttons on the Controller

Button	Function
	To go to the main menu.
	Go to Media menu.
	To go to the Telephone menu.
	Go to Navigation menu.
	Go to previous menu.

Operation

- ▶ Turn the Controller to switch between menu items, for example.

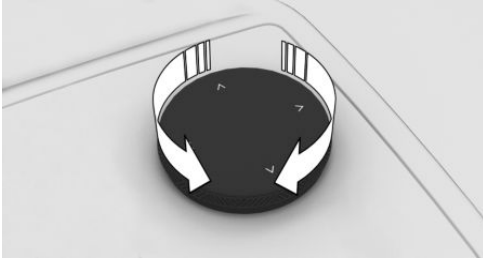

- ▶ Press the Controller to select a menu item, for example.

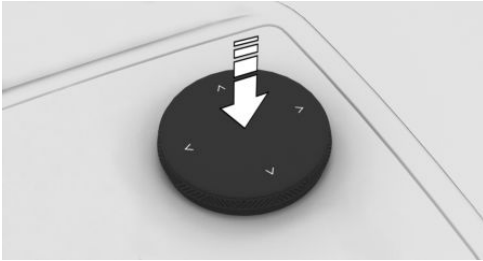

- ▶ Slide the Controller in four directions to change between menus, for example.

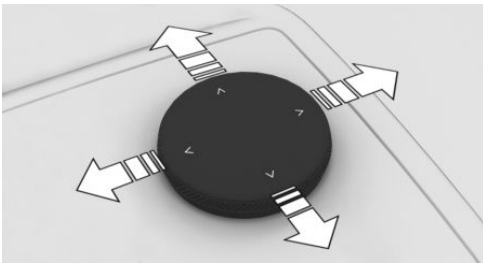

Operation using the Controller

Going to the main menu



Press the key.

The main menu is displayed.

Selecting menu items

1. Turn the Controller until the desired menu item is highlighted.
2. Press the Controller.

Adjusting the main display

You can adapt the main display in the main menu.



1.  Press the button.
2. If necessary, tilt the Controller to select the main display.
3. Tilt the Controller to the right.
4. Select the desired main display.

Selecting widgets

1. Use the controller to select the widgets.
2. Turn the Controller until the desired widget is selected.
3. Press the Controller.

Switching between menus

After selecting a menu item, a new menu is displayed.

- ▶ Slide the Controller to the left.
The current menu closes and the previous menu is displayed.



- ▶  Press the button.

The current menu closes and the previous menu is displayed.

Entering letters and numbers



Digit input

1. Turn the Controller: to select letters or numbers.
2. **OK** : to confirm your digit input.

For further information:

Set system language, see page 62.

Delete the input

Icon	Function
	Press Controller: to delete a letter or number.
	Press and hold the Controller: to delete all letters or numbers.

Using alphabetical lists

For alphabetical lists with more than 30 entries, the letters for which entries exist can be displayed in a letter field.

1. Turn the Controller quickly to the left or right.
2. Select the first letter of the desired entry.
The first entry for the selected letter is displayed in the list.

Operation by touchpad

General

Depending on the equipment, some iDrive functions can be operated with the touchpad of the controller.

The touchpad is located on the Controller. Tap the touchpad with fingers. Do not use any objects.

Selecting functions

1.  Apps menu
2. "Vehicle"
3. "System settings"
4. "Touchpad"
5. Select the desired setting.

Entering letters and numbers

- ▷ Enter characters as they are displayed on the control display.
- ▷ Always enter associated characters, for example accents or dots, so that the letter can be clearly identified.
- ▷ The input options depend on the set language. You may need to enter special characters using the Controller.

Further information:

Set system language, see page 62.

Entering special characters

Function	Operation
Delete a character.	Swipe to the left on the touchpad.
To enter a space.	From the centre of the touchpad, swipe to the right.
To enter a hyphen.	At the top of the touchpad, swipe to the right.
To enter an underscore.	At the bottom of the touchpad, swipe to the right.

Using the map

The navigation system's map can be moved using the touchpad.

Tap the map on the control display and then continue the operation using the touchpad.

Function	Operation
To move the map.	Swipe in the appropriate direction.
To display the menu.	Tap once.

Using alphabetical lists

Alphabetical lists with more than 30 entries permit a direct jump to letters for which an entry exists.

Enter the first letter on the touchpad.

The first entry of the entered letter is displayed in the list.

Operation via control display

General

Depending on the equipment, the control display may be equipped with a touchscreen. It is possible to tap on menu items and widgets. Touch the control display with your fingers. Do not use any objects.

Going to the main menu

 Tap the icon.

The main menu is displayed.

Adjusting the main display

You can adapt the main display in the main menu.

1.  Tap the icon.
2. Swipe the configuration bar on the right side of the screen to the left.
3. Select the desired main display.

Sorting apps

To sort the app icons again, press and hold the desired icon and move it to the desired location.

Switching between menus

After selecting a menu item, a new menu is displayed.

 Select the arrow icon.

The current menu closes and the previous menu is displayed.

Go to context menu

Depending on the menu item, a context menu with additional options can be displayed.

Press and hold the desired menu item.

The menu consists of various areas, such as:



- ▶ "General help": call up the Integrated Owner's Handbook.
- ▶ "Add to shortcuts": define menu item as shortcut.

Entering letters and numbers

Digit input

1. If necessary, tap the  icon or control display.
2. Enter the required letters and numbers.

Delete the input

Icon	Function
	Tap icon: to delete a letter or number.
	Press and hold the icon: delete all letters or numbers.

Using the map

The navigation map can be moved on the control display.

Function	Operation
To move the map.	Swipe in the appropriate direction.
To zoom in/out on the map.	Pinch together or move apart your fingers.
To display the menu.	Tap once.



Using alphabetical lists

For alphabetical lists with more than 30 entries, the letters for which entries exist can be displayed in a letter field.

1. Tap the letter in front of the list.
A letter box is displayed.
2. Tap the first letter of the desired entry.
The first entry for the selected letter is displayed in the list.

BMW Intelligent Personal Assistant

Principle

The BMW Intelligent Personal Assistant is a personal assistant that enables natural voice control of various vehicle functions. The Personal Assistant simplifies the operation of the vehicle by proactively suggesting and automating habits.

General

- ▶ BMW Intelligent Personal Assistant is available depending on the national-market version.
- ▶ The system includes special microphones on the driver's side and the passenger's side.
- ▶ Commands and numbers should be spoken fluently, with the usual emphasis and at a normal volume and speed.
- ▶ >...< identifies commands that can be spoken.

Operating requirements

- ▶ A system language that is supported by the Personal Assistant must be set via iDrive.
Set system language, see page 62.
- ▶ Always say commands in the configured system language.

For the full range of functions, the following functions must be activated, set or booked:

- ▶ Online speech processing, see page 63.
- ▶ All settings under
Data protection, see page 74.
- ▶ Activation word, see page 60.
- ▶ BMW ID or a driver profile.
- ▶ Relevant ConnectedDrive Services via the ConnectedDrive Store.
- ▶ Receive suggestions, see page 63.

Activating voice input

General

Voice input can be activated in various ways:

- ▶  Press the button on the steering wheel briefly.
The microphone on the driver's side is active.
- ▶ Say the activation word.
The microphones on the driver's or front passenger's side are active with the following voice control, depending on where the activation word was spoken.

Then say the command. The activation word and the command can be spoken without pause in one sentence.

Microphone button on steering wheel

1.  Press the button briefly.
2. Say the command.

Activation word

General

Saying the activation word starts the Personal Assistant. The Personal Assistant listens.

Preset activation word

>Hello BMW<: The preset activation word can be activated and deactivated.

1.  Apps menu
2. "Vehicle"
3. "System settings"
4. "Voice control"
5. "Personal Assistant (BMW)"
6. "Activation word"
7. ""Hello BMW""

Personal activation word

In addition to the preset activation word, a personal activation word can be set up with an active BMW ID or a driver profile. The personal activation word can also be changed or deleted.

The activation word should consist of multiple syllables to ensure good detection.

>Hello<: The addition is not necessary during activation word and does not need to be spoken.

1.  Apps menu
2. "Vehicle"
3. "System settings"
4. "Voice control"
5. "Personal Assistant (BMW)"
6. "Activation word"
7. "Personal activation word"
8. "Set"
9. "Start recording"

Activation word from third-party providers

Depending on the national-market version, some third-party providers offer digital voice assistants, e.g. Siri or Amazon Alexa.

In order to use Siri, the smartphone must be connected via Apple CarPlay.

In addition to the BMW preset or personal activation word, the activation word of voice assis-

tants from connected third-party providers can be used.

1.  Apps menu
2. "Vehicle"
3. "System settings"
4. "Voice control"
5. "Additional speech assistants"
6. Select the desired setting.

Cancelling voice input



- ▶  Press the button on the steering wheel again.
- ▶ >Cancel<
- ▶ Slide the Controller to the right or left.
- ▶ Press the Controller.

Possible commands

General

Commands can be used to give instructions or ask questions where the Personal Assistant provides support.

For example, it is possible to call contacts, navigate to an address, make settings or ask questions about the vehicle function. Most vehicle functions can be operated by voice commands, e.g., Park Assist.

Most of the contents on the control display, for example menu items and list entries, can be said as commands.

Help for voice control

- ▶ >Voice commands<: to have voice command options read aloud.
- ▶ >General information on voice control<: have information on the operating principle of the voice control announced.

- ▶ ›Help‹: have tips and example commands for voice control announced.
- ▶ Additional example commands for the current context are displayed in the widget of the BMW Intelligent Personal Assistant.

Sample commands

- ▶ ›Call John Smith‹
- ▶ ›Drive me to Heathrow airport‹
- ▶ ›Play a classical music station‹
- ▶ ›Is my tyre pressure still okay?‹
- ▶ ›Activate climate control‹
- ▶ ›Increase the ACC distance‹
- ▶ ›Sport mode‹

Further example commands can be displayed on the Control Display.

1.  Apps menu
2. "All apps"
3. "Personal assistant"
4. "Help"
5. "Example commands"

Sample commands for the current context are displayed in the widget of the BMW Intelligent Personal Assistant.

For further information:

Adapting widgets, see page 59.

Menu items

Menu items can be called up directly via the Personal Assistant. Speak the menu items as they are displayed on the Control Display. When speaking the menu items, the order of the menus does not have to be observed.

1. Activate the voice input.
2. ›Media‹
3. ›Saved stations‹

The saved stations are displayed on the control display.

Owner's Handbook by voice control

It is possible to ask simple questions about the vehicle functions and about operating the vehicle.

The voice control system and the feedback it provides are not a substitute for the printed or Integrated Owner's Handbook. The function is available depending on the national-market version. The speech recognition function and the quality of the feedback may vary.

Example command: ›How do you disable the front passenger airbag?‹

The Personal Assistant gives a response. Where applicable, the section of the Integrated Owner's Handbook is displayed on the control display if the vehicle is at standstill.

Settings

Setting the system language

1.  Apps menu
2. "Vehicle"
3. "System settings"
4. "Language"
5. Select the desired setting.

Setting the response length

You can set the Personal Assistant to use the standard dialogue or a short version. In case of the short version, the announcements by the Personal Assistant are played back in an abbreviated version.

1.  Apps menu
2. "Vehicle"
3. "System settings"
4. "Voice control"
5. "Personal Assistant (BMW)"
6. "Response length"
7. Select the desired setting.

Speaking during voice output

It is possible to answer during inquiries of the Personal Assistant. The function can be deactivated if the feedback is frequently cancelled inadvertently, for example due to background noise or conversations in the vehicle.

1.  Apps menu
2. "Vehicle"
3. "System settings"
4. "Voice control"
5. "Personal Assistant (BMW)"
6. "Speaking during voice output"

Suggestions

General

The Personal Assistant provides support with individual suggestions.

Activating/deactivating suggestions

1.  Apps menu
2. "Vehicle"
3. "System settings"
4. "Voice control"
5. "Personal Assistant (BMW)"
6. "Receive suggestions"

Adapting suggestions

The suggestions can be adapted, e.g. for which category suggestions are made or whether an audio signal is output.

1.  Apps menu
2. "Vehicle"
3. "System settings"
4. "Voice control"
5. "Personal Assistant (BMW)"
6. Select the desired setting.

Online speech processing

Online speech processing improves the quality of the speech recognition and search results for points of interest. To use the function, data is sent across an encrypted connection to a service provider where it is delete stored. An active ConnectedDrive contract is required for online speech processing. ConnectedDrive is available depending on the national-market version. Online speech processing is not available in all languages.

1.  Apps menu
2. "Vehicle"
3. "System settings"
4. "Voice control"
5. "Personal Assistant (BMW)"
6. "Online speech processing"

Adjusting the visualisation

The visualisation of the Personal Assistant can be adjusted.

1.  Apps menu
2. "Vehicle"
3. "System settings"
4. "Voice control"
5. "Personal Assistant (BMW)"
6. "Visualisation"

Voice control from third-party providers

Depending on the equipment, third-party voice control can be activated by pressing and holding the microphone button on the steering wheel.

1.  Apps menu
2. "Vehicle"
3. "System settings"
4. "Voice control"

5. "Long press"
6. Select the desired setting.

Adjusting the volume

Turn the volume control button during the spoken instructions until the desired volume is obtained.

The volume setting is retained even if you change the volume of other audio sources.

Using the voice control of the smartphone

Depending on the device, a smartphone connected to the vehicle can be operated via voice input.

The device must be connected via Apple CarPlay or Android Auto.

1. Press and hold the  button on the steering wheel for approx. 3 seconds.

The voice control of the smartphone is activated.

If activation is successful, a confirmation appears on the control display.

2. Press the  button on the steering wheel to cancel the voice control of the smartphone.

Amazon Alexa Car Integration

Principle

Amazon Alexa Car Integration is available depending on the equipment and national-market version. Alexa is a digital assistant from Amazon. Amazon Alexa Car Integration allows Alexa to be used in the vehicle. For safety reasons, some Alexa functions may only have limited availability in the vehicle while driving.

Operating requirements

- ▷ A BMW ID or driver profile is activated.
- ▷ An active Amazon account exists.

Activating Amazon Alexa Car Integration

Amazon Alexa Car Integration is activated in the vehicle and, if applicable, in the My BMW App.

To set it up, follow the instructions in the Amazon Alexa app in the vehicle.

1.  Apps menu
2. "All apps"
3. "Amazon Alexa"
4. Select the desired setting.

Once set up, Amazon Alexa can be used in the vehicle as follows:

Say the activation word Alexa and the desired command.

Information about the active function appears on the control display. If the function is impaired, reconnect Bluetooth and Wi-Fi if necessary.

Automating habits

General

The Personal Assistant can automate routines, for example, the automatic opening of windows at the same place. This involves creating rules that can be activated and deactivated at any time.

Activating/deactivating routines

1.  Apps menu
2. "All apps"
3. "Automate habits"
4. Select the desired setting.

System limits

- ▷ The Personal Assistant provides information about vehicle functions that may not be installed in the vehicle.
This also applies to safety-relevant functions and systems.
- ▷ Certain noises may be detected and could cause problems. Keep doors and windows closed.
- ▷ Noises from the front passenger or other passengers can impair the system. Avoid background noise in the vehicle while you are speaking.
- ▷ Strong dialects may prevent speech recognition from working properly.
- ▷ A poor data line influences the response time of the Personal Assistant and the Search.

BMW gesture control

Principle

BMW gesture control enables some iDrive functions to be operated simply by moving your hands.

Overview



The camera in the headliner detects gestures made in the area of the centre console at the height of the control display.

The camera of the gesture control uses an invisible Class 1 laser.

Activating/deactivating gesture control

1.  Apps menu
2. "Vehicle"
3. "System settings"
4. "Gesture control"
5. "Gesture control"







Settings



1.  Apps menu
2. "Vehicle"
3. "System settings"
4. "Gesture control"
5. Select the desired setting.

Performing gestures

- ▷ Perform the gestures under the interior mirror and to the side of the steering wheel.
- ▷ Perform the gestures clearly.
- ▷ The gestures can also be performed from the passenger's side.

Possible gestures

Gesture	Operation	Function
	<p>Move extended index finger forward and backward in the direction of the control display.</p>	<p>To accept phone call. To select the highlighted entry of a list during voice input. To confirm the pop-up.</p>
	<p>Swipe hand in front of the control display in the direction of the front passenger seat.</p>	<p>To reject phone call. To close the pop-up. To end voice input.</p>
	<p>Move extended index finger slowly in a clockwise circle. Gesture is detected after approximately one circular movement.</p>	<p>To increase the volume.</p>
	<p>Move the extended index finger slowly counter-clockwise in a circle. Gesture is detected after approximately one circular movement.</p>	<p>To reduce the volume.</p>
<p>Depending on the equipment:</p> 	<p>Bring thumb and index finger together and move the hand to the right or left.</p>	<p>Turn vehicle in the Live Vehicle view. 3D View: rotate camera view. This gesture is only possible with the vehicle at standstill.</p>
	<p>Move fist with thumb extended to the left back and forth.</p>	<p>To skip back. The previous music track is played.</p>
	<p>Move fist with thumb extended to right left back and forth.</p>	<p>Skip function forwards. The next music track is played.</p>

Gesture	Operation	Function
	With the index and middle fingers extended, point into the direction of the control display.	Perform individually assignable gesture.
	Stretch out all five fingers, make a fist and then stretch out all five fingers again.	Perform individually assignable gesture.

Assigning a gesture individually

General

Two gestures can be assigned individually and can be set as a shortcut for certain functions, for example:

- ▶ Route guidance to home address.
- ▶ Mute/playback.
- ▶ Control display on/off.

Gesture shortcuts can only be created with an active BMW ID or a driver profile.

Setting a gesture shortcut

The desired function can be selected directly in any menu and set as a shortcut.

1. Press and hold the desired menu item.
2. "Add to gesture shortcuts"
3. Select the desired gesture.

Selecting the function

Some defined functions can be selected directly in the menu for gesture control.

1.  Apps menu
2. "Vehicle"
3. "System settings"
4. "Gesture control"

5. "Point two fingers at display" or "Show five-o-five fingers"
6. Select the desired setting.

System limits

Detection of gestures by the camera in the headliner can be disrupted under the following circumstances:

- ▶ The camera lens is covered.
- ▶ There are objects on the interior mirror.
- ▶ The camera lens is dirty; clean the camera lens.
Sensors and camera lenses, see page 405.
- ▶ The gesture is performed outside the detection range.
- ▶ Wearing of gloves or jewellery.
- ▶ Smoking in the interior.

Connecting mobile devices to the vehicle

Principle

The vehicle offers various types of connections for using mobile devices. Which connection type to select depends on the mobile device and the function you wish to use.

General

Detailed information on functions and connection types can be found in the following media from the Owner's Handbook under the specified keyword:

- ▶ Integrated Owner's Handbook in the vehicle.
- ▶ Printed Owner's Handbook for Navigation, Communication, and Entertainment.

The following information sources can also be used:

- ▶ Driver's Guide app.
- ▶ Driver's Guide Web.

Safety information







WARNING



Operating integrated information systems and communication devices during a journey may distract you from the traffic situation. You could lose control of the vehicle. There is

a risk of accident. Only operate the systems or devices if the traffic situation allows you to do so. Stop if necessary and operate the systems or devices with the vehicle at a standstill.

Overview

The following list shows possible functions and the appropriate connection types for them. The range of functions depends on the vehicle equipment and the mobile device.

Function	Connection type	Icon on the control display
Making calls using the hands-free system. Operating telephone functions via iDrive. Keyword: calling via Bluetooth.	Bluetooth. Keyword: Bluetooth connection.	
Playing music from a USB device. Keyword: audio.	Bluetooth audio. Keyword: Bluetooth connection.	 
Calling without a mobile phone. Keyword: calling with Personal eSIM.	Personal eSIM. Keyword: Personal eSIM.	 
Data exchange between mobile device and vehicle.	Wi-Fi. Keyword: vehicle Wi-Fi.	
Use Internet access via the personal hotspot.	Wi-Fi via personal hotspot. Keyword: personal hotspot.	

Function	Connection type	Icon on the control display
Operate Apple CarPlay via iDrive and by voice commands. Keyword: Apple CarPlay preparation.	Bluetooth and Wi-Fi. Keyword: Bluetooth connection and vehicle Wi-Fi.	
Operate Android Auto via iDrive and by voice control. Keyword: Android Auto preparation.	Bluetooth and Wi-Fi. Keyword: Bluetooth connection and vehicle Wi-Fi.	
Playing music from a USB device. Keyword: audio.	USB. Keyword: USB connection. For further information: USB port, see page 309 .	

BMW Remote Software Upgrade

Vehicle equipment

This chapter describes equipment, systems and functions which are offered or may be offered in future on a model-specific basis, even if they are not included in the vehicle in question.

For further information:

Vehicle equipment, see page 8.

BMW Remote Software Upgrade

Principle

Remote Software Upgrade can be used to update the entire software of the vehicle. This makes new functions, functional enhancements or quality improvements available.

General

BMW recommends carrying out the Remote Software Upgrade as soon as it becomes available.

Safety information

WARNING

Unsupervised children or pets in the vehicle can set the vehicle in motion and endanger themselves and other road users, for example, by the following actions:

- ▷ Pressing the Start/Stop button.
- ▷ Releasing the parking brake.
- ▷ Opening and closing doors or windows.
- ▷ Engaging selector lever position N.
- ▷ Operating vehicle equipment.

There is a risk of accident or injury. Do not leave children or pets unsupervised in the vehicle. When leaving the vehicle, take the vehicle key with you and lock the vehicle.

Operating requirements

- ▷ Active ConnectedDrive contract.
- ▷ The integrated SIM card in the vehicle has been activated.
- ▷ Mobile reception.
- ▷ A consent for the transmission of the corresponding data was given in the Data Protection menu.

For further information:

Data protection, see page 74.

Search for an upgrade

Operating requirements

The standby state must be turned on to search for a Remote Software Upgrade.

Automatic search

The vehicle regularly searches for updates in the background.

Manual search

1.  Apps menu
2. "All apps"
3. "System settings"
4. "Remote Software Upgrade"
5. "Search for upgrades"
6. Follow the instructions on the control display.

Download of an upgrade

Automatic download

If available, the data for a Remote Software Upgrade is automatically downloaded to the vehicle. No consent to download is required.

Via the My BMW app

If an upgrade is available, information about the new software version is displayed in the My BMW app.

The data for the upgrade can then be downloaded to a mobile device, for example via an existing Wi-Fi connection.

The data can then be transferred from the mobile device to the vehicle.

This transmission method accelerates the download of the data, for example in areas with limited mobile network availability.

1. Download the upgrade in the My BMW app to the smartphone.
2. Follow the instructions in the My BMW app.
3. The smartphone is connected to the vehicle via Bluetooth audio and Wi-Fi.

The data transfer of the upgrade from the mobile device to the vehicle takes place both while driving and when stationary. Depending on the data volume of the upgrade, it may be necessary to drive the vehicle to complete the transmission.

4. Follow the instructions on the control display.

For further information:

For information on connecting mobile devices with the vehicle, see Owner's Handbook for Navigation, Entertainment, Communication.

Release notes

General



The release notes describe the updates included in the Remote Software Upgrade. The ver-

sion information can be shown on the control display while downloading and following successful completion of the installation.

This information is also available in the ConnectedDrive customer portal.

Displaying information

Display in the vehicle:





1.  Apps menu
2. "All apps"
3. "System settings"
4. "Remote Software Upgrade"
5.  Display currently installed version: "Installed version:"
 -  Display new available version: "Info on version"
6. Follow the instructions on the control display.

Display in the ConnectedDrive customer portal on the Internet:

www.bmw-connecteddrive.com.

Installing the upgrade

General

-  Installing the remote software upgrade may cause software modifications not made by the vehicle manufacturer to be deleted, such as increases in performance.
-  Modifications to the on-board power supply of the vehicle, for example to control units that have not been made by the manufacturer of the vehicle, can cause the installation to malfunction.
-  The installation does not occur until the consent was given.
-  The installation can take around 20 to 30 minutes.
-  Installation cannot be interrupted.

- ▷ The vehicle cannot be used during installation.
- ▷ You may leave the vehicle during installation.

Prerequisites for the installation

- ▷ The vehicle battery is sufficiently charged.
- ▷ The outside temperature is above -10 °C, 14 °F.
- ▷ The vehicle is parked on level ground.
- ▷ The hazard warning lights are switched off.
- ▷ The selector lever position P is engaged.
- ▷ The engine is turned off and sufficiently cooled down.

If applicable, follow the notes for further prerequisites on the control display.

Some prerequisites can be set automatically by the vehicle. Observe the information on the control display.

If the prerequisites are not met, for example a sufficient vehicle battery charge state, the upgrade will not be offered for installation.

Look out for an offer to install, for example after driving for a long period.

Preparing the vehicle

- ▷ Park the vehicle safely away from the public road.
- ▷ Cellular network reception must be ensured so that a fault message can be sent to the vehicle manufacturer, for example if the installation is terminated.
- ▷ Close the windows.
- ▷ Closing the luggage compartment
- ▷ Remove devices that consume energy, for example mobile phone.
- ▷ Disconnect the trailer or load carrier.
- ▷ The vehicle key must be located in the vehicle for the consent for installation.

- ▷ Switch off the exterior lights.
- ▷ Remove the devices connected to the socket for on-board diagnosis.

Install immediately

The upgrade can be installed immediately when all prerequisites have been met.

1.  Apps menu
2. "All apps"
3. "System settings"
4. "Remote Software Upgrade"
5. "Start upgrade now"
6. Follow the instructions on the control display.

Installing with timer

At the end of the journey, a timer can be used to install the upgrade automatically at a configured time, for example, during the night. It may make sense to install later to meet functional requirements, such as a sufficiently cooled engine.

1.  Apps menu
2. "All apps"
3. "System settings"
4. "Remote Software Upgrade"
5. Select the desired settings.

The installation starts automatically when:

- ▷ All prerequisites for the installation have been established correctly.
- ▷ All prerequisites continue to be met at the time of installation.

The timer is turned off when the drive-ready state is turned on.

Install via the My BMW app

If all the prerequisites are met, the installation of the upgrade can also be started via the My BMW app.

Follow the instructions in the My BMW app.

Functional limitations

During the upgrade, many of the functions are temporarily unavailable, for example:

- ▷ Hazard warning lights.
- ▷ Central locking system and, if necessary, Comfort Access.
- ▷ Side lights.
- ▷ Horn.
- ▷ Alarm system.
- ▷ Emergency call.
- ▷ Window lifters.
- ▷ Sun protection.
- ▷ Fuel filler flap lock.
- ▷ Operating the tailgate or boot lid.
- ▷ Exit warning, if necessary.

In vehicles with frameless doors, the window may no longer close completely.

The driver's door can be unlocked and locked from outside with the integrated key.

After successful upgrade

The vehicle can be used again immediately.

Purchased services, e.g. Real Time Traffic Information or Remote Services, are automatically reactivated during your next drive.

After an extended stationary period, charge the vehicle battery with an extended drive.

Malfunction

In the event of a malfunction, follow the instructions on the control display or in the My BMW app.

If the malfunction cannot be rectified, contact an authorised Service Partner or another qualified Service Partner or a specialist workshop.

Validity of Owner's Handbook

Vehicle production

When the vehicle leaves the factory, the contents of the printed Owner's Handbook are up to date.

After a software update in the vehicle

After a vehicle software update, for example, via Remote Software Upgrade, the Integrated Owner's Handbook for the vehicle will contain the latest information.

Personal settings

Vehicle equipment

This chapter describes equipment, systems and functions which are offered or may be offered in future on a model-specific basis, even if they are not included in the vehicle in question.

For further information:

Vehicle equipment, see page 8.

Data protection

Data transfer

Principle

The vehicle offers various services which require data to be transferred to BMW or a service provider.

General

Data transfer can be deactivated for some services. If data transfer has been deactivated for a service, then that service cannot be used.

Settings

Data transfer can be configured individually in various stages or for individual services.

1.  Apps menu
2. "Vehicle"
3. "System settings"
4. "Data privacy"
5. Select the desired setting.

Deleting personal data in the vehicle

Principle

Depending on use, the vehicle stores personal data such as saved radio stations. This personal data can be permanently deleted using iDrive.

General

Depending on the equipment, the following data is deleted:

- ▶ BMW IDs or driver profiles.
- ▶ Saved radio stations.
- ▶ Stored shortcuts.
- ▶ Navigation, for example saved destinations.
- ▶ Phone book.
- ▶ Online data, for example favourites, cookies.
- ▶ Office data, for example voice memos.
- ▶ Login accounts.
- ▶ Digital keys.

It may take up to 15 minutes in total to delete data. The vehicle is also removed from the My BMW App and the ConnectedDrive customer portal so that remote functions can no longer be used.

Operating requirements

- ▶ Data can only be deleted with the vehicle at a standstill.
- ▶ The vehicle key must be in the vehicle.

Deleting data

Personal data in the vehicle is deleted when the vehicle is reset to its factory settings.

For further information:

Reset vehicle data, see page 75.

Resetting vehicle data

All individual settings can be reset to the factory settings when drive-ready state is switched off. The data can only be deleted with the vehicle at a standstill. The vehicle key must be in the vehicle.

1.  Apps menu
2. "Vehicle"
3. "System settings"
4. "Reset vehicle data"
5. "Reset vehicle data"

If synchronisation of settings has been activated for a BMW ID in the vehicle, the personal settings are retained in the BMW Cloud.

BMW ID/driver profiles

Principle

In ConnectedDrive countries, the BMW ID is the personal login for all relevant offers for the BMW brand. The BMW ID can be used in the vehicle to store and activate personal vehicle settings.

In non-ConnectedDrive countries, the personal vehicle settings can be stored in driver profiles. If a vehicle is used by several people, each person can use their own BMW ID in the vehicle. If a BMW ID is activated, the stored settings for this are applied to the vehicle.

General

The BMW ID must be registered once. A BMW ID can be registered via the My BMW app, in the ConnectedDrive Portal or at the authorised Service Partner.

A driver profile is created in the vehicle.

Many of the settings that are stored for a BMW ID in the vehicle can be synchronised with the BMW Cloud. This makes these settings avail-

able in any vehicle where the same BMW ID is used to log in.

The vehicle can store seven BMW IDs or seven driver profiles.

Driver recognition enables a BMW ID or driver profile to be activated as soon as the vehicle is unlocked. For this, a vehicle key or a digital key must be linked to the BMW ID or the driver profile. After unlocking, the BMW ID or driver profile can be changed.

If no BMW ID or driver profile is activated when the vehicle is unlocked, the vehicle is in the guest profile.

Operating requirements

For a BMW ID to be created, changed, deleted or edited, the vehicle must be at a standstill.

The login in the vehicle with a BMW ID and synchronisation with the BMW Cloud are only possible when the vehicle has cellular network reception.

Welcome window

After unlocking the vehicle, a Welcome window is shown on the control display. The type of the welcome depends on the following prerequisite:

- ▶ The vehicle does not have a stored BMW ID or driver profile:
 - The welcome is neutral. An option to add a BMW ID or create a driver profile is offered.
- ▶ The vehicle key or the digital key has not been assigned to a BMW ID or a driver profile:
 - The welcome is neutral. The stored BMW IDs or the stored driver profiles are offered for selection. Additionally, it is possible to add a new BMW ID or create a new driver profile.
- ▶ A BMW ID or a driver profile has not been assigned to the vehicle key or the digital key :



The welcome is personalised, the stored settings are activated. The BMW ID or the driver profile can be changed.

As soon as the drive-ready state is turned on or the control display is tapped outside of the welcome window, the welcome will be hidden.

Adding the BMW ID

1.  Tap the icon for the BMW ID or the personal image in the status bar.
2. "Add BMW ID"
3. Scan the displayed QR code with a smartphone.
4. Follow the instructions on the smartphone.
 - ▶ If the My BMW app is installed on the smartphone and the BMW ID is stored, the BMW ID is automatically transferred to the vehicle.
 - ▶ If there is no BMW ID available yet, a new BMW ID can be registered.
5. Select whether further settings should be made, for example, to define the desired driver recognition.
 - ▶ In order to define driver recognition, the corresponding vehicle key or the corresponding digital key must be located in the vehicle.

Driver recognition can be defined or changed in the settings at a later point in time.

6. Make further settings if necessary.

Alternatively, the BMW ID can be registered by the authorised Service Partner and added to the vehicle. The BMW ID must then be confirmed on the control display of the corresponding vehicle.

The vehicle is added to the user's My BMW app.

The vehicle is added to the user's My BMW app.

Confirming the BMW ID

If the BMW ID has been created by the authorised Service Partner and added to the vehicle, the BMW ID must then be confirmed in the vehicle:

1. Select the BMW ID.
2. Scan the QR code shown.
3. Follow the instructions on your smartphone.

My BMW App

If a BMW ID has been added to a vehicle, the vehicle is automatically added to the My BMW app. This means that functions of the My BMW app can be used for this vehicle. This requires the My BMW app to be used with the same BMW ID.

Alternatively, a vehicle can be added to the My BMW app by the authorised Service Partner. In this case, the BMW ID must then be confirmed on the control display of the corresponding vehicle.

In rare cases, the use of My BMW App functions for this vehicle may be restricted. A further note is shown on the control display.

Creating a driver profile

Driver profiles can be created in countries where BMW ConnectedDrive is not available.

1.  Tap the icon or personal picture in the status bar.
2. "Add driver profile"
3. Enter the name for the driver profile.
4. Select the desired setting:
"Transfer settings"

If the vehicle is using the guest profile, the settings of the guest profile will be applied.

Main user

The main user is the person who first enters their BMW ID into the vehicle and the vehicle

into the My BMW App. Alternatively, the main user can be specified by the authorised Service Partner.

The main user has access to the following settings, for example:

- ▷ Remove BMW IDs stored in the vehicle.
- ▷ Transfer the role of the main user to another BMW ID.
- ▷ Make vehicle-wide privacy settings.
- ▷ Creation of the digital master key.

For further information:

BMW Digital Key, see page 94.

Automatic driver recognition

If driver recognition has been defined, automatic activation of the BMW ID or driver profile is triggered by the following activities:

- ▷ By unlocking the vehicle using the assigned vehicle key button.
- ▷ By unlocking the vehicle using an outside door handle. The assigned vehicle key or the assigned digital key must be carried.
- ▷ By automatic unlocking when approaching the vehicle. The assigned vehicle key or the assigned digital key must be carried. Depending on the national-market version, it may not be possible to recognise the digital key.

If there are several vehicle keys or digital keys in the vicinity of the vehicle, the activation of the BMW ID or the driver profile takes place according to the following priority:

- ▷ The key that unlocks the vehicle triggers the activation of the assigned BMW ID or the assigned driver profile.
The guest profile is activated when the vehicle is unlocked using a key that is not assigned to a BMW ID or driver profile.
- ▷ If a vehicle key and a digital key are detected at the same time, the digital key trig-

gers the activation of the assigned BMW ID or the assigned driver profile.

- ▷ If another key is detected on the driver's door after activating the BMW ID or the driver profile, the BMW ID or the driver profile of the last key detected is activated.

If no BMW ID and no driver profile are assigned to this key, the guest profile is activated.

Synchronisation of settings

If synchronisation is switched on, settings are continuously synchronised from the following areas, for example:

- ▷ BMW ID, e.g. profile picture.
- ▷ Navigation, e.g. last destinations, home address or map settings.
- ▷ Media, e.g. favourites or stored radio stations.
- ▷ iDrive, e.g. main menu configuration, language or units.
- ▷ Personal assistant, e.g. suggestions or activation word.
- ▷ Exterior lights, e.g. one-touch signalling and home lights.



Settings from the following areas are only synchronised when you log in for the first time:

- ▷ Seating and climate comfort, e.g. driver's seat position or temperature setting.
- ▷ Privacy menu.

Selecting the BMW ID/driver profile

If it was not possible to recognise the BMW ID or driver profile when unlocking the vehicle, the BMW ID or driver profile is selected on the welcome window.

The BMW ID or driver profile can be changed at any time via iDrive:



1.  Tap the icon or personal picture in the status bar.
2.  "Change BMW ID"
 "Change driver profile"
3. Select the BMW ID or driver profile.
4. If necessary, enter the PIN.

The BMW ID or the driver profile are activated, the stored settings are loaded.





Guest profile

The guest profile can be activated and changed by anyone.



The guest profile is automatically active in the following cases:

-  A BMW ID has not yet been added or a driver profile has not yet been created.
-  No BMW ID or driver profile has been assigned to the vehicle key or the digital key that was used to unlock the vehicle.





The following limitations apply to the guest profile:

-  Certain functions are not available, for example, navigation functions or saving favourites.
-  The guest profile cannot be renamed.
-  It is not possible to assign a PIN to the guest profile.
-  It is not possible to assign a driver detection to the guest profile.
-  In ConnectedDrive countries, the synchronisation with the BMW Cloud is not possible.

The guest profile is selected in the welcome window or via iDrive:

1.  Tap the icon or personal picture in the status bar.
2.  "Change BMW ID"
 "Change driver profile"
3. "Continue as guest"

Deleting the BMW ID/driver profile

1.  Tap the icon or personal picture in the status bar.
2.  "Manage BMW IDs"
 "Change driver profile"
3.  Tap the icon of the desired BMW ID or the desired driver profile.

Removing a BMW ID from the vehicle causes the vehicle to be removed from the My BMW app. If the BMW ID has been synchronised with the BMW Cloud, the data stored in the BMW Cloud is retained after the BMW ID is deleted. If the currently active BMW ID is removed, the guest profile is activated.

Removing a vehicle from the My BMW app removes the corresponding BMW ID from the vehicle. If the BMW ID was synchronised with the BMW Cloud, the BMW ID data stored on the BMW Cloud will be retained.

If the vehicle is removed from the main user's My BMW app, it will also be removed from the other users' My BMW apps. The corresponding BMW IDs are removed from the vehicle.

If the vehicle is reset to the factory settings, the vehicle is removed from all users' My BMW apps and all BMW IDs are removed from the vehicle.

Transfer of the vehicle key

A vehicle key that is assigned to a BMW ID or a driver profile can be used to view or change the stored personal settings.

Before a vehicle key is transferred to other persons, any assigned driver detection should be cancelled. Changes to the driver detection can be made in the settings of the BMW ID or the driver profile.

The BMW Digital Key provides the option to transfer a digital key to permit other persons the use of your own vehicle.

For further information:

BMW Digital Key, see page 94.

Settings

General

Settings added when adding a BMW ID or creating a driver profile can be changed.

1.  Tap the icon or personal picture in the status bar.
2. "Settings"

The following settings are available for the BMW ID:

- ▷ The type of driver detection.
- ▷ The profile picture.
- ▷ The synchronisation with the BMW Cloud.
- ▷ The personal salutation.

The following settings are available for the driver profile:

- ▷ The type of driver detection.
- ▷ The profile picture.
- ▷ The profile name.

Selecting a profile picture

The profile picture can be selected from the predefined profile pictures.

1.  Tap the icon or personal picture in the status bar.
2. "Settings"
3. "Manage profile picture"
4. "Select profile picture"

For a BMW ID, the personal profile picture can be taken from the profile in the My BMW app. This requires that the synchronisation with the BMW Cloud is activated in the settings. After the profile picture from the My BMW app has been applied, a selection from the predefined pictures is only possible if the profile picture in the My BMW app is deleted or synchronisation is deactivated.

System limits

A clear driver detection via the vehicle key or the digital key may not always be possible, for example in the following cases:

- ▷ If there is a change of driver without the vehicle being locked and unlocked.
- ▷ When multiple vehicle keys or multiple digital keys with an assigned BMW ID or driver profile are located in the outer area on the driver's side of the vehicle.
- ▷ When the vehicle was unlocked from the My BMW app.

The use of personal settings that are stored for a BMW ID in other vehicles is subject to technical limitations. For example, there may be stored settings for a system that is not available in other vehicles, or only in an incompatible version.

Opening and closing

Vehicle equipment

This chapter describes equipment, systems and functions which are offered or may be offered in future on a model-specific basis, even if they are not included in the vehicle in question.

For further information:

Vehicle equipment, see page 8.

Vehicle key

General

The delivery specification includes two vehicle keys, each containing an integrated key.

Each vehicle key contains a replaceable battery.

Depending on vehicle equipment and national-market version, various settings are possible for the button functions.

A BMW ID or a driver profile with personal settings can be assigned to a vehicle key.

To provide information on maintenance requirement, the service data is saved in the vehicle key.

To prevent the vehicle key from being locked in, take it with you whenever you leave the vehicle.

Safety information

 **WARNING**





The vehicle key has a button cell battery. Batteries or button cells can be swallowed and lead to serious or fatal injuries within two hours, for example due to internal burns or chemical burns. There is a danger of injury or danger to life. Keep the vehicle key and bat-

teries out of reach of children. Immediately seek medical help if there is any suspicion that a battery or button cell has been swallowed or is located in any part of the body.

Overview



Buttons on the vehicle key.

Icon	Meaning
	Unlock.
	Lock.
	Depending on the equipment: Open/close the luggage compartment. Open the luggage compartment.
	Home lights, see page 175.

Additional vehicle keys

Additional vehicle keys are available from an authorised Service Partner or another qualified Service Partner or a specialist workshop.

Loss of vehicle keys

A lost vehicle key can be disabled and replaced by an authorised Service Partner or another qualified Service Partner or a specialist workshop.

If a BMW ID or driver profile has been assigned to the lost vehicle key, the connection to this vehicle key must be deleted. A new vehicle key can then be assigned to the BMW ID or driver profile.

Replacing the battery

NOTICE

Unsuitable batteries in a battery-operated device can damage the device. There is a risk of material damage. Always replace the discharged battery with a battery with the same voltage, the same size and the same specification.

1. Press and hold the button, arrow 1, and push the cover, arrow 2, forward and remove it from the side.



2. Remove the battery housing from the vehicle key to the side.



3. Remove the battery from the battery housing.



4. Insert a type CR 2032 3V battery with the positive terminal facing down.

5. Insert the battery housing into the vehicle key.



6. Insert the cover into the vehicle key.

 Dispose of old batteries with an authorised Service Partner, another qualified Service Partner or a specialist workshop, or hand them in to an authorised collection point.

Integrated key

General

The integrated key enables the vehicle to be unlocked without the vehicle key.

Depending on the national-market version, the integrated key fits the glove compartment.

Safety information

WARNING

With some national-market versions, unlocking from the inside requires specific knowledge.

There is a risk of severe or fatal injury if persons or animals remain in the vehicle for extended periods of time, which exposes them to extreme temperatures. Do not lock the vehicle from the outside if there are persons or animals inside. Do not leave babies, toddlers, or animals alone in the vehicle.

Removing the integrated key

1. Press and hold the button, arrow 1, and push the cover, arrow 2, forward and remove it from the side.



2. Slide out the integrated key at the open side of the vehicle key.



3. Remove the integrated key from the vehicle key.

Unlocking the vehicle manually

1. Pull the driver's side door handle outwards with one hand and hold it.

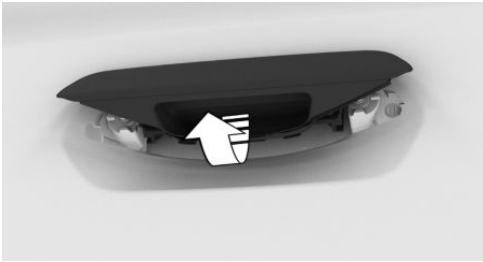

2. Unlock the door by turning the door lock anti-clockwise using the integrated key.



3. Open the driver's door.
4. Press the central locking system button to unlock the other doors.
If the vehicle is de-energised: pull the door openers of the other doors from the inside.

Manually locking the vehicle

General

To avoid locking the vehicle key in the vehicle, do not place the vehicle key into the vehicle.

Locking the vehicle

1. With the integrated key, lock all doors except the driver's door using the side door lock on the front side of the doors.

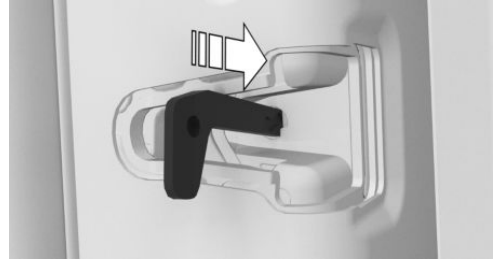

2. Close the locked doors.
3. Using the integrated key, lock the driver's door by turning the door lock clockwise.



4. Close the driver's door.

Alarm system

If the vehicle is unlocked with the integrated key via the door lock, the activated alarm system is triggered when the door is opened.

In this case, use the emergency detection of the vehicle key to switch off the alarm.

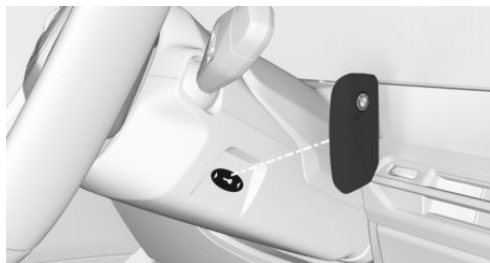

If the doors are manually locked from the inside, the alarm system is not activated.

Emergency detection of the vehicle key



Drive-ready state cannot be switched on if the vehicle key is not detected.



If this happens, proceed as follows:



1. Hold the rear side of the vehicle key against the mark on the steering column. Pay attention to the display in the instrument cluster.
2.  If the vehicle key is detected:
Switch on drive-ready state within 10 seconds.
-  If the vehicle key is not detected:
Slightly change the position of the vehicle key and repeat the procedure.

Malfunction

A Check Control message is shown where applicable.

It may be difficult for the vehicle to detect the vehicle key in some circumstances, including the following:

-  The battery of the vehicle key is discharged.
-  Disruption of the radio link by transmission masts or other equipment transmitting powerful signals.
-  Shielding of the vehicle key by metallic objects.
Do not transport the vehicle key together with metallic objects.

-  Disruption of the radio link by mobile phones or other electronic devices in the immediate vicinity of the vehicle key.
Do not transport the vehicle key together with electronic devices.
-  Interference with the radio transmission caused by the charging process of mobile devices, for example a mobile phone.
-  The vehicle key is located in the immediate vicinity of the wireless charging tray.
Place the vehicle key somewhere else.

If there is a malfunction, the vehicle can be unlocked and locked from the outside with the integrated key. Use the emergency detection of the vehicle key to turn on the drive-ready state.

Access to vehicle interior

Safety information

WARNING

Persons remaining in the vehicle or pets left inside can lock the doors from the inside and lock themselves in. In this case, the vehicle cannot be opened from the outside. There is a danger of injury. Carry the vehicle key with you so that you can open the vehicle from the outside.

WARNING

With some national-market versions, unlocking from the inside requires specific knowledge.

There is a risk of severe or fatal injury if persons or animals remain in the vehicle for extended periods of time, which exposes them to extreme temperatures. Do not lock the vehicle from the outside if there are persons or

animals inside. Do not leave babies, toddlers, or animals alone in the vehicle.

WARNING

Unsupervised children or pets in the vehicle can set the vehicle in motion and endanger themselves and other road users, for example, by the following actions:

- ▷ Pressing the Start/Stop button.
- ▷ Releasing the parking brake.
- ▷ Opening and closing doors or windows.
- ▷ Engaging selector lever position N.
- ▷ Operating vehicle equipment.

There is a risk of accident or injury. Do not leave children or pets unsupervised in the vehicle. When leaving the vehicle, take the vehicle key with you and lock the vehicle.

Actions during unlocking

Depending on the settings, the following functions are performed when unlocking the vehicle:

- ▷ Only the driver's door and the fuel filler flap will be unlocked or all access to the vehicle will be unlocked.
- ▷ The unlocking of the vehicle can be confirmed with a light signal or a sound signal.
- ▷ The welcome light can be turned on when the vehicle is being unlocked.

The following functions are also carried out:

- ▷ If a BMW ID or driver profile was assigned to the vehicle key, this BMW ID or driver profile will be activated.
- ▷ The interior lights are switched on unless they were switched off manually.
- ▷ Depending on the equipment, folded exterior mirrors are folded out.

If the exterior mirrors were folded in using the button inside the vehicle, they are not folded out when the vehicle is unlocked.

- ▷ The anti-theft security system is switched off.
- ▷ The alarm system is switched off.

For further information:

- ▷ For settings, see page 98.
- ▷ Welcome light, see page 174.
- ▷ BMW ID/driver profiles, see page 75.

Actions during locking

Depending on the settings, the following functions are performed when the vehicle is locked:

- ▷ The locking of the vehicle can be confirmed with a light signal or a sound signal.
- ▷ Depending on the equipment, the exterior mirrors can be folded in automatically during locking. If the hazard warning lights are switched on, the exterior mirrors are not folded in.

The following functions are carried out:

- ▷ All the doors, the tailgate and fuel filler flap are locked.
- ▷ The anti-theft security system is switched on. This prevents doors from being unlocked using the door openers.
- ▷ The alarm system is switched on.

If drive-ready state is still switched on when locking, the vehicle horn sounds twice. If this happens, switch off drive-ready state using Start/Stop button.

For further information:

For settings, see page 98.

With the vehicle key

Unlocking the vehicle



Press the button on the vehicle key.

If only the driver's door and the fuel filler flap have been unlocked because of the settings, press the button on the vehicle key again to unlock the other vehicle access points.

The lighting functions may depend on the ambient brightness.

Manually locking the vehicle

1. Close the driver's door.



2. Press the button on the vehicle key. All vehicle access points are locked.

On the outside door handle

Principle

This feature allows you to access the vehicle without having to use the vehicle key.

The vehicle key is automatically detected near the vehicle.

General

The function is available with Comfort Access. Depending on the national-market version, the vehicle can also be unlocked and locked at the outside door handle with compatible smartphones with a digital key.

For further information:

BMW Digital Key, see page 94.

Operating requirements

- ▶ Carry the vehicle key with you, for example, in your trouser pocket.
- ▶ Bluetooth must be activated on the smartphone to unlock and lock with the digital key.
- ▶ To lock the vehicle, the vehicle key must be located outside the vehicle in the vicinity of the doors.
- ▶ After locking, approx. 2 seconds must elapse before unlocking is possible.

Unlocking the vehicle

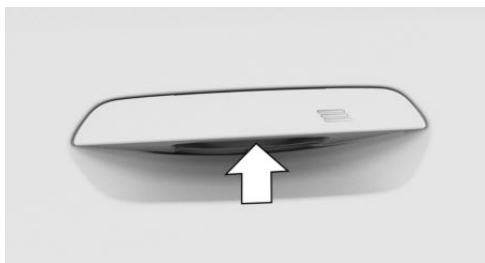

Reach into the handle recess of a front door.

Locking the vehicle

1. Close the driver's door.
2. Touch the grooved surface on the outside door handle of a closed front door with your finger for approx. 1 second without reaching into the handle recess.

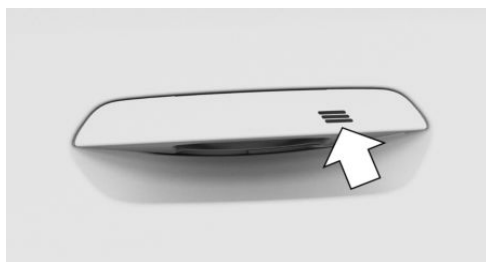

Malfunction

Wet or snowy conditions may disrupt the locking request detection on the outside door handles.

If a fault occurs, unlock and lock the vehicle with the buttons on the vehicle key or with the integrated key.

Touchless unlocking/locking of the vehicle

Principle

The vehicle is unlocked when the driver approaches the locked vehicle with the vehicle key.

If the driver moves away from the unlocked vehicle with the vehicle key, the vehicle is locked.

General

The function is available with Comfort Access.

The vehicle is unlocked when an authorised vehicle key is detected in the unlocking zone.

The vehicle is locked when the vehicle key leaves the locking zone.

Depending on the national-market version, touchless unlocking and locking is also possible for compatible smartphones with a digital key. Bluetooth must be activated on the smartphone to do this.

If the vehicle key remains within the unlocking zone without moving for a prolonged period of time, the vehicle is locked automatically.

If a person is detected on a seat when locking, the following restrictions apply:

- ▶ The vehicle is locked, but not protected against theft.
- ▶ The fuel filler flap remains unlocked.

For further information:

BMW Digital Key, see page [94](#).

Actions during unlocking

If the settings specify that only the driver's door and the charging socket flap will be unlocked, note the following:

The driver's door and charging socket flap will only unlock when the driver is located within the unlocking zone for the driver's door.

For settings, see page [98](#).

Operating requirements

- ▶ Carry the vehicle key with you, for example, in your trouser pocket.
- ▶ Bluetooth must be enabled on the smartphone for contactless unlocking and locking with the digital key.
- ▶ Automatic unlocking and locking must be activated in the settings.
- ▶ Drive-ready state must be switched off.
- ▶ If the vehicle has been in rest state for several days, contactless unlocking/locking is not possible until the vehicle has been driven.

For further information:

For settings, see page [98](#).

With the Key Card

Principle

The Key Card is a chip card on which a digital key is installed. The key card can be used to unlock and lock the vehicle.

For further information:

Key Card, see page [92](#).

General

The Key Card is available with Comfort Access.

Locking/unlocking the vehicle

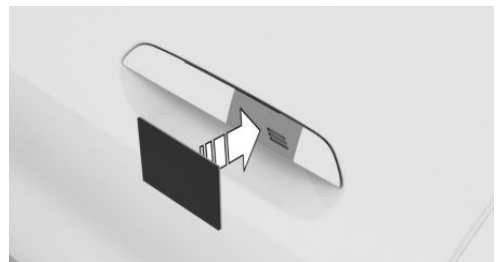

Hold the activated Key Card directly and centrally up against the outside door handle on the driver's door.

When locking the vehicle with the Key Card, make sure that all doors and the luggage compartment are closed.

If the Key Card is not detected, slightly change the position of the Key Card and repeat the process.

With the BMW Digital Key

Principle

Depending on the national-market version and equipment, a digital key can be installed on a compatible smartphone and used to unlock and lock the vehicle.

For further information:

BMW Digital Key, see page 94.

Locking/unlocking the vehicle

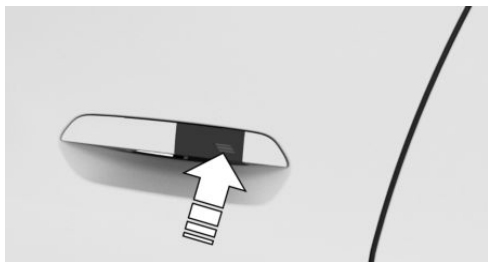

Hold the NFC antenna on the smartphone directly and centrally up against the outside door handle on the driver's door. The position of the NFC antenna will depend on the smartphone model.

When locking the vehicle with the smartphone, make sure that all doors and the luggage compartment are closed.

Frequently Asked Questions

What measures can be taken to enable a vehicle to be opened if the vehicle key has accidentally been locked inside the vehicle?

- ▶ The Remote Services of the app can be used to lock and unlock a vehicle, for example.

This requires an active BMW ConnectedDrive contract and the app must be installed on a smartphone.

- ▶ Unlocking of the vehicle can be requested via the BMW ConnectedDrive call centre.

This requires an active BMW ConnectedDrive contract.

Access to the luggage compartment

General

The luggage compartment may not open when the vehicle is in Valet Parking mode.

For further information:

Valet parking mode, see page 98.

Safety information

⚠ WARNING

Parts of the body can become trapped when the boot lid is operated. There is a danger of injury. When opening and closing, make sure that the movement range of the boot lid is kept clear.

⚠ WARNING

The boot lid swings rearwards and upwards when opened. There is a danger of injury or material damage. When opening and closing, make sure that the movement range of the boot lid is kept clear.

With the vehicle key

General

To prevent the vehicle key from being locked in, do not place it in the luggage compartment.

Depending on the equipment and national-market version, the following settings are possible:

- ▶ Unlocking the luggage compartment with the vehicle key also unlocks the doors.
- ▶ The vehicle must be unlocked before unlocking the luggage compartment with the vehicle key.

Operating requirements

To open the luggage compartment with the vehicle key, the trailer socket must not be occupied.

Selector lever position P must be engaged to open the luggage compartment with the vehicle key.

Opening with the vehicle key must be activated in the settings.

For further information:

For settings, see page 98.

Opening the luggage compartment



Press and hold the button on the vehicle key for approximately 1 second.

Closing the luggage compartment



Depending on vehicle equipment: Press and hold the button on the vehicle key until the luggage compartment is closed.

Releasing the button stops the movement.

If the doors were not unlocked, the luggage compartment is locked again as soon as it closes.

On the luggage compartment

General

With Comfort Access, the luggage compartment can be accessed without activating the vehicle key.

The key is automatically detected near the vehicle.

Depending on the national-market version, compatible smartphones with a digital key are also detected automatically. In this case, the luggage compartment can be opened with a smartphone.

For further information:

BMW Digital Key, see page 94.

Functional prerequisites

- ▶ Carry the vehicle key with you, for example, in your trouser pocket.
- ▶ Bluetooth must be activated on the smartphone to detect the digital key.

Opening the luggage compartment

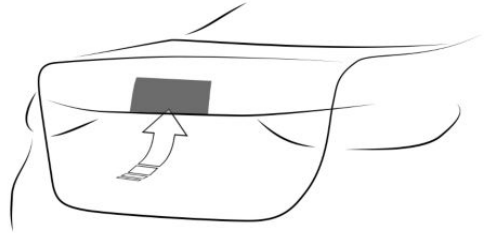

- ▶ Unlock the vehicle and then press the button on the luggage compartment.
- ▶ With Comfort Access: carry the vehicle key with you and press the button on the luggage compartment.
Locked doors are not unlocked.

Closing the luggage compartment manually

Pull the luggage compartment down using the recessed handles.





Depending on vehicle equipment: Press the button on the luggage compartment.

The vehicle is locked after the luggage compartment has been closed. For this to happen,

the driver's door must be closed and the vehicle key must be outside the vehicle in the vicinity of the luggage compartment.

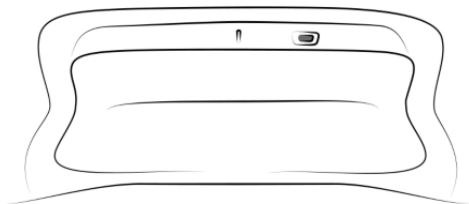
Closing the luggage compartment automatically



- ▶  Press the button on the luggage compartment.
- ▶  Press the button on the luggage compartment.
The vehicle is locked after the luggage compartment has been closed. For this to happen, the driver's door must be closed and the vehicle key must be outside the vehicle in the vicinity of the luggage compartment.
- ▶ Pull the boot lid down slightly. The boot lid is closed automatically.

In the interior

Functional prerequisites

In order to be able to open the luggage compartment with the button in the vehicle interior, the trailer socket must not be occupied.

In order to be able to close the luggage compartment with the button in the interior, the vehicle key or the digital key must be located in the interior.

Opening the luggage compartment



Press the button in the driver's door.

Closing the luggage compartment

Depending on the equipment:



Pull and hold the button in the driver's door.

Cancelling the opening procedure

The opening procedure is interrupted in the following situations:

- ▶ If the vehicle begins to move.
- ▶ By pressing the button on the outside of the luggage compartment. Pressing it again closes the luggage compartment again.
- ▶ By pressing the button on the inside of the luggage compartment. Pressing it again closes the luggage compartment again.
- ▶ By pressing the button on the vehicle key.
Pressing the button again continues the opening process.
Pressing and holding the button again closes the luggage compartment again.
- ▶ By pressing or pulling the button in the driver's door. Pressing again resumes the opening procedure.

Cancelling the closing operation

The closing operation is interrupted in the following situations:

- ▶ When driving off suddenly.
- ▶ By pressing the button on the outside of the luggage compartment. Pressing it again opens the luggage compartment again.
- ▶ By pressing the button on the inside of the luggage compartment. Pressing it again opens the luggage compartment again.
- ▶ By releasing the button on the vehicle key.

Pressing the button again opens the luggage compartment again.

Pressing and holding it again resumes the closing operation.

- ▶ By releasing the button in the driver's door. Pulling and holding the button again resumes the closing operation.

Opening and closing the luggage compartment contactlessly

Principle

Contactless opening of the luggage compartment is possible when carrying the vehicle key on your person. If automatic tailgate operation is installed, the luggage compartment can also be closed contactlessly.

The sensors detect when a foot moves forward or to the side in the central rear area, and the luggage compartment is opened or closed.

General

The availability of the function depends on the equipment and national-market version.

If the vehicle key is within the sensor range, the luggage compartment may open or close inadvertently if you unintentionally move your foot or if a foot movement is detected.

The sensor range extends to approximately 1.50 m, 5 ft behind the rear area.

If you open the luggage compartment contactlessly, locked doors will not be unlocked.

Depending on national-market version, a compatible smartphone with digital key can also be used to contactlessly open and close the luggage compartment.

For further information:

BMW Digital Key, see page 94.

Safety information

WARNING

When opening/closing contactlessly, there is a risk of touching vehicle parts, for example the hot exhaust system. There is a danger of injury. Make sure you are standing securely as you move your foot, and do not touch the vehicle.

WARNING

Parts of the body can become trapped when the boot lid is operated. There is a danger of injury. When opening and closing, make sure that the movement range of the boot lid is kept clear.

WARNING

The boot lid swings rearwards and upwards when opened. There is a danger of injury or material damage. When opening and closing, make sure that the movement range of the boot lid is kept clear.

Operating requirements

- ▶ The vehicle must be equipped with the automatic tailgate in order to close the luggage compartment contactlessly.
- ▶ The trailer socket must be unoccupied in order to open and close the luggage compartment contactlessly.
- ▶ The electric trailer tow hitch must not be extended in order to open and close the luggage compartment contactlessly.
- ▶ Selector lever position P must be engaged in order to open or close the luggage compartment contactlessly.

- ▶ Contactless opening and closing of the luggage compartment must be activated in the settings.
- ▶ Bluetooth must be activated on the smartphone to enable the touchless opening and closing of the luggage compartment using the digital key.

For further information:

For settings, see page 98.

Opening the luggage compartment

1. Stand in the centre behind the vehicle, approximately an arm's length away from the rear of the vehicle.
2. Move one foot under the vehicle in the direction of travel and pull it back immediately, or swipe one foot under the vehicle in one direction. The leg must move across the sensor's range for these movements.

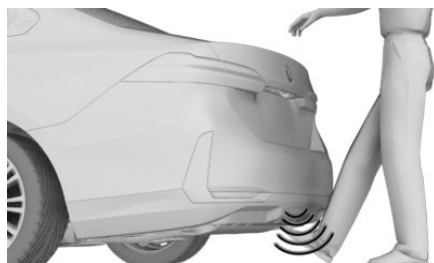

Moving the foot again will stop the opening procedure. The subsequent foot movement will close the luggage compartment again.

Closing the luggage compartment

Perform the foot movement for opening the luggage compartment.

The hazard warning lights flash and an acoustic signal sounds.

Moving the foot again will stop the closing operation. The subsequent foot movement will open the luggage compartment again.

System limits

Detection of foot movement may be restricted by the following external circumstances:

- ▶ Ice, snow or slush on the rear of the vehicle.
- ▶ Dirt or road salt on the rear of the vehicle.

Movement in the vicinity of the sensors may cause the luggage compartment to open or close unintentionally, for example by quickly picking up objects in the rear area. To prevent the luggage compartment from opening unintentionally, make sure that the vehicle key is far enough away from the rear of the vehicle.

Luggage compartment emergency release

The availability of the luggage compartment emergency release depends on the vehicle equipment.



Pull the handle in the luggage compartment. The luggage compartment is unlocked.

Malfunction

In the event of an electrical fault, operate the unlocked boot lid manually; do so slowly and without sudden movements.

Key Card

Principle

The Key Card can be used to lock, unlock and start the vehicle.

General

The availability of the Key Card depends on the equipment and national-market version.

A digital key that has already been paired with the vehicle is installed on the Key Card. The digital key must be activated via iDrive.

When you exit the vehicle, deactivate the Key Card or take the Key Card with you, as it can be used to start the vehicle when activated. Always take the vehicle key with you to a service appointment.

Safety information

NOTICE

If the Key Card and a mobile device are in the wireless charging tray at the same time, the Key Card may be damaged. There is a risk of material damage. Do not place the Key Card in the wireless charging tray at the same time as a mobile device.

Activating/deactivating the Key Card in the vehicle

General

If BMW Digital Key is enabled for the vehicle, a digital key can be used instead of the vehicle key.

A deactivated Key Card will remain in the list of registered digital keys.

Operating requirements

To activate and deactivate the Key Card, there must be a vehicle key in the vehicle.

Activating the Key Card

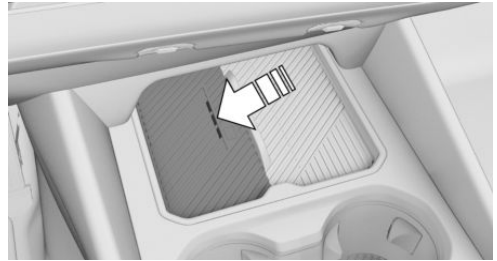

1. Place the Key Card in the middle of the smartphone tray.
2. Follow instructions on the control display.

Deactivating the Key Card

1.  Apps menu
2. "Vehicle"
3. "Doors and windows"
4. "Digital Key"
5. "Key Card"
6. "Deactivate Key Card"

A deactivated Key Card will remain in the list of registered digital keys.

Unlocking and locking the vehicle

The vehicle can be unlocked and locked with the activated Key Card.

For further information:

Access to the vehicle interior, see page [84](#).

Switching on drive-ready state

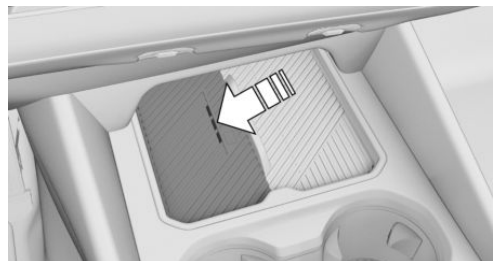

1. Place the activated Key Card in the middle of the smartphone tray.
 2. Press the Start/Stop button.
- After turning on the drive-ready state, the Key Card can be taken out of the storage tray.

Malfunction

Objects between the sensors and the Key Card, for example a purse/wallet or smartphone case, may prevent the vehicle from detecting the Key Card.

BMW Digital Key

Principle

BMW Digital Key allows you to use a compatible smartphone to lock, unlock and start the vehicle.

General

The availability and scope of functions of BMW Digital Key depend on the equipment and national-market version.

BMW Digital Key can be used with a compatible smartphone or other compatible end devices.

To unlock and start a vehicle with a compatible smartphone, this function must be offered by the smartphone manufacturer. It is possible to check in the My BMW App whether the smartphone and the vehicle are compatible and which functions are supported.

A BMW ID or a driver profile with individual settings can be assigned to a digital key.

When using a smartphone as a digital key, it is helpful to carry the deactivated Key Card in the vehicle. In situations where the vehicle has to be handed over to another person, the Key Card can be handed over instead of the smartphone. For this, the Key Card must be activated via iDrive.

Always take the vehicle key with you to a service appointment.

For further information:

- ▷ BMW ID/driver profiles, see page 75.
- ▷ Key Card, see page 92.
- ▷ www.bmw.com/digitalkey

Operating requirements

- ▷ The smartphone is compatible with BMW Digital Key.
- ▷ The vehicle is linked with the Connected-Drive account of the registered keeper.
- ▷ The smartphone battery is sufficiently charged. The minimum battery charge required depends on the smartphone in question.

Enabling the main digital key

The registered keeper's smartphone is enabled as the main digital key in the vehicle. To do so, the registered keeper must provide proof of authorisation for their vehicle.

Proof of authorisation can be started via the My BMW App or via the activation code in the corresponding smartphone function, for example, in the Wallet app. Both vehicle keys must be in the vehicle during activation.

Follow the activation instructions in the Digital Key menu in the app or on the control display.

Sharing digital keys

General

Digital Key enables digital keys to be shared with other people. This option is provided via the smartphone enabled as the main digital key. This function must be supported by the smartphone.

Passing on authorisation

To share the digital key, select the corresponding function on the smartphone, for example in the Wallet app.

As soon as a digital key is shared with a person, this person receives an invitation. If the invitation is accepted, the digital key is activated on the recipient's smartphone.

Limiting the range of functions

Certain functions of the digital key can be limited before handing it over. For example, restrictions on driving stability control systems can be suppressed and engine performance can be reduced before the digital key is given to a beginner driver. Further information can be found on the ConnectedDrive portal and in the My BMW App.

Authentication

Depending on the recipient's smartphone model, authentication may be required for security reasons.

An authorised vehicle key, the main digital key or another method can be used to perform the authentication. Corresponding information is displayed for your attention on the smartphone or control display.

Deleting digital keys

General

Deleted digital keys are removed from the list of enabled digital keys.

Deleted digital keys cannot be restored.

Deleting the digital master key

The digital master key can be deleted from the smartphone or via iDrive.

The deletion of the digital master key is completed immediately.

Deleting a shared key

Shared keys can be deleted via the smartphone associated with the digital main key, via the smartphone associated with the key to be deleted or via iDrive.

A shared key will only be deleted via the smartphone associated with the main digital key if the vehicle is being used with a key other than the one that is to be deleted.

Deletion via the smartphone associated with the key to be deleted or via iDrive will take place immediately.

Deletion in iDrive

To enable a digital key to be deleted via iDrive, there must be an authorised vehicle key in the vehicle or the digital main key must be in the smartphone tray.

1.  Apps menu
2. "Vehicle"
3. "Doors and windows"
4. "Digital Key"
5. Select a digital key as necessary.
6. Delete the Digital Key.

Resetting the function

To reset BMW Digital Key function, there must be an authorised vehicle key in the vehicle.

All digital keys, including the main key, are deleted when the BMW Digital Key function is reset. The digital key of the Key Card is not deleted.

Following the reset, it will no longer be possible to lock, unlock or start the vehicle with a digital key.

The main digital key must be enabled again in order to be able to use BMW Digital Key again.

1.  Apps menu
2. "Vehicle"
3. "Doors and windows"

4. "Digital Key"
5. "Reset function"

Unlocking and locking the vehicle

The vehicle can be unlocked and locked as follows:

- ▷ Via the outside door handle.
- ▷ With Comfort Access: depending on the national-market version, the vehicle can be locked and unlocked with no-touch activation.

Bluetooth must be enabled on the smartphone for contactless unlocking and locking with the digital key.

The availability and scope of functions of BMW Digital Key depend on the equipment and national-market version.

For further information:

Access to the vehicle interior, see page 84.

Switching on drive-ready state

Using the smartphone tray

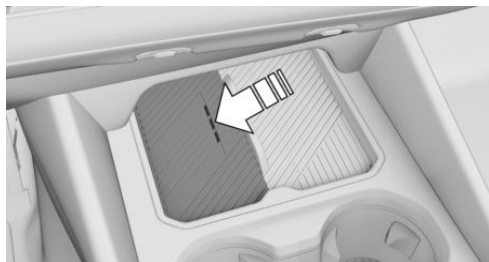

1. Place the smartphone in the middle of the smartphone tray.
Make sure that the display is pointing upwards.
2. Press the Start/Stop button to turn on the drive-ready state.

In the interior

With Comfort Access, it is sufficient, depending on the national-market version, for the smart-

phone with activated Bluetooth to be located in the interior. Press the Start/Stop button to turn on the drive-ready state.

Selling the smartphone

Delete all digital keys from the smartphone before selling it. This ensures that the smartphone can no longer be used for the vehicle.

Changing smartphones

In order to be able to use a new smartphone as a digital main key, the new smartphone must be activated in accordance with the description for the digital main key. The previous main key is deleted when the new smartphone is activated.

Selling the vehicle

Before selling a vehicle, reset the digital key function or remove the vehicle from the ConnectedDrive account of the current registered keeper.

If the vehicle is removed from the ConnectedDrive account, all digital keys for the vehicle are deleted. The digital key of the Key Card is not deleted.

System limits

With a digital key, it is not possible to switch off the interior movement sensor and the tilt alarm sensor of the alarm system.

For further information:

Alarm system, see page 100.

Malfunction

It may be difficult for the vehicle to detect the digital key in some circumstances, including the following:

- ▶ The smartphone is shielded from the sensors in the vehicle by an unsuitable smartphone cover.
- ▶ There are objects between the smartphone and its cover, for example a card with a chip or the Key Card.
- ▶ Fault of the connection from transmission towers or other equipment with high transmitting power.
- ▶ Shielding of the smartphone due to buildings or metal objects.

Central locking buttons

General

The vehicle is automatically locked when moving off.

If an accident of appropriate severity occurs, the vehicle is automatically unlocked. The hazard warning lights and the interior lights illuminate.

Overview

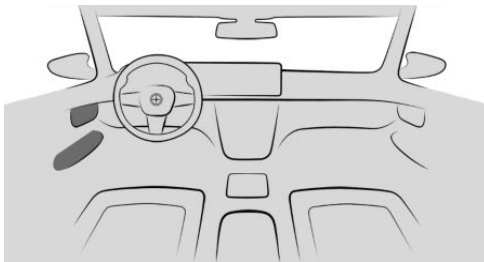

The central locking system buttons are located on the front door.

Locking the vehicle



With the front doors closed, press the button on the driver's door or front passenger door.

The fuel filler flap remains unlocked.

Locking does not activate the vehicle's anti-theft protection system.

Unlocking the vehicle



Press the key.

To open the door



- ▶ Press the button to unlock all the doors together.
Pull the door handle above the armrest.
- ▶ Pull the door handle on the door being opened. The other doors remain locked.

Soft-close function for doors

Principle

The soft-close function reduces the effort and noise when closing doors.

The door can be pushed into the door lock without effort, and the door automatically closes completely.

Safety information

WARNING

Parts of the body can become trapped when the doors are operated. There is a danger of injury. When opening and closing, make sure that the movement range of the doors is kept clear.

Closing

To close, press the door gently.

The closing process is automatic.

Valet parking mode

Principle

The control display is disabled in valet parking mode.

This mode can be used, for example, if the vehicle is to be handed over to a parking service.

General

Depending on the national-market version, the valet parking mode may not be available.

Valet parking mode includes the following restrictions:

- ▶ Changes to the vehicle settings via iDrive are not possible.
- ▶ Settings stored in a BMW ID or a guest profile cannot be changed.
- ▶ Personal data cannot be displayed.
- ▶ The volume of the audio system is limited.
- ▶ The Dynamic Stability Control cannot be deactivated.
- ▶ The availability of certain settings of the drive modes is restricted.

For further information:

BMW ID/driver profiles, see page 75.

Operating requirements

The driver has registered in the vehicle with a BMW ID.

Activating valet parking mode

1.  Apps menu
2. "Vehicle"
3. "System settings"
4. "Valet parking mode"
5. "Lock tailgate"

The luggage compartment is locked and disconnected from the central locking system.

6. If necessary, "PIN"

If the active BMW ID does not have an assigned PIN, create a PIN. The PIN is needed to deactivate the valet parking mode.

7. If necessary, enter the PIN.
8. "Activate valet parking mode"

Deactivating valet parking mode

1. Select the desired BMW ID on the lock screen.
2. ▶ Enter the assigned PIN for the BMW ID.
If the PIN was forgotten: enter access data for the BMW ID.
- ▶ If the selected BMW ID does not have an assigned PIN: enter access data for the BMW ID.

Settings

General

Depending on vehicle equipment and national-market version, various settings are possible for opening and closing.

Unlocking and locking

Doors

1.  Apps menu
2. "Vehicle"
3. "Doors and windows"
4. "Lock/unlock"
5. "Unlock"
6. Select the desired setting:
 - ▶ "Driver's door only"
Only the driver's door and fuel filler flap are unlocked. Pressing again unlocks the entire vehicle.
 - ▶ "All doors"
The entire vehicle is unlocked.

Touchless unlocking/locking

1.  Apps menu
2. "Vehicle"
3. "Doors and windows"
4. "Comfort access"
5. Select the desired setting.

Automatic unlocking

1.  Apps menu
2. "Vehicle"
3. "Doors and windows"
4. "Lock/unlock"
5. Select the desired setting:
 - ▷ "Unlock doors at end of trip"
 - ▷ "Unlock doors when in P"

After drive-ready state has been switched off by pressing the Start/Stop button or by engaging the selector lever position P, the locked vehicle is automatically unlocked.

Automatic locking

1.  Apps menu
2. "Vehicle"
3. "Doors and windows"
4. "Lock/unlock"
5. "Lock after a short time"

The vehicle is automatically locked again after a short while if no doors are opened after unlocking.

Vehicle acknowledgement signals

1.  Apps menu
2. "Vehicle"
3. "Doors and windows"
4. "Lock/unlock"
5. Select the desired setting:
 - ▷ "Flash when unlocking"
Unlocking is confirmed by two flashes.
 - ▷ "Flash when locking"

Locking is confirmed by flashing once.

- ▷ With alarm system:
"Sound on lock/unlock"
Unlocking is acknowledged by two acoustic signals, locking by one acoustic signal.

Automatic folding of the mirrors

1.  Apps menu
2. "Vehicle"
3. "Doors and windows"
4. "Lock/unlock"
5. "Fold mirrors on lock/unlock"

Luggage compartment

Luggage compartment and doors

1.  Apps menu
2. "Vehicle"
3. "Doors and windows"
4. "Tailgate"
5. Select the desired setting:
 - ▷ "Tailgate"
Depending on vehicle equipment, the luggage compartment will be unlocked or opened.
 - ▷ "Tailgate and door(s)"
Depending on the equipment, the luggage compartment will be unlocked or opened and the doors are unlocked.
 - ▷ "Tailgate will only open if vehicle is already unlocked"
The vehicle must be unlocked before the luggage compartment can be operated with the vehicle key.
 - ▷ "Lock tailgate button"
Operation of the luggage compartment with the vehicle key is disabled.



Opening/closing the luggage compartment contactlessly

1. Apps menu
2. "Vehicle"
3. "Doors and windows"
4. "Tailgate"
5. Select the desired setting.

Closing the sun protection automatically

It is possible to set whether the roller sun-blind closes automatically when the vehicle is locked.

1. Apps menu
2. "Vehicle"
3. "Doors and windows"
4. "Close roof blind automatically"
5. Select the desired setting.

Alarm system

Principle

The alarm system visually and acoustically signals when someone attempts to open the locked vehicle.

General

The alarm system responds to the following changes in a locked vehicle:

- ▷ Opening a door, the bonnet or the luggage compartment.
- ▷ Movements inside the vehicle interior.
- ▷ A change in the vehicle's angle of inclination, for instance if an attempt is made to jack it up and steal the wheels or to raise it prior to towing away.
- ▷ An interruption in the battery voltage.

- ▷ Improper use of the diagnostic socket.
- ▷ Locking the vehicle while a device is connected to the on-board diagnostic socket.

The alarm system indicates these changes visually and audibly:

- ▷ Acoustic alarm:
Depending on local regulations, the acoustic alarm may be suppressed.
- ▷ Optical alarm:
By flashing of the hazard warning lights and, if applicable, the headlights.

To safeguard operation of the alarm system, do not modify the system.

Turning the alarm system on/off

The alarm system switches on as soon as the vehicle is locked from the outside.

The alarm system does not switch on if the vehicle is locked remotely from a distance using the My BMW app, or manually from inside the vehicle.

The alarm system is switched off as soon as the vehicle is unlocked.

Opening the doors when the alarm system is switched on

The alarm system is triggered when a door is opened if it has been unlocked via the door lock using the integrated key.

Opening the luggage compartment with the alarm system turned on

The luggage compartment can be opened even when the alarm system is turned on.

After closing the luggage compartment, the luggage compartment will be locked and monitored again. The hazard warning lights flash once during closing.

Indicator light on the interior mirror



- ▶ The indicator light flashes every 2 seconds:
The alarm system is switched on.
- ▶ The indicator light flashes for approximately 10 seconds then switches to flashing every 2 seconds:
The interior movement detector and tilt alarm sensor are not active because the doors, bonnet or tailgate are not closed correctly. Correctly closed access points are secured.
Once the remaining open access points have been closed, the interior movement detector and tilt alarm sensor are switched on.
- ▶ The indicator light flashes even though all accesses have been closed:
Error in the alarm system.
- ▶ The indicator light extinguishes after the vehicle has been unlocked:
This means that the vehicle is not being tampered with.
- ▶ The indicator light flashes after unlocking until drive-ready state is switched on, but for no longer than approximately 5 minutes:
The alarm has been triggered.

Tilt alarm sensor

The vehicle's angle of inclination is monitored. The alarm system responds, for example when there is an attempt to steal a wheel or tow the vehicle away.

Interior movement detector

The vehicle interior is monitored.

The alarm system responds when movement is detected in the vehicle interior.

To ensure perfect functioning, the windows must be closed.

Avoiding false warnings

General

The tilt alarm sensor and the interior movement detector may trigger an alarm even though no unauthorised activity is taking place.

Situations where false warnings may occur:

- ▶ In washing bays or car washes.
- ▶ In two-level garages.
- ▶ When transporting the vehicle via motorail, car ferry or trailer.
- ▶ When there are pets in the vehicle.
- ▶ When the vehicle is locked after starting to refuel.

The tilt alarm sensor and interior movement detector can be switched off for such situations.

Switching off the tilt alarm sensor and interior movement detector

- ▶  Within 30 seconds of locking the vehicle, press the button on the vehicle key.
The indicator light illuminates for approximately 2 seconds and then flashes again.
- ▶ After turning off the standby state, an option to turn off the interior movement detector and the tilt alarm sensor will be displayed on the control display.

The tilt alarm sensor and the interior movement detector are switched off until the next time the vehicle is locked.

Ending the alarm

Unlock the vehicle.

If the vehicle is unlocked with the integrated key, drive-ready state must then be turned on via emergency detection of the vehicle key.

Window

General

If a window is often opened in the same location, this task can be carried out by the BMW Intelligent Personal Assistant. Useful, for example, if the same multi-storey car park is frequently used.

For further information:

BMW Intelligent Personal Assistant, see page [60](#).

Safety information

WARNING

Parts of the body can become trapped when the windows are operated. There is a danger of injury or material damage. When opening and closing, make sure that the movement range of the windows is kept clear.

With the vehicle key

Opening windows



Keep the button on the vehicle key pressed after unlocking.

The windows open for as long as the button on the vehicle key remains pressed.

Close windows



Keep the button on the vehicle key pressed after locking.

The windows close for as long as the button on the vehicle key remains pressed.

Depending on the equipment, the exterior mirrors are folded in provided that they were not folded in when the vehicle was locked. If the hazard warning lights are switched on, the exterior mirrors are not folded in.

On the outside door handle

Principle

The windows can be closed via the outside door handle without operating the vehicle key. The vehicle key is automatically detected near the vehicle.

General

The function is available with Comfort Access. Depending on the national-market version, the windows can also be closed at the outside door handle with compatible smartphones with digital key.

For further information:

BMW Digital Key, see page [94](#).

Functional prerequisites

- ▶ Carry the vehicle key with you, for example, in your trouser pocket.
- ▶ Bluetooth must be activated on the smartphone to close the windows with the digital key.

Close windows

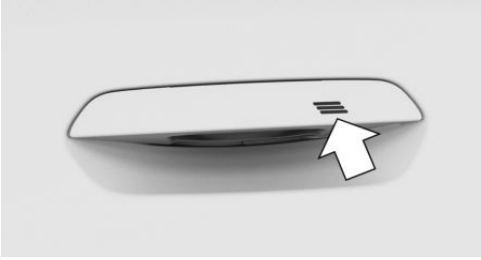

Touch the grooved surface on the outside door handle of a closed front door with your finger and hold it there without grasping the handle recess.

The windows are also closed for locking.

Depending on the equipment, the exterior mirrors are folded in provided that they were not folded in when the vehicle was locked. If the hazard warning lights are switched on, the exterior mirrors are not folded in.

In the interior

Overview

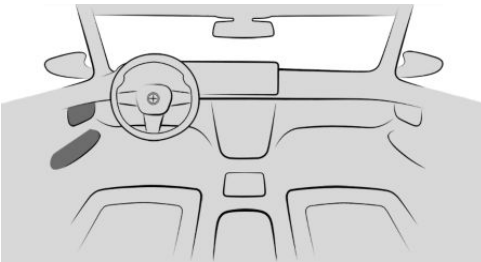



Window lifters

Operating requirements



- ▶ Standby state is switched on.
- ▶ Drive-ready state is switched on.
- ▶ For a short while after rest state has been established.

The vehicle key or a digital key must be inside of the vehicle.

Opening windows

- ▶  Press the switch as far as the resistance point.
The window opens for as long as the switch is held.
- ▶  Press the switch past the resistance point.
The window is opened automatically. Pressing the switch again stops the movement.

Close windows

- ▶  Pull the switch as far as the resistance point.
The window closes for as long as the switch is held.
- ▶  Pull the switch past the resistance point.
The window closes automatically. Pulling the switch again stops the movement.

Anti-trap mechanism

Principle

The anti-trap mechanism prevents objects or parts of the body from becoming trapped between the door frame and window while a window is being closed.

General

If resistance or an obstruction is detected while a window is being closed, the closing process is interrupted.



Safety information

WARNING

Accessories on the windows, for example aerials, can impair the anti-trap mechanism. There is a danger of injury. Do not attach any accessories within the movement range of the windows.

Closing with no anti-trap mechanism

If an external hazard or ice prevents normal closure, proceed as follows:

-  Pull the switch past the resistance point and hold it in this position.
The window is closed but with restricted anti-trap mechanism. If the closing force exceeds a certain level, the closing operation is interrupted.
-  Pull the switch past the resistance point again within approximately 4 seconds and hold it in this position.
The window is closed with no anti-trap mechanism.

Window roller sunblinds

Safety information

WARNING

When the roller sunblinds are closed and the windows opened, the roller sunblinds can be heavily stressed during the journey due to the air stream. The roller sunblinds can become damaged and endanger vehicle occupants. There is a danger of injury. Do not open the windows during the journey when the roller sunblinds are closed.

Overview

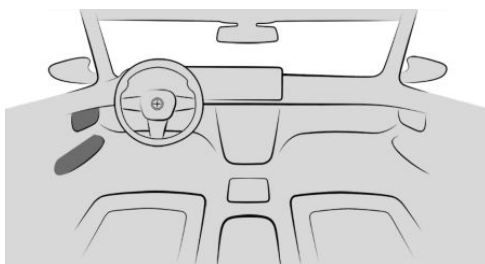

Button for the rear window roller blind.

Operating the side roller blinds

Pull the side roller sunblind out with the loop and hook into the holder.

Operating the rear roller blind

On the driver's door



Press the button on the driver's door to open the closed rear roller blind or to close the opened rear roller blind.

Pressing the button on the driver's door again during the movement moves the rear roller blind in the opposite direction.

System limits

If the rear roller blinds can no longer be moved after a number of operations in immediate succession, the overheating protection mechanism is active. The system is blocked for a limited time to prevent overheating. Allow the system to cool down.

Safety switch

Principle

The safety switch can be used to prevent children from opening and closing the rear win-

dows with the switches in the rear, for example.

If an accident of appropriate severity occurs, the safety function is automatically switched off.

Overview

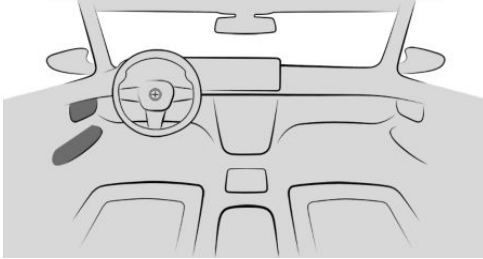

Safety switch

Turning the safety functions on/off



Press the key.

The LED in the button illuminates when the safety function is switched

on.

Seats, mirrors and steering wheel

Vehicle equipment

This chapter describes equipment, systems and functions which are offered or may be offered in future on a model-specific basis, even if they are not included in the vehicle in question.

For further information:

Vehicle equipment, see page 8.

Safe seating position

A seat position that suitably meets the needs of the occupants is essential for relaxed driving with minimum fatigue.

In an accident, the correct seat position plays an important role. Pay attention to the notes in the following chapters.

For further information:

- ▷ Seats, see page 106.
- ▷ Seat belts, see page 110.
- ▷ Head restraints, see page 113.
- ▷ Airbags, see page 184.

Seats

Safety information

⚠ WARNING

Setting the seat during a journey could cause the seat to move unexpectedly. You could lose control of the vehicle. There is a risk of accident. Only adjust the seat on the driver's side when at a standstill.

⚠ WARNING

If the backrest is angled too far back, the protective effect of the seat belt will no longer be guaranteed. There is a risk of sliding under the seat belt in the event of an accident. There is a danger of injury or danger to life. Adjust the seat before starting the journey. Adjust the backrest to the most upright position possible, and do not change it during the journey.

⚠ WARNING

There is a risk of entrapment when the seats are moved. There is a danger of injury or material damage. Before making any adjustment, make sure that the movement range of the seat is clear.

Partly electrically adjustable seats

Overview



The levers and switches for the seat settings are located at the front seats.

Adjusting the forward/back position



Pull the lever and slide the seat in the desired direction.

After releasing the lever, move the seat gently forward or back to make sure it engages properly.

Adjusting the backrest angle

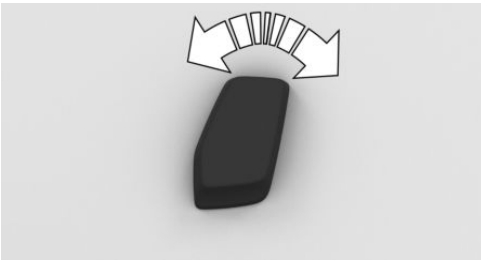

Tilt the switch forwards or backwards.

Adjusting the height

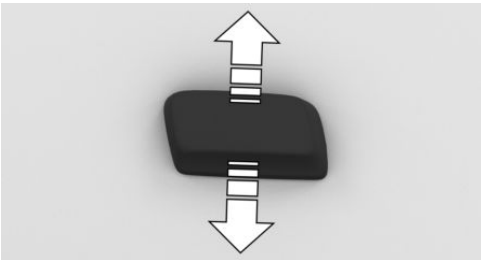

Press the switch up or down.

Adjusting the seat angle

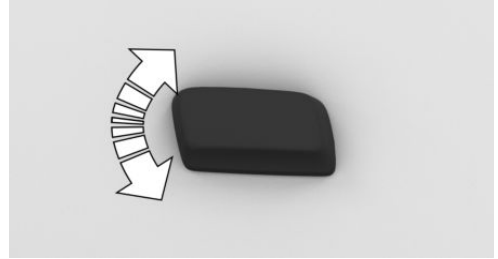

Tilt the switch up or down.

Electrically adjustable seats

General

The current seat position can be saved using the memory function.

Overview

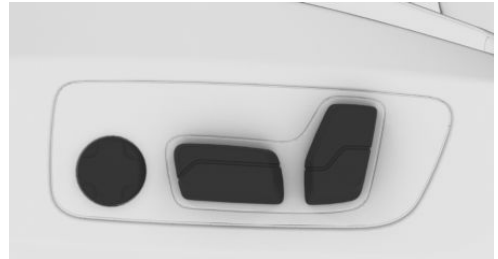

The switches for the seat settings are located at the front seats.

Seat settings menu

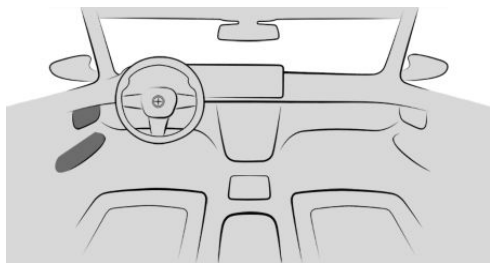

The seat adjustment menu button is located on the front door.



Press the button to open the seat setting menu on the control display.

Adjusting the forward/back position

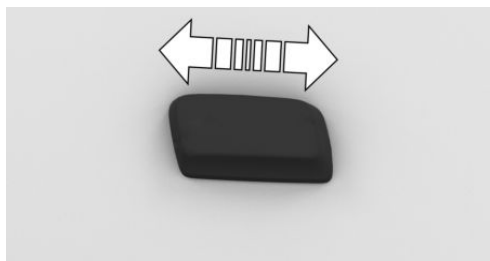

Press the switch forwards or backwards.

Adjusting the height

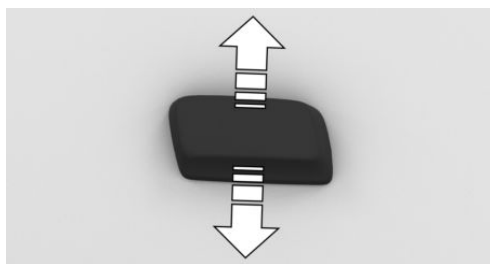

Press the switch up or down.

Adjusting the seat angle

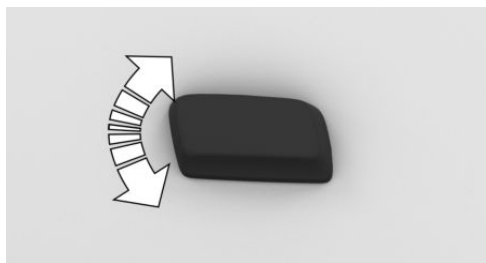

Tilt the switch up or down.

Adjusting the backrest angle

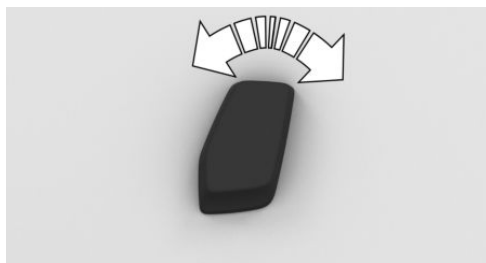

Tilt the switch forwards or backwards.

Adjusting the seat position automatically

General

The seat setting for the driver's seat is stored in the active BMW ID or in the active driver profile. If the BMW ID or the driver profile is reactivated at a later time, the stored position is loaded automatically.

Activating/deactivating the function

1.  Apps menu
2. "Vehicle"
3. "Seat comfort"
4. Select driver's seat.
5. "Use automatically"
6. Select the desired setting.

Thigh support

Sport seat

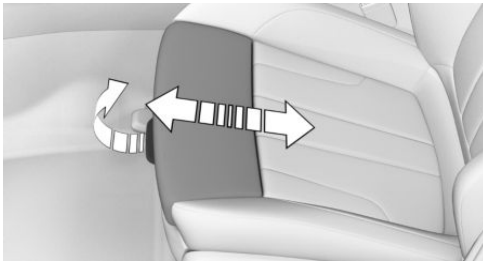

Pull the lever on the front of the seat and adjust the thigh support forwards or backwards.

Multifunction seat

1.  Apps menu
2. "Vehicle"
3. "Seat comfort"
4. Select the desired seat.
5. Select the desired function.
6. Select the desired setting.

Lumbar support

Principle

The curvature of the backrest can be changed to provide support for the lumbar region, or lordosis. The upper edge of the pelvis and the spinal column are supported to encourage an upright sitting posture.

Adjusting the lumbar support



- ▶ Press the button at the front/rear:
The curvature is increased/decreased.
- ▶ Press the button at the top/bottom:
The curvature is shifted upwards/downwards.

Function limitation

It may not be possible to adjust the lumbar support at very high and very low temperatures.

Backrest width

Principle

The backrest width can be adjusted to improve lateral support when cornering.

General

The backrest width is changed by adjusting the side sections of the backrest.

When exiting the vehicle, the backrest width opens completely. Before the start of the journey, the last set position is automatically moved to.

Adjusting the backrest width

1.  Apps menu
2. "Vehicle"
3. "Seat comfort"
4. Select the desired seat.
5. Select the desired function.
6. Select the desired setting.

Calibrating the front seats

General

As soon as the electric seat adjustment no longer functions precisely, a Check Control message is displayed on the control display.

To restore the accuracy of the electric seat setting, the front seats must be calibrated.

Safety information

WARNING

There is a risk of entrapment when the seats are moved. There is a danger of injury or material damage. Before making any adjustment, make sure that the movement range of the seat is clear.

Calibrating the front seat

1. Push the switch forward again in a longitudinal direction until the seat stops.
2. Push and hold the switch forward repeatedly until the seat no longer moves forward.
3. Reset the desired seat position.

As soon as the message on the control display disappears, the calibration is complete. If the message remains active, repeat the calibration.

If the message is not hidden after repeated calibration, have the system checked by an authorised Service Partner or another qualified Service Partner or a specialist workshop.

Seat belts

General

For the safety of the vehicle occupants, the vehicle is equipped with five seat belts. However, they can only provide a protective effect when applied correctly.

Before each journey, always make sure that all occupants have fastened their seat belts. The airbags supplement the seat belts as an additional safety device. The airbags are not a substitute for the seat belts.

All belt anchorages are designed to achieve the best possible protective effect of the seat belts with proper use of the seat belts and correct seat setting.

The two outer seat belt buckles on the rear seats are intended for those sitting on the left and right.

The inner seat belt buckle on the rear seats is intended for the person sitting in the middle.

For further information:

Notes on sitting safely, see page [106](#).

Safety information

WARNING

If a seat belt is used by more than one person at the same time, the protective effect of the seat belt is no longer guaranteed. There is a danger of injury or danger to life. Only one person should use each seat belt at any one time. Do not allow infants and children to travel on the lap of another occupant. Instead, secure the infant or child in child restraint systems intended for this purpose.

WARNING

The protective effect of the seat belts may be restricted or may even fail completely if the seat belts are worn incorrectly. If a seat belt is not worn correctly, additional injuries can be caused, for example in the event of an accident, braking or avoidance manoeuvre. There is a danger of injury or danger to life. Make sure that all vehicle occupants have fastened their seat belts correctly.

WARNING

Seat belts are designed to bear upon the bony structure of the body and should be worn low across the front of the pelvis, or the pelvis, chest and shoulders, as applicable. Wearing the lap section of the belt across the abdominal area must be avoided.

Seat belts should be adjusted as firmly as possible, consistent with comfort, to provide the protection for which they have been designed. A slack seat belt will greatly reduce the protection afforded to the wearer.

Care should be taken to avoid contamination of the seat belt strap by polishes, oils and chemicals and particularly battery acid. Cleaning may safely be carried out using a mild soap and water solution. The seat belt should be replaced if the seat belt strap becomes frayed, contaminated or damaged. Seat belts should not be worn with straps twisted. Each seat belt assembly must only be used by one occupant; it is forbidden to put a belt around a child being carried on the occupant's lap.

It is essential to replace the entire seat belt assembly after it has been worn in a severe impact even if damage to the assembly is not obvious.

WARNING

No modifications or additions should be made by the user that will either prevent the seat belt adjusting devices from operating to remove slack, or prevent the seat belt assembly from being adjusted to remove slack.

WARNING

If the rear seat backrest is not locked, the protective effect of the middle seat belt is not ensured. There is a danger of injury or danger to life. Lock the wider rear seat backrest when using the middle seat belt.

WARNING

The protective effect of the seat belts may be restricted or may even fail completely in the following situations:

- ▷ If the seat belts or seat belt buckles are damaged, dirty or have been modified in another way.
- ▷ The seat belt tensioners or belt retractors have been modified.

Seat belts can be damaged in an accident without the damage necessarily being apparent. There is a danger of injury or danger to life. Do not modify the seat belts, seat belt buckles, seat belt tensioners, belt retractors, or belt anchor points, and ensure that they are kept clean. After an accident, have the seat belts inspected at an authorised Service Partner or another qualified Service Partner or a specialist workshop.

Correct seat belt use

- ▷ Place the seat belt tightly over the pelvis and shoulder, close to the body and without twisting.
- ▷ Make sure that the seat belt is positioned low at the hips in the area of the pelvis. The seat belt must not press on the abdomen.
- ▷ The seat belt must not be allowed to rub against sharp edges, be routed over solid or breakable objects or be trapped.
- ▷ Avoid wearing bulky clothing.
- ▷ Keep the seat belt taut by occasionally pulling upwards on the upper body area.

Setting for automatic retracting seat belts

- ▷ Draw the seat belt tongue attached to the seat belt across the body and press it into the seat belt buckle until a 'click' is heard.
- ▷ Adjustment of the belt length is very important. To adjust the lap belt and check whether the seat belt buckle has locked correctly, pull upwards on the shoulder strap until the lap belt fits tightly.

- ▶ The length of the diagonal shoulder strap adjusts itself automatically to allow freedom of movement.
- ▶ To release the seat belt, press the button on the seat belt buckle.

Fastening the seat belt

1. When fastening the seat belt, guide it slowly over the shoulder and pelvis.
2. Insert the seat belt tongue in the seat belt buckle. The seat belt buckle must be heard to engage.

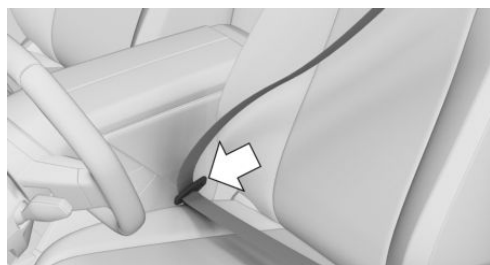

Unfastening the seat belt

1. Hold the seat belt firmly.
2. Press the red button on the seat belt buckle.
3. Guide the seat belt back up to the automatic reel.

Middle seat belt in the rear

Fastening the seat belt

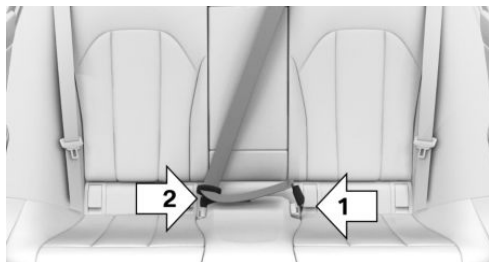

1. Pull the seat belt tongues from the mount on the parcel shelf.
2. Insert the lower seat belt tongue in the belt lock, arrow 1.
3. Insert the upper seat belt tongue in the seat belt buckle, arrow 2.
The seat belt buckles must be heard to engage.

Unfastening the seat belt

1. Hold the seat belt firmly.
2. Press the red button on the seat belt buckle.
3. Use the seat belt tongue, arrow 1, to open the belt lock, arrow 2.

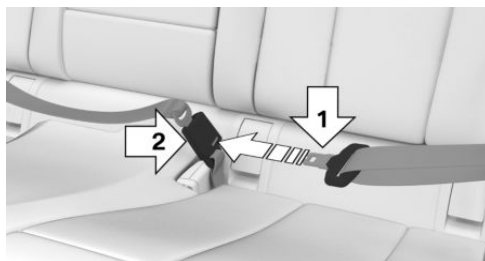

4. Guide the seat belt to the bracket on the parcel shelf.

Seat belt warning

General

Check whether the seat belts are fastened correctly.

The seat belt warning becomes active in the following situations:

- ▶ When the seat belt on the driver's side or on the passenger's side is not fastened.
- ▶ In some national-market versions, the seat belt warning is also active if the seat belt on a seat of the second row of seats is not fastened.





- ▷ When the seat belt is unfastened while driving.
- ▷ When objects are lying on a seat.

Display in the instrument cluster

The indicator light in the instrument cluster illuminates after turning on the drive-ready state and the seat belt warning is active.

A Check Control message is shown where applicable. Check whether the seat belt has been fastened correctly.

The displays may vary depending on the equipment and national-market version.

Icon	Meaning
	Seat belt is not buckled.
	Seat belt is only buckled on the corresponding seat.
	Seat belt on the corresponding seat is not buckled.
	Depending on the national-market version: Corresponding seat is not occupied.
	Depending on the national-market version: The seat belt warning is deactivated for the corresponding seat.

Enabling/disabling the seat belt warning

Depending on the national-market version: the seat belt warning can be deactivated for transporting objects on a second row of seats.

If a seat belt is unbuckled while driving, a warning will continue to be issued.

1.  Apps menu
2. "Vehicle"
3. "Seat comfort"
4. "Seatbelt warning"
5. Select the desired setting.

Safety function

Depending on the equipment, the driver's and front passenger's seat belt straps are automatically tightened once after driving off, if the seat belt is fastened.

If necessary, the front seat belts are automatically pretensioned in accident-critical driving situations, for example, in the event of full braking.

If the critical driving situation passes without an accident occurring, the tension in the front seat belts is slackened again. If the belt tension does not slacken automatically, stop the vehicle and unfasten the seat belt by pressing the red button on the seat belt buckle. Fasten the seat belt again before continuing driving.

Front head restraints

Safety information

WARNING

If the head restraints are removed or incorrectly adjusted, they cannot provide protective effect as intended and head and neck injuries may result. There is a danger of injury.

- ▷ Before a journey, re-install any removed head restraints on all occupied seats.
- ▷ Adjust the head restraint so that its centre supports the back of the head at eye level where possible.
- ▷ Adjust the distance so that the head restraint is as close as possible to the back of the head. If necessary, adjust the distance by adjusting the backrest angle.

WARNING

Parts of the body can become trapped when the head restraint is moved. There is a danger of injury. When moving the head restraint, make sure that the movement range is kept clear.

WARNING

Objects on the head restraint impair the protective effect of the head restraint in the head and neck area. There is a danger of injury.

- ▷ Do not fit any covers on the seats or head restraints.
- ▷ Do not hang objects such as coat hangers directly on the head restraint.
- ▷ Only use accessories that have been classified as safe for attaching to the head restraint.
- ▷ Do not use any accessories, for example cushions, during the journey.

Adjusting the height: manual head restraints



Press the button and slide the head restraint up or down.

After adjusting the height, make sure that the head restraint engages correctly.

Adjusting the height: electric head restraints

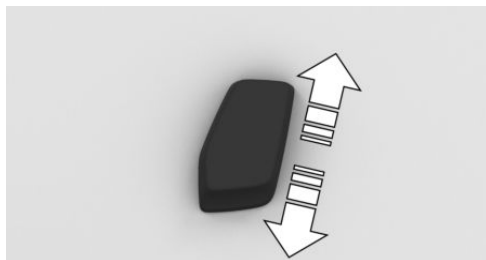

Press the switch up or down.

Adjusting the distance

Adjust the distance so that the head restraint is as close as possible to the back of the head.



Press the button and push the head restraint forwards or backwards.

After adjusting the distance, make sure that the head restraint engages correctly.

Removing the head restraints

The head restraints cannot be removed.

Rear head restraints

Safety information

WARNING

If the head restraints are removed or incorrectly adjusted, they cannot provide protective effect as intended and head and neck injuries may result. There is a danger of injury.

- ▷ Before a journey, re-install any removed head restraints on all occupied seats.
- ▷ Adjust the head restraint so that its centre supports the back of the head at eye level where possible.
- ▷ Adjust the distance so that the head restraint is as close as possible to the back of the head. If necessary, adjust the distance by adjusting the backrest angle.

WARNING

Parts of the body can become trapped when the head restraint is moved. There is a danger of injury. When moving the head restraint, make sure that the movement range is kept clear.

WARNING

Objects on the head restraint impair the protective effect of the head restraint in the head and neck area. There is a danger of injury.

- ▷ Do not fit any covers on the seats or head restraints.
- ▷ Do not hang objects such as coat hangers directly on the head restraint.
- ▷ Only use accessories that have been classified as safe for attaching to the head restraint.
- ▷ Do not use any accessories, for example cushions, during the journey.

Outer head restraints adjusting the height



- ▷ Down: press the button, arrow 1, and slide the head restraint downwards.
- ▷ Up: push the head restraint upwards.

After adjusting the height, make sure that the head restraint engages correctly.

Adjusting the height of the centre head restraint

The middle head restraint can be folded down to improve rearward visibility. Only set it to the lowest position if no one is sitting on the middle seat.

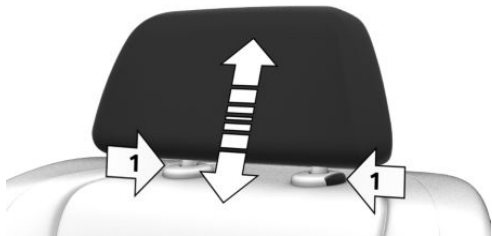

- ▷ Down: press the buttons, arrows 1, and slide the head restraint downwards.
- ▷ Up: push the head restraint upwards.

After adjusting the height, make sure that the head restraint engages correctly.

Removing the outer head restraints

Only remove the head restraint if no-one is intending to sit in the seat in question.

1. Fold down the respective rear seat backrest.
To enlarge the luggage compartment, see page 320.
2. Push the head restraint up until resistance is felt.
3. Insert the integrated key.

Integrated key, see page 80.

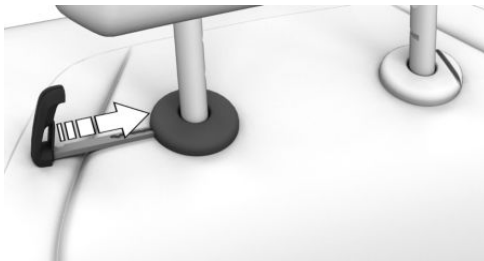

4. Press and hold the integrated key and the button simultaneously, arrows 1, and pull the head restraint fully out.

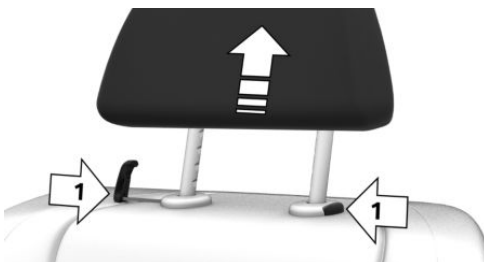

Removing the middle head restraint

Only remove the head restraint if no one is sitting on the middle seat.

1. Push the head restraint up until resistance is felt.
2. Press the buttons, arrows 1, and pull the head restraint fully out.

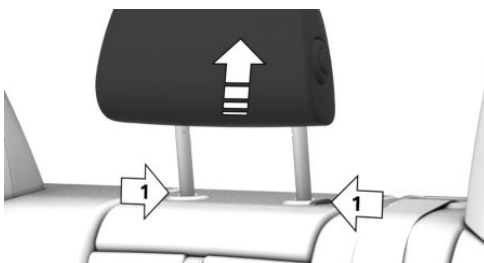

Installing head restraints

Proceed in the reverse order to install the head restraint.

After installation, make sure that the head restraint engages correctly.

Exterior mirrors

General

The exterior mirror adjustment is stored in the active BMW ID or in the active driver profile. If the BMW ID or the driver profile is reactivated at a later time, the stored position is loaded automatically.

The current exterior mirror adjustment can be stored using the memory function.





Safety information

WARNING

Objects reflected in the mirror are closer than they appear. The distance from road users behind the vehicle could be incorrectly estimated, for example when changing driving lane. There is a risk of accident. Look over your shoulder to estimate the distance from following traffic.

Overview





Icon	Meaning
	Fold the exterior mirrors in and out.
	Adjust the exterior mirrors.
	Select left exterior mirror, automatic parking function.
	Select right exterior mirror.

Adjusting the exterior mirrors

-  Press the key.
The selected exterior mirror moves along with the button movement.

Selecting the exterior mirror

-  Press the button to select the left exterior mirror. The LED is illuminated.
-  Press the button to select the right exterior mirror. The LED is illuminated.

Malfunction

In case of an electrical failure, adjust the exterior mirror by pressing on the edges of the mirror glass.

Folding in/folding out the exterior mirror

NOTICE

Because of its width, the vehicle could sustain damage in car washes. There is a risk of material damage. Before washing, fold the mirrors in manually or with the button.

 Press the key.

The mirrors can be folded in at vehicle speeds up to approx. 20 km/h/15 mph.

Folding the exterior mirrors in and out is helpful in the following situations:

- ▷ In car washes.
- ▷ In narrow streets.

Mirrors which are folded in automatically fold out when the vehicle reaches a speed of approximately 40 km/h/25 mph.

Automatic heating

When required, both exterior mirrors are automatically heated when drive-ready state is switched on.

Automatic dimming

The exterior mirror on the driver's side is dimmed automatically. Photocells in the interior mirror are used to control this function.

Automatic parking function

Principle

When reverse gear is engaged, the mirror glass on the passenger's side is tilted downwards. When parking, for example, this gives the driver a better view of the kerb or other objects near the ground.

Activating the automatic parking function

1.  Press the button. The LED is illuminated.
2. Engage selector lever position R.

The automatic parking function is deactivated when the trailer socket is occupied.

Deactivating the automatic parking function

 Press the key. The LED is illuminated and the LED of the driver's exterior mirror turns off.

Rear-view mirror with automatic anti-dazzle function

General

The interior mirror is dimmed automatically. The function is controlled by photocells:

- ▷ In the mirror glass.
- ▷ On the back of the mirror.

Overview



Operating requirements

- ▷ Keep the photocells clean.
- ▷ Do not obstruct the zone between the interior mirror and the windscreen.

Steering wheel

Safety information

WARNING

Adjusting the steering wheel while driving may cause the steering wheel to move unexpectedly. You could lose control of the vehicle. There is a risk of accident. Only adjust the steering wheel when the vehicle is at a standstill.

Electrical steering wheel adjustment

General

The steering wheel adjustment is stored in the active BMW ID or in the active driver profile. If the BMW ID or the driver profile is reactivated at a later time, the stored position is called up automatically.

The current steering wheel position can be saved with the memory function.

Temporarily, the steering wheel moves to the highest position to facilitate getting into and out of the vehicle.

Adjusting the steering wheel position

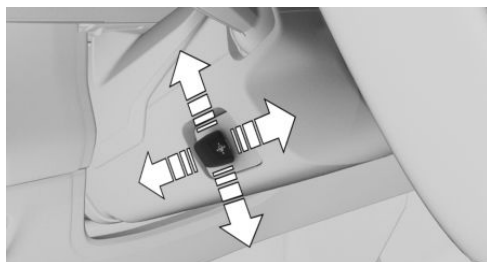

Press the switch to adjust the steering wheel to the correct forward/back position and height for your seat position.

Manual steering wheel adjustment

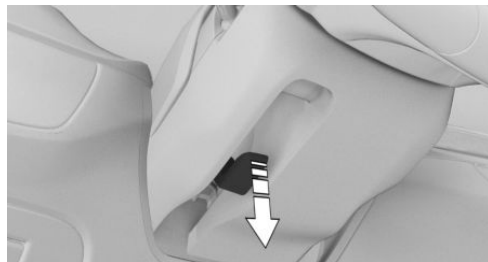

1. Fold the lever down fully.
2. Grip the steering wheel with both hands and adjust it in the longitudinal direction and height of the seat position.
3. Fold the lever back up.

Memory function

Principle

The memory function enables the following settings to be stored and retrieved when required:

- ▷ Seat position.
- ▷ Exterior mirror adjustment.
- ▷ Depending on the equipment: steering wheel position.
- ▷ Height of the Head-up display.

General

For each driver profile, two memory slots can be assigned with different settings.

The following settings are not saved:

- ▷ Backrest width.
- ▷ Lumbar support.

Safety information

WARNING

Using the memory function while driving may cause the seat or steering wheel to move unexpectedly. You could lose control of the vehicle. There is a risk of accident. Only use the memory function when the vehicle is at standstill.

WARNING



There is a risk of entrapment when the seats are moved. There is a danger of injury or material damage. Before making any adjustment, make sure that the movement range of the seat is clear.

Memory function

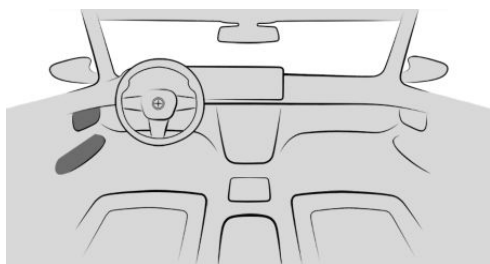
Overview



The memory buttons are on the front doors.

Icon	Meaning
	SET button
	Memory button 1
	Memory button 2

Storing settings

Using the button:

1. Set the desired position.
2.  Press the button. The LED is illuminated.
3. Press the desired memory button as long as the LED is lit. A signal sounds.

Via iDrive:

1.  Apps menu
2. "Vehicle"
3. "Seat comfort"
4. Select the desired seat.
5. "Seat position"
6. Save the desired seat position.

Go to Settings

Using the button:

Press the desired Memory button 1 or 2.

The saved position is retrieved.

The operation is halted when a seat setting switch or one of the memory buttons is pressed again.

The adjustment of the seat position on the driver's side is interrupted after a short time while driving.

Via iDrive:

1.  Apps menu
2. "Vehicle"
3. "Seat comfort"
4. Select the desired seat.
5. "Seat position"
6. Select the desired seat position.

Seat climate control

Various air conditioning functions are available for the seats.

For further information:

Air conditioning control, see page [291](#).

Carrying children safely

Vehicle equipment

This chapter describes equipment, systems and functions which are offered or may be offered in future on a model-specific basis, even if they are not included in the vehicle in question.

For further information:

Vehicle equipment, see page 8.

Important considerations

Safety information

 **WARNING**

Unsupervised children or pets in the vehicle can set the vehicle in motion and endanger themselves and other road users, for example, by the following actions:

- ▷ Pressing the Start/Stop button.
- ▷ Releasing the parking brake.
- ▷ Opening and closing doors or windows.
- ▷ Engaging selector lever position N.
- ▷ Operating vehicle equipment.

There is a risk of accident or injury. Do not leave children or pets unsupervised in the vehicle. When leaving the vehicle, take the vehicle key with you and lock the vehicle.

 **WARNING**

Hot vehicle can have fatal consequences, in particular for children or pets. There is a danger of injury or danger to life. Do not leave anyone unsupervised in the vehicle, especially children or animals.

 **WARNING**

Child restraint systems and their parts can get very hot when exposed to direct sunlight. Contact with hot parts can cause burns. There is a danger of injury. Do not expose the child restraint system to direct sunlight; cover the child restraint system if necessary. If required, allow the child restraint system to cool down before transporting a child. Do not leave children unsupervised in the vehicle.

Children on the rear seat

General

Accident research has shown that the safest place for children is on the rear seat.

Wherever possible, children younger than 12 years old or shorter than 150 cm, 5 ft should be transported only on the rear seats in child restraint systems appropriate for their age, weight and stature. Children aged 12 years and older must be secured with a seat belt once a suitable child restraint system is no longer an option due to their age, weight or stature.

Safety information

 **WARNING**

Children shorter than 150 cm, 5 ft cannot wear the seat belt correctly without using additional child restraint systems. The protective effect of the seat belts may be restricted or may even fail completely if the seat belts are worn incorrectly. If a seat belt is not worn correctly, additional injuries can be caused, for example in the event of an accident, braking or avoidance manoeuvre. There is a danger of injury or danger to life. Children shorter



than 150 cm, 5 ft must be secured in suitable child restraint systems.

Not for Australia: Children on the front passenger seat

General

When using a rearward-facing child restraint system on the front passenger seat, make sure that the front passenger airbag is deactivated.

If it is not possible to deactivate the front passenger airbag, do not carry children in rearward-facing child restraint systems on the front passenger seat.

For further information:

Deactivation of the front passenger airbag, see page 186.

Safety information

DANGER

If triggered, an active front passenger airbag can fatally injure a child in a child restraint system which is mounted facing backwards. There is a danger to life. Make sure that the front passenger airbag is deactivated and the PASSENGER AIRBAG OFF indicator light is illuminated.

Fitting child restraint systems

General

Please comply with the operating and safety instructions provided by the child restraint system manufacturer when selecting, attaching and using child restraint systems.

Safety information

WARNING

If child restraint systems and their attachment systems have been damaged or subjected to stresses in an accident, their protective effect may be restricted or may fail completely. A child might not be adequately restrained, for example in the event of an accident, braking or avoidance manoeuvre. There is a danger of injury or danger to life.

Do not continue to use child restraint systems which are damaged or have been subjected to stresses in an accident.

If attachment systems have been damaged or subjected to stresses in an accident, have them checked and replaced by an authorised Service Partner or another qualified Service Partner or a specialist workshop.

WARNING

If the seat is not set properly or the child seat has been installed incorrectly, the child restraint system may have restricted or no stability at all. There is a danger of injury or danger to life. Make sure that the child restraint system rests firmly against the seat backrest. Wherever possible, adapt the backrest angle of all relevant seat backrests and adjust the seats correctly. Make sure that the seats and their backrests are correctly engaged or locked. If possible and if necessary, adjust the height of the head restraints or remove them.

For Australia: installation of child restraint systems

Please note the following warning because your vehicle has been equipped with a front airbag for the front passenger seat that cannot be deactivated:



It is not recommended to use rearward-facing child restraint systems on the front passenger seat.

Extreme hazard

Do not use rearward-facing child restraint systems on a seat protected by an airbag in front of it.

Not for Australia: On the front passenger seat

Deactivating the airbag

DANGER

If triggered, an active front passenger airbag can fatally injure a child in a child restraint system which is mounted facing backwards. There is a danger to life. Make sure that the front passenger airbag is deactivated and the PASSENGER AIRBAG OFF indicator light is illuminated.

Before installing a rearward-facing child restraint system on the front passenger seat, make sure that the front passenger airbag is deactivated. If the airbag cannot be deactivated, do not install a rearward-facing child restraint system.

For further information:

Deactivation of the front passenger airbag, see page 186.

Rearward-facing child restraint systems

DANGER

If triggered, an active front passenger airbag can fatally injure a child in a child restraint system which is mounted facing backwards. There is a danger to life. Make sure that the

front passenger airbag is deactivated and the PASSENGER AIRBAG OFF indicator light is illuminated.



Follow the note on the sun visor on the passenger's side.

Never use rearward facing child restraint systems on a seat with an activated front airbag. Use may result in death or serious injury to children.

Seat position and height

After installing a universal child restraint system, move the front passenger seat as far back as it will go and adjust it to the lowest position. This seat position and height provides the best possible belt routing and protection in the event of an accident.

After installing a universal child restraint system, adjust the inclination of the seat backrest to achieve the best possible belt routing.

If the upper attachment point of the seat belt is in front of the child seat's seat belt guide, carefully move the front passenger seat forwards until the best possible seat belt guide is achieved.

Backrest width

With adjustable backrest width: before installing a child restraint system on the front passenger seat, fully open the backrest width. Do not change the backrest width from this point on and do not retrieve a seat position from the memory.

ISOFIX or i-Size child safety seat fasteners

General

Please comply with the operating and safety instructions provided by the, child restraint system manufacturer when selecting, attaching and using ISOFIX or i-Size child restraint systems.

Suitable ISOFIX or i-Size child restraint systems

For further information:

Suitable seats for child restraint systems, see page [128](#).



i-Size child restraint systems

General

i-Size is a legal regulation for child restraint systems which is used for the approval of child restraint systems.

The system represents a further development of the ISOFIX child safety seat fasteners.

ISOFIX child restraint systems can also be attached to anchors with i-Size markings.

Icon	Meaning
	If this icon is seen in the vehicle, the vehicle has also been approved in accordance with i-Size. The icon shows the mounts for the system's lower anchors. The lower anchors meet the European i-Size requirements.
	The corresponding icon shows the top tether eyelet.

ISOFIX child restraint systems

General

ISOFIX is a legal regulation for child restraint systems which is used for the approval of child restraint systems.

ISOFIX child restraint systems can be attached to mountings marked with ISOFIX.

Only certain ISOFIX child restraint systems are permitted for use on the designated seats. The associated size class and size category are denoted by a letter or ISO reference on a plate on the child seat.

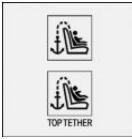
Icon	Meaning
	If this icon is seen in the vehicle, the vehicle has been approved in accordance with the ISOFIX standard. The icon shows the mounts for the system's lower anchors. The lower mountings comply with ISOFIX requirements.
	With universal approval: the corresponding icon shows the top tether attachment point.

Fixtures for lower anchors

General

Note the following when fitting child restraint systems with integrated safety belt to the mounts for the lower anchors:

The total weight of the child and child restraint system must not exceed 33 kg, 73 lb.

Safety information

WARNING

If the child restraint system lower anchors are not engaged correctly, the protective effect of the child restraint system will be restricted. There is a danger of injury or danger to life. Make sure the lower anchor points have engaged correctly and the child restraint system rests firmly against the backrest.

WARNING

The mounts for the lower anchors and the attachment points for child restraint systems are intended for attaching child restraint systems only. If other objects are attached, the mounts or attachment points can be damaged. There is a danger of injury or material damage. Only attach child restraint systems to the corresponding mounts for the lower anchors or the attachment points.

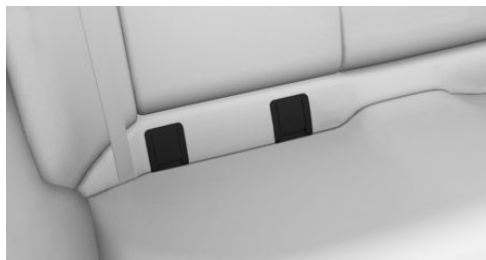

The fixtures for the lower anchors are located behind the marked covers. To expose the anchorage points, open the flaps upwards.



Before fitting child restraint systems

Pull the seat belt away from the area of the child seat mountings.

Fitting child restraint systems

1. Install child restraint system, see the manufacturer's instructions.
2. Make sure that the child restraint system attachment correctly engages in the lower anchor on both sides.

Position

Icon	Meaning
	The corresponding icon shows the fixtures for the lower ISO-FIX anchors or i-Size mounting.
	
	

Child restraint systems with upper restraint strap

General

When attaching child restraint systems to the upper attachment points, observe the information, operating and safety instructions of the child restraint system manufacturer.

Safety information

WARNING

If the upper retaining strap is used incorrectly on the child restraint system, the protective effect will be reduced. There is a danger of injury. Make sure that the upper retaining

strap is not twisted and is not routed to the upper attachment point over sharp edges.

WARNING

If the rear seat backrest is not locked, the protective effect of the child restraint system will be restricted or lost. The rear seat backrest may fold forward in certain situations, for example in the event of braking manoeuvre or an accident. There is a danger of injury or danger to life. Make sure that the rear seat backrests are locked.

WARNING

The mounts for the lower anchors and the attachment points for child restraint systems are intended for attaching child restraint systems only. If other objects are attached, the mounts or attachment points can be damaged. There is a danger of injury or material damage. Only attach child restraint systems to the corresponding mounts for the lower anchors or the attachment points.

Attachment points for upper retaining strap

Icon

Meaning



The corresponding icon shows the top tether eyelet.



Depending on the equipment, there are two or three attachment points for the upper retaining strap of child restraint systems.

Routing the retaining strap

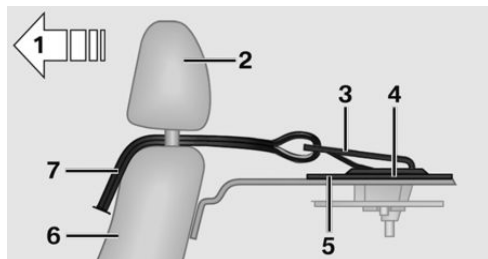

- 1 Direction of travel
- 2 Head restraint
- 3 Hook of the upper retaining strap
- 4 Attachment point
- 5 Parcel shelf
- 6 Seat backrest
- 7 Upper retaining strap

Attaching the upper retaining strap to the attachment point

1. Open the cover of the attachment point.
2. Raise the head restraint.
3. Guide the upper retaining strap between the head restraint mounts or along both sides of the head restraint mounts to the attachment point.

4. Attach the hook of the retaining strap to the attachment point.
5. Pull the retaining strap taut.

Seats for child restraint systems, see page 414.

Suitable seats for child restraint systems

General

The legal provisions determining which child seat is permitted for which age and body size may vary from country to country. Please comply with the relevant national legal provisions.

Additional information is available from an authorised Service Partner or another qualified Service Partner or a specialist workshop.

For detailed information about using child restraint systems:

Seats and child restraint systems

The following section provides information on which child restraint system is suitable for which seat in the vehicle.

Left-hand drive vehicles, seats:

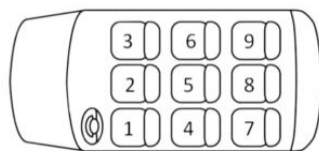

Seat	Airbag, front passenger	Mounting				
1						
3 a)	ON only forward-facing child restraint system					
	OFF only rearward facing child restraint system					
4, 6 – b)						
						e)

Seat	Airbag, front passenger	Mounting
------	-------------------------	----------

5 – c, d)



- a) Move the front passenger seat as far back as it will go and adjust it to the lowest position. Then adjust the angle of the backrest to achieve the best possible belt routing.
- b) When using child restraint systems on the rear seats, adjust the longitudinal direction of the front seat if necessary and, if possible and necessary, adjust or remove the head restraint of the rear seat.
- c) Only use the outer seats if the seat belt buckles are easily accessible.
- d) The seat is not suitable for child restraint systems with a support stand.
- e) Depending on the equipment or national-market version.

Right-hand drive vehicle, seats:

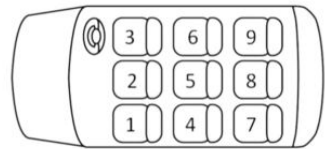

Seat	Airbag, front passenger	Mounting
------	-------------------------	----------

1 a) ON only forward-facing child restraint system



OFF only rearward facing child restraint system



3



4, 6 – b)



e)

Seat Airbag, front passenger Mounting

5 – c, d)



- a) Move the front passenger seat as far back as it will go and adjust it to the lowest position. Then adjust the angle of the backrest to achieve the best possible belt routing.
- b) When using child restraint systems on the rear seats, adjust the longitudinal direction of the front seat if necessary and, if possible and necessary, adjust or remove the head restraint of the rear seat.
- c) Only use the outer seats if the seat belt buckles are easily accessible.
- d) The seat is not suitable for child restraint systems with a support stand.
- e) Depending on the equipment or national-market version.

Icon	Meaning	Icon	Meaning
	Not suitable for child restraint systems.		Suitable for ISOFIX child restraint systems.
	Suitable for belted child restraint systems in the Universal category.		Suitable for ISOFIX and i-Size child restraint systems.
	Suitable for child restraint systems in the semi-universal category if the vehicle and seat are given in the list of vehicle types from the manufacturer of the child restraint system.		Suitable for child restraint systems with an upper retaining strap.

Recommended child seats

Please comply with the operating and safety instructions provided by the child restraint system manufacturer when selecting, attaching and using child restraint systems.

The manufacturer of the vehicle recommends the following child restraint systems:

- ▶ Maxi-Cosi Pebble 360.
- ▶ Maxi-Cosi FamilyFix 360 Base.
- ▶ With i-Size: Römer TRIFIX 2.
- ▶ With ISOFIX: Römer Duo Plus.
- ▶ Römer KIDFIX series.
- ▶ Cybex Solution Z i-Fix.

For Australia: Child restraint systems

General

In accordance with ADR 34/03, provisions have been made to allow installation of a child restraint system at each rear seat position.

The anchoring hooks which belong to the upper restraining strap of the child restraint system - AS 1754, can be applied immediately to the relevant mount.

Please refer strictly to the installation instructions supplied with the child restraint system.

Each seat position is fitted with a head restraint.

Safety information

WARNING

Anchorage for child restraint systems are designed to withstand only those loads imposed by correctly fitted child restraint systems. Under no circumstances are they to be used for adult seat belts, harnesses or for attaching other items or equipment to the vehicle. After using and removing child restraint systems, fold away the anchor brackets if necessary.



WARNING

If the rear seat backrest is not locked, the protective effect of the child restraint system will be restricted or lost. The rear seat backrest may fold forward in certain situations, for example in the event of braking manoeuvre or an accident. There is a danger of injury or danger to life. Make sure that the rear seat backrests are locked.

WARNING

If the upper retaining strap is used incorrectly on the child restraint system, the protective effect will be reduced. There is a danger of injury. Make sure that the upper retaining strap is not twisted and is not routed to the upper attachment point over sharp edges.

Attachment points

Icon	Meaning
	The corresponding icon shows the top tether eyelet.
	



Depending on the equipment, there are two outer attachment points or three other attachment points for child restraint systems with tether straps.

Routing the retaining strap

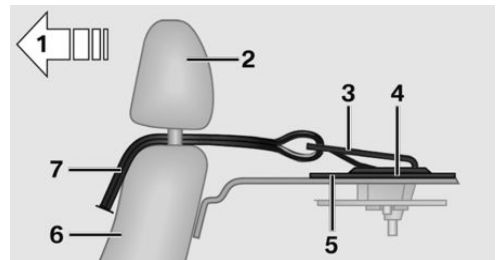

- 1 Direction of travel
- 2 Head restraint
- 3 Hook of the upper retaining strap
- 4 Attachment point
- 5 Parcel shelf
- 6 Seat backrest
- 7 Upper retaining strap

Attaching the upper retaining strap to the attachment point

1. Open the cover of the attachment point.
2. Push the head restraint up or remove it.
3. Guide the upper retaining strap between the head restraint mounts or along both sides of the head restraint mounts to the attachment point.

Middle seat: guide the upper retaining strap over the head restraint.

4. Attach the hook of the retaining strap to the attachment point.
5. Pull the retaining strap taut.

Rear safety switch

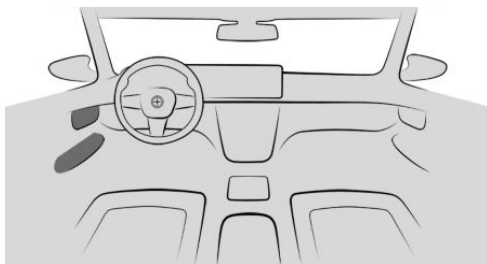

Press the button on the driver's door. Different functions are locked and cannot be operated in the rear, for example the window lifters.

Securing doors and windows in the rear

General

In certain situations, for example when carrying children, it may be advisable to secure the rear doors and windows.

Doors



Unlock or lock the safety switches on the rear doors with the integrated key. To lock, turn in the corresponding direction of the arrow on the door.

The respective door can now only be opened from the outside.

Driving

Vehicle equipment

This chapter describes equipment, systems and functions which are offered or may be offered in future on a model-specific basis, even if they are not included in the vehicle in question.

For further information:

Vehicle equipment, see page 8.

Start/Stop button

Principle

Drive-ready state is switched on and off by pressing the Start/Stop button.

General

Drive-ready state is switched on by pressing the Start/Stop button with the brake applied.

Pressing the Start/Stop button again switches drive-ready state off again and standby state is switched on.

For further information:

- ▶ Drive-ready state, see page 49.
- ▶ Standby state, see page 48.

Driving off

1. Switch on drive-ready state.
2. Select the drive position.
3. Drive off.

When stopping

Selector lever positions D, S or R

On uphill gradients, the system prevents the vehicle from rolling against the selected direc-

tion of travel and provides assistance when driving off.

Driving off

To drive off, press the accelerator pedal.

The parking brake is automatically released.

Depending on the vehicle load and driving situation or in trailer operation, the vehicle may roll backwards a little.

Acoustic protection for pedestrians

Depending on the equipment and national-market version, acoustic protection for pedestrians generates continuous driving noise in vehicles with electric or electrically assisted drives.

- ▶ With a stationary vehicle and turned on drive-ready state as soon as the selector lever position P is exited.
- ▶ With electric driving up to 30 km/h/20 mph.

A loudspeaker system plays the noise outside the vehicle. As a result, other road users, for example pedestrians or cyclists, can detect the vehicle better.

Automatic Start/Stop function

Principle

The Automatic Start/Stop function helps you to save fuel. It does this by switching off the engine when the vehicle stops, for example in congestion or at traffic lights. Drive-ready state remains switched on. For driving off, the engine starts automatically.



General

Each time the engine is started via the Start/Stop button, the Automatic Start/Stop function is switched to standby.

The function is activated at low speeds.

Engine shutdown

Operating requirements

The engine is automatically shut down when stationary when the following conditions are met:

- ▶ Selector lever in selector lever position D.
- ▶ Brake pedal remains pressed while the vehicle is at a standstill or the vehicle is kept stationary by Automatic Hold.
- ▶ Driver's seat belt fastened or driver's door closed.

Manual engine shutdown

If the engine was not switched off automatically when the vehicle came to a stop, it can be switched off manually:

- ▶ Rapidly press the brake pedal from the current position.
- ▶ Engage selector lever in position P.

If all the operating requirements have been met, the engine is stopped.

Air conditioning when the vehicle is parked

The amount of air of the air conditioning is reduced when the engine is not running.

Display in the instrument cluster



READY

The display in the instrument cluster indicates that the Automatic Start/Stop function is ready for automatic engine start.

Functional limitations

The engine is not shut down automatically in the following situations:

- ▶ On a steep downhill gradient.
- ▶ The brake pedal has not been pressed hard enough.
- ▶ When the outside temperature is high and the automatic air conditioning is switched on.
- ▶ Interior is not heated or cooled to the desired temperature.
- ▶ Where there is a risk of condensation when the automatic air conditioning is switched on.
- ▶ Engine or other parts are not at operating temperature.
- ▶ Engine cooling is required.
- ▶ Vehicle battery charge state very low.
- ▶ At high altitudes.
- ▶ The bonnet is unlocked.
- ▶ Park Assist is activated.
- ▶ For stop-and-go traffic.
- ▶ After reversing.
- ▶ When using fuel with high ethanol content.

Engine start

Operating requirements

For driving off, the engine starts automatically under the following conditions:

- ▶ By releasing the brake pedal.
- ▶ With Automatic Hold activated: press the accelerator pedal.

Driving off

Accelerate as usual after starting the engine.

Safety function

After an automatic shut down, the engine will not restart automatically if one of the following conditions is met:

- ▶ Driver's seat belt unfastened and driver's door open.
- ▶ Bonnet has been unlocked.

Several indicator lights illuminate for various lengths of time.

The engine can only be started using the Start/Stop button.

System limits

Even if you do not want to drive off, the engine restarts automatically in the following situations:

- ▶ In case of excessive warming of the interior when the air conditioning function is turned on.
- ▶ In case of excessive cooling of the interior when the heating is turned on.
- ▶ Where there is a risk of condensation when the automatic air conditioning is switched on.
- ▶ When changing the selector lever position from D or P.
- ▶ In case of seriously discharged vehicle battery.
- ▶ When starting an oil level measurement.

Manually deactivating the system

Principle

The engine is not switched off automatically.

During an automatic engine shutdown, the engine is started.

Via iDrive

1.  Apps menu
2. "Vehicle"
3. "Driving settings"

4. "Drivetrain and chassis"
5. "Auto Start/Stop"
6. Select the desired setting.

Via selector lever position or drive mode

The Automatic Start/Stop function is deactivated by the following:

- ▶ if the selector lever is in position S.
- ▶ In drive mode: "SPORT".

Parking the vehicle during automatic engine shutdown

During an automatic engine shutdown, the vehicle can be parked safely, for example in order to exit it.

1. Press the Start/Stop button.
 - ▶ Drive-ready state is switched off.
 - ▶ Standby state is switched on.
 - ▶ Selector lever position P is automatically engaged.
2. Apply the parking brake.

Automatic deactivation

In certain situations the Automatic Start/Stop function is deactivated automatically for safety reasons, for example if the absence of the driver is detected.

Malfunction

The Automatic Start/Stop function no longer shuts down the engine automatically. A Check Control message is shown. It is possible to continue driving. Have the system checked by an authorised Service Partner or another qualified Service Partner or a specialist workshop.



Steptronic transmission

Principle

The Steptronic transmission is the vehicle's automatic transmission. With the shift paddle, there is the option of changing gear manually if required.

Safety information

WARNING

An unsecured vehicle can start moving and roll away. There is a risk of accident. Before leaving the vehicle, secure the vehicle against rolling away by, for example, applying the parking brake.

Selector lever positions

D Drive position

Selector lever position for all normal driving. All gears for driving forwards are selected automatically.

R Reverse gear

Only engage selector lever position R when the vehicle is stationary.

N Neutral

In selector lever position N, the vehicle can be pushed or can roll without drivetrain power, for example in car washes.

P Park

General

Selector lever position once the vehicle is parked, for example. In selector lever position P, the transmission blocks the drivetrain.

P is engaged automatically

Selector lever position P is automatically engaged in situations such as the following:

- ▷ After switching off the drive-ready state when selector lever position R, D, or S is engaged.
- ▷ After switching off the standby state when selector lever position N is engaged.
- ▷ The driver's seat belt is unfastened and the driver's door is opened when the vehicle is stationary and selector lever position D, S or R is engaged.

Before exiting the vehicle, make sure that selector lever position P is engaged and the parking brake is engaged. The vehicle could otherwise start to move.

For further information:

Parking brake, see page 144.

Engaging selector lever positions

General

Apply the brake until ready to drive off, otherwise the vehicle will move when drive position or reverse gear is selected.

Operating requirements

The selector lever will only move from position P to another selector lever position if drive-ready state is switched on and the brake is pressed.

It may not be possible to move out of selector lever position P until all technical conditions are met.

Engaging selector lever position D, N, R

1. Fasten the driver's seat belt.
2. Tilt or pull the selector lever into the desired direction, past a resistance point, if needed.

The selector lever returns to the centre position when released.

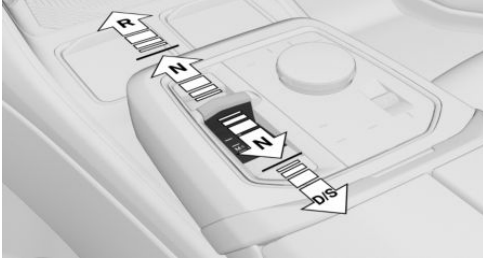

Engaging selector lever position P



 Press the key.
The electromechanical parking brake is applied and transmission lock is engaged.

Rolling or pushing the vehicle

General

In some situations, the vehicle may need to roll a short distance without drivetrain power, for example in a conveyor car wash, or when being pushed.

Engaging selector lever position N

NOTICE

The selector lever position P is automatically engaged when standby state is switched off. The wheels are locked. There is a risk of material damage. Do not switch off standby

state if the vehicle is to roll, e.g. in conveyor car washes.

1. Switch on drive-ready state while pressing the brake.
2. Press the brake.
3. Engage selector lever position N.
4. Switch off drive-ready state.

Standby state then remains switched on and a Check Control message is shown.

The vehicle can now roll.

Selector lever position P is automatically engaged after approximately 35 minutes.

If there is a fault, it may not be possible to change the selector lever position.

Unlock the parking lock electronically if necessary.

For further information:

Unlocking the parking lock electronically, see page [138](#).

Kickdown

Kickdown is used to achieve maximum performance.

Press the accelerator pedal down beyond the regular full-throttle position; some resistance will be felt.

Sport programme S

Principle

In the Sport programme, the gear shift points and gear shift times are configured for more sporty driving. For example, the transmission shifts up later and the gearshift times are shorter.

Activating the Sport programme



Pull the selector lever out of selector lever position D to D/S.

The gear selected is displayed in the instrument cluster, for example S1.

The Sport programme of the transmission is activated.

Ending Sport programme

Pull the selector lever to D/S.

D is shown in the instrument cluster.

Displays in the instrument cluster

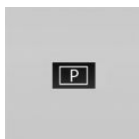

The selector lever position is displayed, for example P.

Unlocking the parking lock electronically

General

Unlock the transmission lock electronically, e.g. to manoeuvre the vehicle out of a danger area in the event of a fault.

Before unlocking the parking lock, secure the vehicle to prevent it from rolling away, for example with a chock.

Engaging selector lever position N

1. Press the Start/Stop button three times quickly; do not press the brake when doing so.
2. Press the brake.
3. Press the selector lever to position N.
A corresponding Check Control message is shown.
Position N is displayed on the selector lever.
4. Manoeuvre the vehicle out of danger and then secure it against rolling away.

Shift paddles

Principle

The shift paddles on the steering wheel enable the gears to be changed manually.

General

Gearshift

Gear shifting is only carried out at the appropriate rotational speed and vehicle speed.

Even in manual mode, the transmission switches automatically in certain situations, e.g. when speed limits are reached.

Temporary manual mode

In selector lever position D, pulling a shift paddle causes the system to switch to manual mode temporarily.

The gear selected is also displayed in the instrument cluster, for example D1.

The transmission reverts to automatic mode from manual mode after a certain period of time of moderate driving without acceleration or gear shifts using the shift paddles.

It is possible to change to automatic mode:

- ▶ Pull and hold the right shift paddle until D is shown in the instrument cluster.
- ▶ While pulling and holding the right shift paddle, pull the left shift paddle.

Permanent manual mode

In Sport programme S, pulling a shift paddle causes the system to switch permanently to manual mode M.

The gear selected is displayed in the instrument cluster, for example M1.

It is possible to change to automatic mode:

- ▶ Pull and hold the right shift paddle until S is shown in the instrument cluster.
- ▶ While pulling and holding the right shift paddle, pull the left shift paddle.
- ▶ Pull the selector lever to D/S.

If M2 is set manually while the vehicle is stationary, the transmission will no longer shift back to M1. These shift characteristics are retained until M1 is engaged manually or manual mode M is exited.

Shifting gears



- ▶ To shift up: pull the right shift paddle.
- ▶ To shift down: pull the left shift paddle.

The gear selected appears briefly in the instrument cluster, followed by the gear currently in use.

Advanced mode

General

Depending on the equipment, the Steptronic transmission offers an advanced mode with adapted shift characteristics.

- ▶ Automatic downshift to the lowest possible gear.
If the left shift paddle is pulled and held, the Steptronic transmission automatically shifts down to the lowest possible gear.
- ▶ Avoid automatic upshifting in manual mode.
The Steptronic transmission does not shift up automatically in manual mode when speed limits are reached.
- ▶ There is no downshift for kickdown.

Activating advanced mode

Advanced mode is active in manual mode when Dynamic Stability Control is deactivated.

Depending on the equipment, the advanced mode can also be activated in manual mode as follows:

- ▶ "SPORT PLUS": Setting under Drive in Sport Mode in My Modes.
- ▶ Increased driving dynamics is activated.

Launch Control

Principle

When the ambient conditions are dry, Launch Control permits optimised acceleration on a road surface that offers plenty of grip.

General

Using Launch Control causes premature component wear, as this feature subjects the vehicle to very high stresses and loads.

When driving off with Launch Control, do not turn the steering wheel.



Do not use Launch Control when running in.

For further information:

Running in, see page 324.

Operating requirements

Launch Control is available when the engine is at operating temperature. The engine is at operating temperature after an uninterrupted journey of at least 10 km, 6 miles.

Start up with Launch Control

1. Switch on drive-ready state.



2. Press the button.

3. "Switch mode"

4. Select drive mode: "SPORT".

5. "Settings"

6. "Driving dynamics"

7. "SPORT PLUS"

8. Press the brake firmly with the left foot.

9. Depress the accelerator pedal all the way down and hold it.

A destination flag is shown in the instrument cluster.

10. The engine speed for pulling away is adjusted. Release the brake within 3 seconds.

The vehicle accelerates.

Launch Control remains active as long as the Launch Control information is displayed and the accelerator pedal remains depressed.

Using again during a journey

Once Launch Control has been used, the transmission requires a short time to cool down before Launch Control can be used again. Launch Control adapts to the ambient conditions when used again.

After using Launch Control

To support driving stability, reactivate Dynamic Stability Control as soon as possible.

System limits

An experienced driver may be able to achieve better acceleration values in DSC OFF mode without Launch Control.

Sport Boost function

Principle

The Sport Boost function can be used for an impending acceleration process, for example.

This system prepares the vehicle for the upcoming acceleration. The accelerator pedal has sportier response characteristics.

General

The Sport Boost function is operated using the shift paddles on the steering wheel.

Overview



The shift paddles for the Sport Boost function are located on the steering wheel.

Display in the instrument cluster

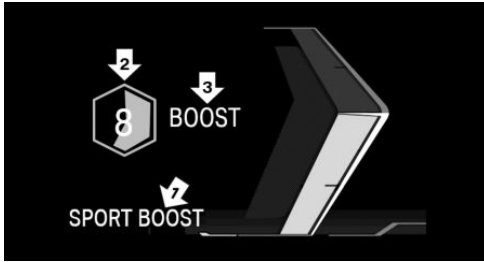

- ▷ Arrow 1: The function is active.
- ▷ Arrow 2: Countdown, the function is active.
- ▷ Arrow 3: The function is used for maximum acceleration.

Using the function

1. SPORT BOOST: Pull and hold the left shift paddle until this display appears, arrow 1.
 - ▷ The function is active.
 - ▷ A countdown is displayed in the instrument cluster, arrow 2.
2. Before the countdown changes to 0, press the accelerator pedal.
 - ▷ The vehicle accelerates.
 - ▷ BOOST: This display is shown in the instrument cluster, arrow 3.

The countdown can be restarted, e.g. if the function cannot be used immediately.

To restart the countdown, pull and hold the left shift paddle again until the countdown is reset.

Stopping the function

The function is automatically interrupted if the countdown to 0 has elapsed or the function was used in the acceleration process.

Deactivating the function

Pull and hold the right shift paddle until this display disappears.

My Modes

Principle

My Modes influence the handling of the vehicle and the customisation of the overall experience in the interior.

The vehicle can be adapted depending on the situation using the various My Modes.

General

Depending on the equipment, the following systems are affected, for example:

- ▷ Drivetrain.
- ▷ Steering.
- ▷ Suspension.
- ▷ Cruise Control.
- ▷ Display in the instrument cluster.
- ▷ Comfort functions in the vehicle interior.
- ▷ Drive sound.

Overview

Button in the vehicle

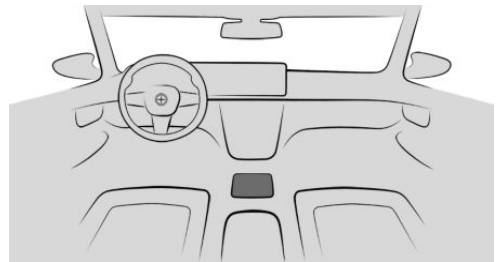

 My Modes

Displays in the instrument cluster



If applicable, the selected mode is displayed in the instrument cluster.

My Modes in detail

General

Different My Modes are available depending on the equipment.

My Modes that influence the driving characteristics are also referred to as drive mode.

Personal Mode

Drive mode for comfort oriented settings.

Sport Mode

Drive mode for increased agility of the vehicle.

Individual settings can be entered, for example, for driving dynamics, suspension and drivetrain.

"SPORT PLUS": with this setting under driving dynamics, the Dynamic Stability Control and thereby the driving stability will be restricted.

- ▷ Dynamic Stability Control, see page 223.
- ▷ Setting for increased driving dynamics, see page 224.

Efficient mode

Drive mode for a consumption optimised setting with predictive display.

For further information:

Efficient Mode, see page 342.

Additional My Modes

Depending on vehicle equipment, additional My Modes are available to change the ambience of the vehicle interior:

- ▷ Expressive Mode.
- ▷ Digital Art Mode.
- ▷ Relax Mode
- ▷ Silent Mode.

Selecting My Mode

1.  Press the button.
2. "Switch mode"
3. Select the desired mode.

Setting My Modes

Some modes can be set individually.

1.  Press the button.
2. Select mode.
3. "Settings"
4. Select the desired settings.

Changing start mode

Some modes can be set as start mode.

The set start mode is active when drive-ready state is switched on.

1.  Press the button.
2. Select mode.
3. "Settings"
4. "Start mode"

My Modes Design

The specific illustrations of a mode can be displayed in the control display under My Modes Design.

1.  Press the button.
2. "MyModes design"

My Programmes

Principle

A programme harmonises various vehicle functions in the interior to suit requirements.

By selecting a programme, the interior lighting, climate control and music selection will be adjusted, among others.

Safety information

WARNING

Persons remaining in the vehicle or pets left inside can lock the doors from the inside and lock themselves in. In this case, the vehicle cannot be opened from the outside. There is a danger of injury. Carry the vehicle key with you so that you can open the vehicle from the outside.

WARNING

With some national-market versions, unlocking from the inside requires specific knowledge.

There is a risk of severe or fatal injury if persons or animals remain in the vehicle for extended periods of time, which exposes them to extreme temperatures. Do not lock the vehicle from the outside if there are persons or animals inside. Do not leave babies, toddlers, or animals alone in the vehicle.

Operating requirements

To use these programmes, various requirements must be met:

"Vitalize":

- ▶ Selector lever position D is engaged.
- ▶ The driver's door is closed.

- ▶ Automatic air conditioning is turned on.
- ▶ Theatre Mode must be deactivated in My Modes.

"Power Nap":

- ▶ Standby state is switched on.
- ▶ The parking brake is engaged.
- ▶ All doors and flaps must be closed.
- ▶ Automatic air conditioning is turned on.
- ▶ The battery must be sufficiently charged.
- ▶ There must be not objects or persons on the rear bench seat.

My Programmes in detail

My Programmes	Description
"Vitalize"	This programme lasts three minutes and vitalises through music and certain comfort settings.
"Power Nap"	This programme creates a relaxing, sleepy atmosphere so that longer stationary periods can be used for rest.
"HAPPY KIDS"	The programme creates a sleep-promoting environment in the rear for children.

Activating/deactivating My Programmes

1.  Apps menu
2. "All apps"
3. ▶ "Vitalize"
 - ▶ "Power Nap"
 - ▶ "HAPPY KIDS"
4. Select the desired setting.

Parking brake

Principle

The parking brake is used to prevent the vehicle from rolling away when it is parked.

Safety information

WARNING

An unsecured vehicle can start moving and roll away. There is a risk of accident. Before leaving the vehicle, secure it in order to prevent it from rolling away.

Observe the following to ensure that the vehicle is secured against rolling away:

- ▷ Apply the parking brake.
- ▷ Turn the front wheels towards the kerb on uphill or downhill gradient.
- ▷ Additionally secure the vehicle on uphill or downhill gradient, for example with a chock.

WARNING

Unsupervised children or pets in the vehicle can set the vehicle in motion and endanger themselves and other road users, for example, by the following actions:

- ▷ Pressing the Start/Stop button.
- ▷ Releasing the parking brake.
- ▷ Opening and closing doors or windows.
- ▷ Engaging selector lever position N.
- ▷ Operating vehicle equipment.

There is a risk of accident or injury. Do not leave children or pets unsupervised in the vehicle. When leaving the vehicle, take the vehicle key with you and lock the vehicle.

Overview

Button in the vehicle

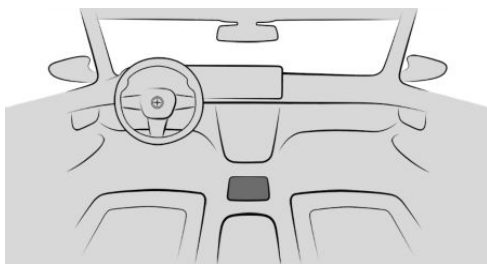

 Parking brake

Applying the parking brake

When the vehicle is stationary

 Press the key.
The LED is illuminated.

 The indicator light in the instrument cluster is illuminated red.
The parking brake is applied and transmission lock is engaged.

While driving

The parking brake can be used as an emergency braking function while driving:

 Press and hold the button. The vehicle brakes hard as long as the button is pressed.

 The indicator light in the instrument cluster is illuminated red, a signal sounds and the brake lights illuminate.

A Check Control message is shown.

The parking brake is engaged and the transmission lock is set when the vehicle is stationary.

Engaging the parking brake automatically

In some situations, the parking brake is engaged automatically, for example, by Automatic Hold.

Additionally, the system can be set to automatically engage the parking brake when the drive-ready state is switched off.

1.  Apps menu
2. "Vehicle"
3. "Driving settings"
4. "Drivetrain and chassis"
5. "Parking brake"
6. Select the desired setting.

In selector lever position N, the parking brake will not be engaged automatically.

Release the parking brake

Releasing the parking brake manually

1. Switch on drive-ready state.
2.  Press the button while pressing on the brake pedal.
The LED and the indicator light go out.
The parking brake is released.
The transmission lock remains engaged until a drive position is selected.

Releasing the parking brake automatically

The parking brake is automatically released on when you drive off.

The LED and the indicator light go out.

Using the parking brake via iDrive

The parking brake can also be engaged or disengaged via iDrive. Additionally, further information is displayed.

1.  Apps menu
2. "Vehicle"
3. "Driving settings"
4. "Drivetrain and chassis"
5. "Parking brake"
6. Select the desired setting.

Malfunction



If a parking brake has failed or malfunctioned, secure the vehicle to prevent it from rolling away before leaving the vehicle.

A Check Control message is shown.

After getting out, secure the vehicle to prevent it from rolling away, for example with a chock.

After an open circuit

To restore the operability of the parking brake after a power failure, an initialisation may be required.

1. Switch on standby state.
2.  Press the button.
3.  Press the button again after 2 seconds.

The Check Control messages for the parking brake go out.

Possible functional noises are normal.

-  The indicator light indicates that the parking brake is operational again.

Automatic Hold

Principle

Automatic Hold provides assistance by automatically applying and releasing the brake, for example in stop-and-go traffic.

When a drive position is engaged, the vehicle is automatically held in place at standstill.

On upward gradients, it prevents the vehicle from rolling back when driving off.

General

The parking brake is released automatically when the following conditions are met:

- ▷ Drive-ready state is switched off.
- ▷ If the driver's door is open for more than one second and no pedal is pressed during this time.
- ▷ If the moving vehicle is brought to a standstill with the parking brake.

In selector lever position N, Automatic Hold is temporarily deactivated.

Safety information

WARNING

An unsecured vehicle can start moving and roll away. There is a risk of accident. Before leaving the vehicle, secure it in order to prevent it from rolling away.

Observe the following to ensure that the vehicle is secured against rolling away:

- ▷ Apply the parking brake.
- ▷ Turn the front wheels towards the kerb on uphill or downhill gradient.
- ▷ Additionally secure the vehicle on uphill or downhill gradient, for example with a chock.

WARNING

Unsupervised children or pets in the vehicle can set the vehicle in motion and endanger themselves and other road users, for example, by the following actions:

- ▷ Pressing the Start/Stop button.
- ▷ Releasing the parking brake.
- ▷ Opening and closing doors or windows.
- ▷ Engaging selector lever position N.
- ▷ Operating vehicle equipment.

There is a risk of accident or injury. Do not leave children or pets unsupervised in the vehicle. When leaving the vehicle, take the vehicle key with you and lock the vehicle.

Overview

Button in the vehicle

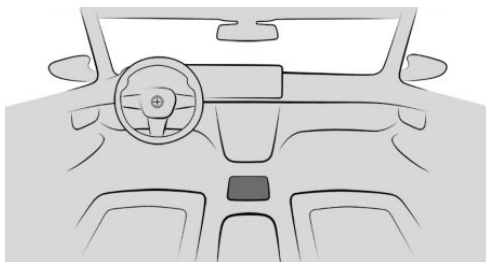

AUTO H Automatic Hold

Activate Automatic Hold

1. Switch on drive-ready state.

2. **AUTO H** Press the button.

The LED is illuminated.

AUTO H The indicator light illuminates green. Automatic Hold is activated.

When the vehicle is restarted, the last selected setting is retained.

Automatic Hold holds the vehicle

Automatic Hold is activated and the driver's door is closed.



Once the vehicle has stopped, it is automatically secured from rolling away once the indicator light lights up green.

Driving off

To drive off, press the accelerator pedal.

The brake is released automatically and the parking brake indicator light is extinguished.

Automatic parking brake application

The parking brake is applied automatically if drive-ready state is switched off or the vehicle is exited while Automatic Hold is holding the vehicle.



The indicator light changes from green to red.

The parking brake is not applied automatically if drive-ready state was switched off while the vehicle was rolling to a stop. Automatic Hold is temporarily deactivated in this case.

Deactivate Automatic Hold



Press the key.

The LED is extinguished.



The indicator light extinguishes.

Automatic Hold is deactivated.

If the vehicle is being held by Automatic Hold, also depress the brake when deactivating.

Displays

Vehicle equipment

This chapter describes equipment, systems and functions which are offered or may be offered in future on a model-specific basis, even if they are not included in the vehicle in question.

For further information:

Vehicle equipment, see page 8.

Instrument cluster

Principle

The instrument cluster comprises various digital displays, e.g., a speedometer, displays for time, range, temperature, or indicator/warning lights.

General

The layout of the instrument cluster adapts to the respective drive mode. The positions of some displays may vary, e.g. the selector lever indication.

The displays in the instrument cluster can sometimes differ from the illustrations in the Owner's Handbook.

Safety information

WARNING

If the displays in the instrument cluster fail, the vehicle must not be used. There is a risk of accident or material damage. Immediately park the vehicle safely. By switching drive-ready state off and on again, it may be possible to rectify the malfunction and continue driving. If the malfunction cannot be rectified, have the system checked by an authorised

Service Partner or another qualified Service Partner or a specialist workshop.

Overview

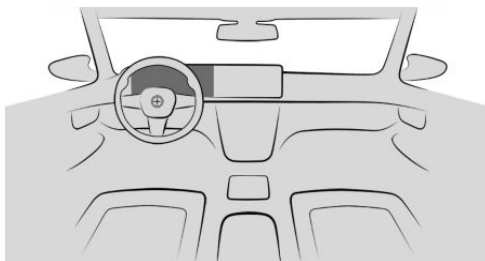

Instrument cluster

Indication ranges in the instrument cluster

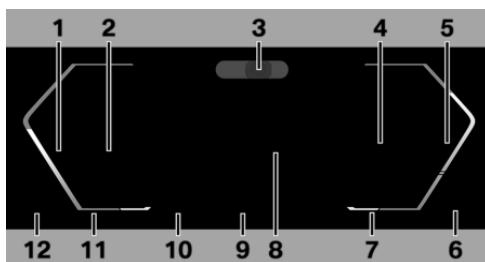

- 1 Speedometer
- 2 Driver assistance systems [227](#)
Parking assistance systems [260](#)
- 3 Driver Attention Camera [221](#)
- 4 Check Control [151](#)
Selector lever indication [136](#)
Optimum shift indicator [160](#)
Selection lists [159](#)
Efficiency Coach [342](#)
- 5 Power display [160](#)
Revolution counter [161](#)

- 6 Engine temperature [161](#)
- 7 Outside temperature [162](#)
- 8 Central display area [162](#)
Shift Lights [162](#)
- 9 My Modes drive mode [141](#)
- 10 Speed Limit Info [227](#)
Speed Limit Assist [253](#)
- 11 Time [165](#)
- 12 Fuel level indicator [166](#)
Range [166](#)

For further information:

Indicator and warning lights, see page [152](#)

Operating elements on the steering wheel

Operating Function element



Display the menu bar in the instrument cluster.



Turn the knurled wheel: scroll the selection up or down.
Tilt the knurled wheel in the corresponding direction: move the selection to the left or right.
Press the knurled wheel: confirm the selection.

Configuring the layout

In Personal Mode, the layout can be individually configured and displayed in the instrument cluster.



1.  Press the button on the steering wheel.
A menu bar is displayed in the instrument cluster.
2. "LAYOUT"

Select the menu by tilting the knurled wheel on the steering wheel as necessary.

3. Select the required setting using the knurled wheel on the steering wheel.

Settings

Individual displays can be set individually, e.g. a second actual speed.

1.  Apps menu
2. "Vehicle"
3. "Displays"
4. "Instrument cluster"
5. Select the desired setting.

Live Vehicle

Principle

Live Vehicle is a virtual representation of your own vehicle with different information, e.g. vehicle status or energy flow indicators.

General

Depending on the driving situation, suitable information is shown on the control display. Fault statuses are not taken into account.

Adaptive content

The following is displayed in alternating order and, if applicable, depending on the selected drive mode:

- ▷ Vehicle status, see page [167](#).
- ▷ Current driving condition, see page [167](#).
- ▷ Sport displays, see page [168](#).
- ▷ Efficiency Coach, see page [342](#).
- ▷ Trip data, see page [163](#).

Static content

The following content can be displayed continuously on the control display regardless of the driving situation and set drive mode.

- ▷ Vehicle status.
- ▷ Trip data.

Configuring the display

In the Live Vehicle menu, it is possible to choose between an adaptive display and static content.

1.  Apps menu
2. "Vehicle"
3. "Live Vehicle"
4. "Content"
5. Select the desired setting.

BMW Head-up display

Principle

The Head-up display projects important information on the windscreen in the driver's field of view, for example, the speed. Information can be perceived without looking away from the road.

The buttons on the steering wheel can be used to configure various views for the Head-up display. Further settings are possible on the control display, for example, brightness or height.

General

Follow the instructions on cleaning the head-up display in the Care chapter.

For further information:

Care of special parts, see page [407](#).

Overview

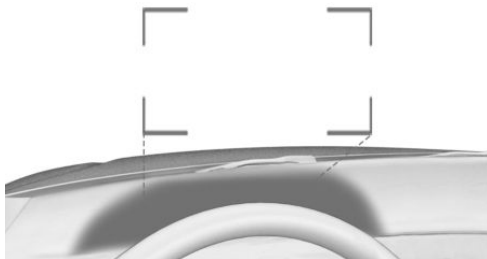

The head-up display displays are projected onto the windscreen by a protective glass. The protective glass is located between the steering wheel and the windscreen.

Displayable information

The following information is displayed in the Head-up display:

- ▷ Speed.
- ▷ Navigation instructions.
- ▷ Check Control messages.
- ▷ Sport displays.
- ▷ Shift Lights.
- ▷ Efficiency Coach.
- ▷ Lists and messages.
- ▷ Driver assistance systems.

Some of this information is only shown briefly when needed.

Configuring a view

The views for the Head-up display can be set independently of the display in the instrument cluster, for e.g. a reduced view.

1.  Press the button on the steering wheel.
A menu bar is displayed in the instrument cluster.
2. "HEAD-UP"

Select the menu by tilting the knurled wheel on the steering wheel as necessary.

3. Select the required setting using the knurled wheel on the steering wheel.

Turning the Head-up display on/off

1.  Apps menu
2. "Vehicle"
3. "Displays"
4. "Head-up display"
5. "Head-up display"

Settings

Individual settings can be entered for the Head-up display, for example for the height, brightness or illustration. In addition, individual displays in the Head-up display can be set up separately, for instance information on driver assistance.

1.  Apps menu
2. "Vehicle"
3. "Displays"
4. "Head-up display"
5. Select the desired setting.

Visibility of the display

The visibility of the information shown on the Head-up display can be affected by the following:

- ▷ The sitting position.
- ▷ Objects on the protective glass of the Head-up display.
- ▷ Dust or dirt on the protective glass on the head-up display.
- ▷ Dirt on the inside or outside of the windscreen.
- ▷ Sunglasses with certain polarisation filters.
- ▷ Wet roads.
- ▷ Adverse lighting conditions.

If the image is distorted, have the default settings checked by an authorised Service Partner or another qualified Service Partner or a specialist workshop.

Special windscreen

The windscreen is an integral part of the system.

The shape and coating of the special windscreen enable the system to function.

In the event of damage, have the special windscreen replaced by an authorised Service Partner or another qualified Service Partner or a specialist workshop.

Check Control

Principle

Check Control monitors vehicle functions and alerts you to any faults in the monitored systems.

A Check Control message is displayed as a combination of indicator or warning lights and text messages in the instrument cluster and, if applicable, in the Head-up display. An acoustic signal may also be output and a text message shown on the control display.

Some Check Control messages are hidden automatically after approximately 20 seconds and remain stored. The stored Check Control messages can be displayed on the control display. Urgent Check Control messages are continuously displayed and can be temporarily hidden.

Hiding Check Control messages

Permanently displayed Check Control messages may be temporarily hidden. After approx. 8 seconds, these messages are automatically displayed again.

◀ An arrow symbol next to the Check Control message indicates whether the Check Control message can be hidden.

 To hide Check Control messages, tilt the knurled wheel on the steering wheel to the left.

Displaying saved Check Control messages

Additional information, for example the cause of the fault and any action required, can be called up via Check Control.

It is possible to select additional assistance depending on the Check Control message.

1.  Apps menu
2. "Vehicle"
3. "Vehicle status"
4. "Check Control"
5. Select the required text message.

Display

A Check Control message is displayed on the instrument cluster as a text message with icon.

With urgent messages, additional instructions will be displayed automatically on the control display.

If a number of malfunctions have occurred at the same time, the messages are displayed in succession.

Certain messages displayed when driving are displayed again when drive-ready state is switched off.



Icons on the instrument cluster indicate an active or saved Check Control message.

Indicator lights and warning lights

Principle

The indicator lights and warning lights on the instrument cluster show the status of some vehicle functions. The indicator and warning lights indicate faults in monitored systems.

General

The indicator/warning lights may illuminate in various combinations and colours.

When switching on drive-ready state, the functionality of some lights is checked and they illuminate briefly.

Red lights

Seat belt warning



Seat belt is not buckled.

For further information:

Seat belt warning, see page [112](#).

Airbag system



Warning light is illuminated briefly: this indicates that the entire airbag system and seat belt tensioners are operational when the vehicle is switched on.

Warning light does not illuminate or illuminates continuously: The airbag system or belt tensioners may not be functioning. Have the vehicle checked immediately by an authorised Service Partner or another qualified Service Partner or a specialist workshop.

For further information:

Airbags, see page [184](#).

Parking brake



The parking brake is engaged.

For further information:

Parking brake, see page [144](#).

Brake system



The brake linings are worn or there is a fault in the brake system.

The braking force assistance may be not functional. A higher pedal force may be required during braking.

Have the vehicle checked immediately by an authorised Service Partner or another qualified Service Partner or a specialist workshop.

Emergency Stop Assistant



The Emergency Stop Assistant is triggered.

For further information:

Emergency Stop Assistant, see page [213](#).

Risk of collision



Warning light is illuminated or flashes in conjunction with an acoustic signal if a collision is imminent.

For further information:

Front collision warning, see page [190](#).

Pedestrian warning



Warning light illuminates: risk of collision with a person, e.g., pedestrian or cyclist, has been detected. Increased awareness is required.

Warning light flashes and signal sounds: risk of impending collision with a person, e.g., pedestrian or cyclist, has been detected. Immediately start braking or an avoidance manoeuvre.

For further information:

Warning function for pedestrians, see page [195](#).

Collision Warning



Warning light illuminates: risk of collision, e.g., with a vehicle, has been detected. Increased awareness is required.

Warning light flashes and signal sounds: risk of impending collision with a vehicle has been detected. Immediately start braking or an avoidance manoeuvre.

For further information:

Warning function in the rear collision situation, see page [193](#).

Crossroads Warning: vehicle detected from the right



Warning light illuminates: risk of collision with a vehicle crossing from the right has been detected. Increased awareness is required.

Warning light flashes and signal sounds: risk of impending collision with a crossing vehicle has been detected. Immediately start braking or an avoidance manoeuvre.

For further information:

Warning function at road junctions, see page [197](#).

Crossroads Warning: vehicle detected from left



Warning light illuminates: risk of collision with a vehicle crossing from the left has been detected. Increased awareness is required.

Warning light flashes and signal sounds: risk of impending collision with a crossing vehicle has been detected. Immediately start braking or an avoidance manoeuvre.

For further information:

Warning function at road junctions, see page 197.

Distance control



Warning light flashes and an acoustic signal sounds: brake and perform avoidance manoeuvre, if necessary.

For further information:

Distance control, see page 237.

Assisted Driving Mode



The warning light flashes and a signal sounds:

The system is switching off or an interruption of the system is imminent.

The warning light is illuminated and a signal sounds:

The driver's line of vision is not directed towards the traffic situation. A system interruption is imminent. The system reduces the speed to a standstill if applicable. The system may possibly not perform any supporting steering wheel movements.

For further information:

Assisted Driving Mode, see page 243.

Assisted Driving Mode: hands not on the steering wheel



The warning light is illuminated and a signal sounds:

Hands are not gripping the steering wheel or, depending on vehicle equipment and national-market version, the driver is not looking toward traffic. A system interruption is imminent.

The system reduces the speed to a standstill if applicable.

The system may possibly not perform any supporting steering wheel movements.

Immediately place both hands on the steering wheel and pay attention to the traffic situation.

For further information:

Assisted Driving Mode, see page 243.

Yellow lights

Anti-lock Braking System



There is a malfunction or the system is faulty. The Anti-lock Braking System (ABS) is not available.

Ease of steering may be restricted during full braking.

Have the vehicle checked immediately by an authorised Service Partner or another qualified Service Partner or a specialist workshop.

For further information:

Anti-lock Braking System (ABS), see page 223.

Brake system



The brake linings are worn or there is a fault in the brake system.

Have the vehicle checked by an authorised Service Partner or another qualified Service Partner or a specialist workshop.

Assisted Driving Mode



The warning light is illuminated and a signal sounds: a system interruption is imminent.

The warning light flashes: a lane boundary has been crossed.

For further information:

Assisted Driving Mode, see page 243.

Assisted Driving Mode: hands not on the steering wheel



Hands are not holding the steering wheel. System remains active.

Grab the steering wheel with your hands.

For further information:

Assisted Driving Mode, see page [243](#).

Front collision warning restricted or failed



Depending on the equipment and national-market version: functional limitation detected, for example due to system limitations of the camera or system failure. It is possible to continue driving. Where applicable, observe the information from Check Control messages.

For further information:

Front collision warning, see page [190](#).

Dynamic Stability Control



Warning light pulsates: Dynamic Stability Control is regulating the drive and brake forces. The vehicle is being stabilised. Reduce speed and adjust the driving style to the road conditions.

Warning light is illuminated: Dynamic Stability Control has failed or is initialising. The driving stabilisation is restricted or has failed.

If the warning light is continuously illuminated, have the vehicle checked immediately by an authorised Service Partner or another qualified Service Partner or a specialist workshop.

For further information:

Dynamic Stability Control, see page [223](#).

Dynamic Stability Control deactivated or increased driving dynamics activated



Dynamic Stability Control is deactivated or increased driving dynamics is activated.

For further information:

- ▷ Dynamic Stability Control, see page [223](#).
- ▷ Setting for increased driving dynamics, see page [224](#).

Flat tyre monitor



The warning light illuminates: flat tyre or a tyre pressure loss has been detected.

Reduce your speed and carefully stop the vehicle. Avoid heavy braking and sudden steering manoeuvres.

For further information:

Flat Tyre Monitor, see page [364](#).

Tyre Pressure Monitor



The warning light illuminates: flat tyre or a tyre pressure loss has been detected. Note the information in the Check Control message.

Warning light pulses.

Warning light flashes and is then illuminated continuously: the system is unable to detect flat tyres or tyre pressure losses.

- ▷ Fault due to systems or devices with the same radio frequency: the system is automatically reactivated upon leaving the field of interference.
- ▷ For tyres with special approval: the Tyre Pressure Monitor was unable to complete the reset. Reset the system again.
- ▷ Wheel without wheel electronics is fitted: if necessary have it checked by an authorised

Service Partner or another qualified Service Partner or a specialist workshop.

- ▶ Malfunction: have the system checked by an authorised Service Partner or another qualified Service Partner or a specialist workshop.

For further information:

Tyre Pressure Monitor, see page 358.

Steering system



The steering system may be faulty.

Have the system checked by an authorised Service Partner or another qualified Service Partner or a specialist workshop.

Engine warning light



▶ When the warning light flashes:

There is an engine fault which could damage the catalytic converter.

Have the vehicle checked immediately.

▶ When warning light illuminates:

Emission levels have deteriorated.

Have the vehicle checked as soon as possible.

Have the vehicle checked by an authorised Service Partner or another qualified Service Partner or a specialist workshop.

Lane Departure Warning



Depending on equipment and national-market version:

Warning light is illuminated: functional limitation detected, for example, due to low sun or system failure. It is possible to continue driving. Where applicable, observe the information from Check Control messages.

Warning light flashes: a warning is issued actively. The system does not carry out any steering interventions.

For further information:

Lane Departure Warning, see page 200.

Rear fog light



Rear fog light is switched on.

For further information:

Rear fog light, see page 177.

Acoustic protection for pedestrians



Acoustic protection for pedestrians has failed. Increased caution when manoeuvring.

In case of repeated malfunctions, have the system checked by an authorised Service Partner or another qualified Service Partner or a specialist workshop.

For further information:

Acoustic protection for pedestrians, see page 133

Green lights

Turn indicators



The turn indicator is switched on.

If the indicator light flashes more rapidly than usual, a turn indicator bulb has failed.

For further information:

Turn indicators, see page 170.

Side lights



The side lights are switched on.

For further information:

Side light, low-beam headlight, see page 173.

Low-beam headlight



The low-beam headlight is switched on.

For further information:

Side light, low-beam headlight, see page [173](#).

High-beam Assistant



Low-beam headlight is switched on and the High-beam Assistant is activated.

The high-beam headlight is switched on and off automatically according to traffic situation.

For further information:

High-beam Assistant, see page [171](#).

Lane Departure Warning



Depending on equipment and national-market version:

Indicator light flashes: the system actively issues a warning. If necessary, the system performs a steering intervention.

For further information:

Lane Departure Warning, see page [200](#).

Automatic Hold: vehicle is held automatically



Automatic Hold is ready to operate.

The vehicle is held automatically when at a standstill.

For further information:

Automatic Hold, see page [146](#).

Automatic Hold: vehicle secured against rolling away



The vehicle is automatically secured against rolling away after stopping.

For further information:

Automatic Hold, see page [146](#).

Manual Speed Limiter



Indicator light illuminates: the system is switched on.

Indicator light flashes: set speed limit is exceeded.

For further information:

Manual Speed Limiter, see page [233](#).

Cruise Control



The system is active.

For further information:

Cruise Control, see page [235](#).

Distance control



Indicator light illuminates: system has detected a vehicle ahead. The vehicle symbol goes out if no vehicle in front is detected.

Indicator light flashing: vehicle in front has driven off.

For further information:

Distance control, see page [237](#).

Speed Limit Assist



The detected speed limit can be applied with the SET button. As soon as the speed limit has been adopted, a green tick is displayed.

For further information:

Speed Limit Assist, see page [253](#).

Assisted Driving Mode



The system is helping the driver keep the vehicle in the driving lane.

For further information:

Assisted Driving Mode, see page [243](#).

Lane Change Assistant: lane change in progress

 Green arrow symbol for lane-changing: the system is carrying out a lane change.

For further information:

Lane Change Assistant, see page [248](#).

Lane Change Assistant Lane: lane change not possible

 Grey line for lane boundary on the appropriate side: the system has detected the lane change request. Lane change not currently possible.

For further information:

Lane Change Assistant, see page [248](#).

Assisted Driving Mode Plus

 The system is active.

For further information:

Assisted Driving Mode Plus, see page [250](#).

Blue lights

High-beam headlight

 The high-beam headlight has been switched on.

For further information:

High-beam headlight, see page [170](#).

Grey lights

Distance control

 Indicator light flashes: the requirements for operation of the system are no longer being met. The system has been deactivated but will continue to brake until you

actively take over by depressing the brake or accelerator pedal.

For further information:

Distance control, see page [237](#).

Assisted Driving Mode

 System is on standby and does not make any steering wheel movement.

The system activates automatically when all operating requirements are met.

For further information:

Assisted Driving Mode, see page [243](#).

Assisted Driving Mode Plus

 The system is interrupted and activates automatically as soon as all functional requirements are met.

For further information:

Assisted Driving Mode Plus, see page [250](#).

Front collision warning

 Depending on vehicle equipment and national-market version: the system is switched off.

For further information:

Front collision warning, see page [190](#).

Lane Departure Warning

 Depending on equipment and national-market version:

Warning light is illuminated: the system is switched off or automatically deactivated, for example, because DSC OFF is activated.

Warning light flashes: a warning is issued actively. The system does not carry out any steering interventions.

For further information:

Lane Departure Warning, see page [200](#).

White lights

Cruise Control with distance control



No display of distance control as the accelerator pedal is being pressed.

For further information:

Distance control, see page [237](#).

Assisted Driving Mode Plus



The system can be activated.

For further information:

Assisted Driving Mode Plus, see page [250](#).

Selection lists

Principle



The instrument cluster or the Head-up display can show lists for certain functions and can be used for operation where applicable.

- ▷ Entertainment source.
- ▷ Current audio source.
- ▷ Recent calls list.

If applicable, the relevant menu is opened on the control display.

Displaying and using the list

The selection lists can be displayed and operated using the operating elements on the steering wheel.

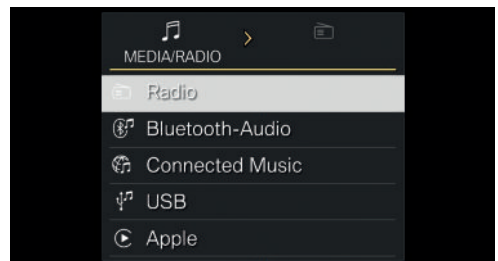

Operating elements	Function
	Changing the entertainment source. Press the button again to close the list currently displayed.
	To display the last calls list.
	Turn the knurled wheel: display the list of the currently selected entertainment source or scroll up or down in the list. Tilt the knurled wheel in the corresponding direction: move the selection to the left or right. Press the knurled wheel: confirm the selection.

Display





The selection lists, for example, entertainment sources, are displayed in the instrument cluster.

Example: selecting a radio station

1.  Press the button for entertainment sources.
2.  To switch to the list of radio stations, tilt the knurled wheel to the right.

3. Turn the knurled wheel to select a radio station.
4. Press the knurled wheel to confirm the selected radio station.

Example: changing the entertainment source

1.  Press the button for entertainment sources.
2.  Turn the knurled wheel to select an entertainment source.
3. Press the knurled wheel to confirm the selected entertainment source.

Optimum shift indicator

Principle

The optimum shift indicator recommends the gear that best suits the current driving situation. The use of the optimal gear supports an efficient driving style.

General





Depending on the equipment and the national-market version, the optimum shift indicator is active in manual mode M.

Displays

Information on upshifting, downshifting or the engaged gear is displayed in the instrument cluster.

For vehicles without optimum shift indicator, the gear engaged is shown.

Example Description

	In permanent manual mode M: Optimal gear is engaged.
	With shift paddles: temporary manual mode.
	With shift paddles: Sport programme.
	Switching instruction.

For further information:
Shift paddles, see page 138

Power display

Principle

The power display indicates the currently drawn drive power as a percentage.

Activating/deactivating power display

Depending on the selected drive mode or the individually configured layout, the power display or revolution counter is displayed.

Display





Needle in the arrow 1 area: display of the energy recuperation achieved, for example during deceleration, CHARGE.

Needle in the area of arrow 2: drive power as a percentage, POWER.

Reduced drive power

The available drive power may be reduced due to certain factors. The power display is automatically adjusted as necessary.

In addition, icons on the power display and in the revolution counter indicate if the drive power has been reduced.

Icon	Description
	Blue icon: cold drive system. White icon: increased drive system temperature, for example due to long-lasting or high power requirements when driving uphill.
	Depending on equipment and national-market version: Restriction of drive power set by BMW Digital Key.
	System-related functional limitation. A Check Control message will be shown as necessary.

Revolution counter

General

It is vital to avoid rotational speeds in the red warning zone. In this zone, the fuel supply is interrupted to protect the engine.

Activating/deactivating the revolution counter

The revolution counter is displayed depending on the selected drive mode or the individually configured layout.

The display of the revolution counter is variable and depends on the selected drive mode.

Reduced speed range

The available speed range may be reduced due certain factors, example a cold drivetrain. The revolution counter display is automatically adjusted depending on the available speed range.

Standby state and drive-ready state



OFF is shown in the instrument cluster. The drive-ready state is switched off and standby state switched on.



READY is shown in the instrument cluster. The Automatic Start/Stop function is ready for an automatic engine start.

For further information:

- ▶ Vehicle operating condition, see page 47.
- ▶ Automatic Start/Stop function, see page 133.

Engine temperature



- ▶ Cold engine: the needle is in the blue temperature range, close to the limit position of the temperature display and the WARM-UP text is displayed.



Drive at moderate rotational speed and vehicle speed.

- ▶ Normal operating temperature: the needle is located in the centre or left half of the temperature display.
- ▶ Hot engine: the needle is in the red temperature range. A Check Control message is also displayed.

For further information:

Coolant level, see page 383.

Outside temperature

General

If the display drops to +3 °C, 37 °F or lower, a signal sounds.

A Check Control message is shown.

There is an increased risk of black ice.

Safety information

WARNING

Even at temperatures above +3 °C, 37 °F there may be an increased risk of black ice, for example on bridges or on shaded sections of road. There is a risk of accident. At low temperatures, adjust driving style to the weather conditions.

Shift Lights

Principle

Shift Lights indicate the suitable upshift point at which fast acceleration values can be achieved.

General

The Shift Lights are active in manual mode M and can be displayed in the instrument cluster

or in the Head-up display in combination with the revolution counter.

Operating requirements

- ▶ Manual mode M must be activated.
- ▶ Advanced mode must be enabled.

For further information:

Advanced mode, see page 139.

Display



Yellow fields illuminate successively to indicate when a gearshift is due.

- ▶ Shift gear at the latest when all fields light up red.
- ▶ When the maximum engine speed is reached, the entire display flashes red and the fuel supply is limited to protect the engine.

Central display area

Displayable content

The following settings can be selected:

- ▶ Reduced view.
- ▶ Trip data, see page 163.
- ▶ Assisted View, see page 165.
- ▶ Route preview of the navigation system.
- ▶ Map view of the navigation system.
- ▶ G-Meter, see page 165.
- ▶ Entertainment.

▷ Augmented View.

Depending on the equipment, Augmented View in the instrument cluster enables the visualisation of driver assistance systems in the real vehicle environment.

Grey lines indicate the recommended minimum distance to the vehicle in front when Cruise Control is deactivated.

▷ Android Auto[®].

Depending on the equipment and national-market version, selected functions of a compatible smartphone can also be displayed, for example, map views.

Some contents for the central display area can also be configured as a view in the Head-up display.

For further information:

Head-up display, see page 150.

Owner's Handbook for Navigation, Entertainment and Communication, see page 6.

Configuring the central display area

The contents for the central indication range in the instrument cluster can be individually configured, for example, the display of trip data.



1. Press the button on the steering wheel.

A menu bar is displayed in the instrument cluster.

2. "CONTENT"

Select the menu by tilting the knurled wheel on the steering wheel as necessary.

3. Select the required setting using the knurled wheel on the steering wheel.

Trip data

Principle

The display of trip data provides various information about the trip, e.g. the average consumption or the trip distance.

General

The trip data can be shown on the control display and in the instrument cluster.





Journey data is shown on the control display depending on the settings in the Live Vehicle menu.

The values can be displayed and reset depending on different intervals.

Display on the control display

General

The following trip data is shown on the control display:

- ▷ Set interval for displaying the trip data.
- ▷  Average fuel consumption as a function of the set interval.
- ▷  Driving time depending on the set interval.
- ▷  Distance covered, depending on the set interval.
- ▷  The distance covered in the coasting drive state.

Displaying trip data continuously

1.  Apps menu
2. "Vehicle"
3. "Live Vehicle"
4. "Content"
5. "Journey data"

Display in the instrument cluster

Information on consumption and distance covered can be displayed on the instrument cluster.

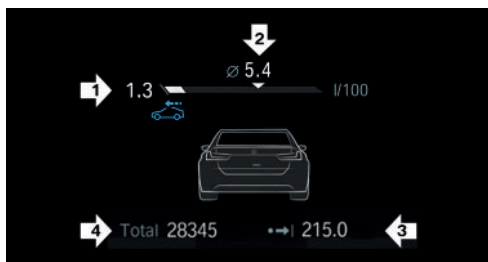

- ▷ Current consumption, arrow 1.
- ▷ Average consumption, arrow 2.
- ▷ Distance covered depending on the configured interval, arrow 3.
 -  This icon is displayed when the vehicle is in coasting driving condition.
- ▷ Total kilometres, arrow 4.

Current consumption

The display of the current consumption allows you to check the current fuel consumption, e.g. for driving economically and in an environmentally friendly manner.

Average consumption

The average fuel consumption is displayed depending on the setting of the intervals for displaying the trip data.

Configuring the trip data display

The intervals for displaying the trip data in the instrument cluster and on the control display can be configured.

1.  Apps menu
2. "Vehicle"
3. "System settings"
4. "Time period for journey data"

5. "Values"
6. Select the desired setting:
 - ▷ "Since start of journey ()": the values are reset automatically if the vehicle is at a standstill for approximately four hours.
 - ▷ "Since last refuel ()": the values are reset automatically after refuelling with a significant amount of fuel.
 - ▷ "Since factory": the values since leaving the factory are displayed.
 - ▷ "Since Individual ()": the values since the last manual reset are displayed. The values can be reset at any time.

Resetting average values manually

The following interval can be reset manually at any time:

"Since Individual ()"

Using the knurled wheel on the steering wheel:

1. Display trip data in the instrument cluster.
2. Press and hold the knurled wheel



on the steering wheel until the values are reset.

Via iDrive:

1.  Apps menu
2. "Vehicle"
3. "System settings"
4. "Time period for journey data"
5. "Reset Individual"

The average values and counters are reset. Once the average values and counters have been reset, the following interval is automatically activated:

"Since Individual ()"

Assisted View

Principle

With Assisted View, information on driver assistance systems can be displayed on the instrument cluster with a vehicle animation.

Information on parking and manoeuvring is displayed in Assisted View whenever Park Assist is enabled.

Safety information

WARNING

The system does not relieve you of your personal responsibility to assess the traffic situation correctly. Due to system limits, it cannot respond independently and appropriately in all traffic situations. There is a risk of accident. Adapt your driving style to the traffic conditions. Observe the traffic situation, be ready to take over steering and braking at any time, and actively intervene if the situation warrants it.

General

The Assisted View display can be configured in the central indication range and displayed.

For further information:

Central display area, see page [162](#).

Display

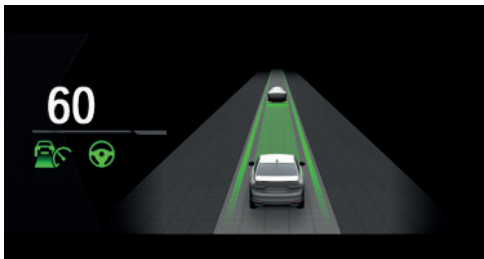

An example when driver assistance is active: the indicator and warning lights for Distance Control and Assisted Driving Mode are displayed. At the same time, distance control is animated in the Assisted View.

System limits

The detection capability of the system is limited.

Only objects detected by the system are taken into account.

For further information:

- ▷ Cameras, see page [42](#).
- ▷ Radar sensors, see page [43](#).

G-Meter

General

The G-Meter shows the longitudinal and lateral forces acting on the vehicle occupants during a journey.

The display can be configured in the central indication range of the instrument cluster.

The values are automatically reset after each start of the journey.

For further information:

Central display area, see page [162](#).

Manually resetting G-Meter values

1. Display G-Meter in the instrument cluster.
2. Press and hold the knurled wheel



on the steering wheel until the values are reset.

Date and time

Various settings can be configured for the display of date and time, for example the date format.

Depending on the equipment and national-market version, the time zone can be set and the automatic time setting can be activated. The automatic time setting automatically updates the time, date and, if necessary, the time zone.

1.  Apps menu
2. "Vehicle"
3. "System settings"
4. "Date and time"
5. Select the desired settings.

Fuel level indicator

Principle

The current filling level of the fuel tank is displayed.

General

The vehicle inclination may cause the display to fluctuate.

For further information:

Refuelling, see page 346.

Display



An arrow next to the fuel pump symbol indicates on which side of the vehicle the fuel filler flap is located.

The current range is displayed as a numerical value.

Range

Principle

The range shows what distance can be covered with the amount of fuel currently in the tank.

General

The estimated range available with the remaining fuel is displayed in the instrument cluster.

A Check Control message is displayed briefly if the remaining range is low. A small remaining range means that the engine functions are not always ensured if a sporty driving style is employed, e.g. when cornering fast.

If the range drops below approximately 50 km, 30 miles the Check Control message is displayed continuously.

Safety information

NOTICE

If the range drops below 50 km, approx. 30 miles, the engine may no longer be supplied with sufficient fuel. The engine functions are no longer ensured. There is a risk of material damage. Refuel in good time.

Display



The current range is displayed as a numerical value on the fuel level indicator.

Selecting the units of measurement

Depending on the national-market version, it is possible to select the units of measurement for various values, for example, consumption, distances and temperature.

1.  Apps menu
2. "Vehicle"
3. "System settings"

4. "Units"
5. Select the desired setting.

Vehicle status







General

The status can be displayed and actions performed for several systems, such as for Check Control.

Displaying the vehicle status

1.  Apps menu
2. "Vehicle"
3. "Vehicle status"

Overview

Icon	Description
	"FLAT TYRE MONITOR": Status of the Flat Tyre Monitor, see page 364 .
	"Tyre Pressure Monitor": status of the Tyre Pressure Monitor, see page 358 .
	"Engine oil level": Electronic oil measurement, see page 380 .
	"AdBlue": BMW Diesel with BluePerformance, see page 376 .
	"Check Control": to display saved Check Control messages, see page 151 .
	"Service requirements": Service notification display, see page 168 .

Current driving condition

General

The current driving condition is displayed dynamically while driving in the Live Vehicle menu on the control display.

The following states can be displayed:

- ▷ Driving.
- ▷ Coasting driving condition: "EFFICIENT COASTING".
- ▷ "CHARGING BATTERY"

With mild hybrid technology:

- ▷ Adaptive recuperation.
Depending on the situation, additional information on adaptive recuperation may be displayed.
- ▷ Efficient coasting with the engine switched off.

For further information:

- ▷ Adaptive recuperation, see page [340](#).
- ▷ Coasting, see page [341](#).

Operating requirements

- ▷ Personal Mode or Efficient Mode is selected as the drive mode.
- ▷ The following setting is selected for Live Vehicle: "Adaptive content"

Display

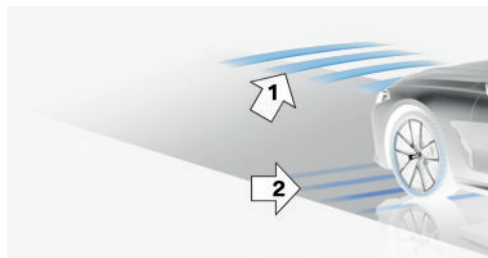

An example:

The adaptive recuperation is active, arrow 1.



The vehicle battery is charged when the vehicle is decelerating, arrow 2.

Sport displays

Principle

The sport displays primarily assist a sporty driving style.

Operating requirements

- ▷ Sport Mode is selected.
- ▷ When using Live Vehicle, the following setting is selected: "Adaptive content"

Display

The sport displays are displayed in the Live Vehicle menu on the control display.

The following information is displayed:

- ▷ Torque.
- ▷ Power.
- ▷ Charging pressure.
- ▷ Engine oil temperature.

Service notification

Principle

Service notifications indicate necessary maintenance.

General

After switching on, the next service appointment or the distance remaining until your next servicing is displayed briefly on the instrument cluster if necessary.

A service advisor will be able to read out the scope of maintenance work from the vehicle key.

Display

Detailed information on necessary maintenance can be shown on the control display.

1. Apps menu
2. "Vehicle"
3. "Vehicle status"
4. "Service requirements"
Necessary maintenance measures and any statutory inspections are displayed.
5. Select the desired entry.

Entering deadlines

Dates for mandatory vehicle inspections can be entered.

Ensure that the date and time are set correctly in the vehicle.

1. Apps menu
2. "Vehicle"
3. "Vehicle status"
4. "Service requirements"
5. "Vehicle inspection"
6. "Date:"
7. Select the desired setting.

Service history

Principle

Completed maintenance work can be displayed on the control display.

General



Have maintenance work carried out by an authorised Service Partner or another qualified Service Partner or a specialist workshop. The maintenance work carried out is entered in the vehicle data. The function is available as soon as a maintenance visit has been logged in the vehicle data.



Displays

1.  Apps menu
2. "Vehicle"
3. "Vehicle status"
4. "Service requirements"
Necessary maintenance measures and any statutory inspections are displayed.
5. "Service history"
6. Select an entry to display more detailed information.

Icons

Icon	Description
	Maintenance has been carried out on time.
	Maintenance has been carried out later than scheduled.
	Maintenance has not been carried out.

Light and vision

Vehicle equipment

This chapter describes equipment, systems and functions which are offered or may be offered in future on a model-specific basis, even if they are not included in the vehicle in question.

For further information:

Vehicle equipment, see page 8.

Turn indicators

Turn indicator in exterior mirror

To ensure that the indicator lamps in the exterior mirrors can be seen, do not fold in the exterior mirrors while driving and while the turn indicators or hazard warning lights are operating.

Indicating

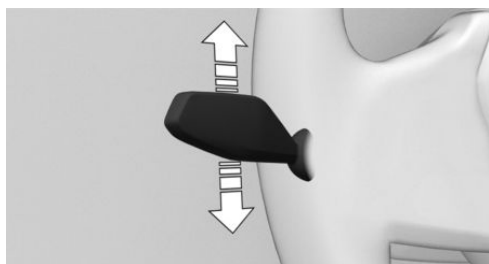

Press the lever beyond the resistance point.

One-touch signalling

Briefly tap the lever up or down.

The duration of the one-touch signalling can be set.

1.  Apps menu
2. "Vehicle"

3. "Exterior lighting"
4. If necessary, "Additional settings"
5. "One-touch indicator"
6. Select the desired setting.

Indicating a turn briefly

Press the lever as far as the resistance point and hold it there for as long as you wish to indicate a turn.

High-beam headlight, headlight flasher

Press the lever forwards or pull it back.



- ▷ High-beam headlight on, arrow 1.
The high-beam headlight is illuminated when the low-beam headlight is switched on.
- ▷ High-beam headlight off/headlight flasher, arrow 2.



The indicator light in the instrument cluster is illuminated when the high-beam headlight is switched on.

High-beam Assistant

Principle

High-beam Assistant detects other road users in good time and activates or deactivates the high-beam according to traffic situation.

General

High-beam Assistant ensures that the high-beam headlight is switched on when the traffic situation allows. The system does not switch on the high-beam headlight at low speed range.

The system responds to the lights of oncoming traffic and traffic driving ahead of you, and to ambient lighting, for example in built-up areas. The high-beam headlight can be switched on and off manually at any time.

If equipped with Selective Beam, the high-beam headlight is not switched off for oncoming vehicles or vehicles driving ahead of you. Instead, the system masks only those areas of the beam which would otherwise dazzle oncoming traffic or traffic driving ahead. In this case, the blue indicator light continues to illuminate.

Depending on the equipment: if the headlights have been converted, High-beam Assistant may only function to a restricted extent.

For further information:

Left-hand/right-hand traffic, see page [177](#).

Operating requirements

- ▷ Automatic driving lights control is activated.
- ▷ The low-beam headlight is switched on.

Activating High-beam Assistant

1.  Apps menu
2. "Vehicle"
3. "Exterior lighting"

4. "Additional settings"
5. "Main beam assistant"



The indicator light in the instrument cluster is illuminated when the low-beam headlight is switched on.

The system will switch automatically between low-beam headlight and high-beam headlight.



The blue indicator light in the instrument cluster illuminates if the high-beam headlight is switched on by the system.

If a journey is interrupted with High-beam Assistant activated: when the journey is resumed, High-beam Assistant remains activated.

The High-beam Assistant is deactivated by switching the high-beams on and off manually.



To reactivate High-beam Assistant, press the turn indicator lever forwards, arrow 1.

Deactivating High-beam Assistant



Press the turn indicator lever forwards, arrow 1, or pull the turn indicator lever backwards if the high-beam headlight is switched on, arrow 2.

If the High-beam Assistant is deactivated via iDrive, operation via the turn indicator lever is not possible.

System limits

High-beam Assistant cannot replace the driver's own judgement as to when to use the high-beam headlight. Therefore activate the dipped headlights manually if the situation requires it.

In the following situations, the system will not operate or its operation will be restricted and your intervention may be required:

- ▶ In extremely adverse weather conditions such as fog or heavy precipitation.
- ▶ When detecting poorly lit road users such as pedestrians, cyclists, horse riders or carriages and when trains or ships are close to the road, or when animals are crossing the road.
- ▶ On tight bends, on steep brows or hollows of hills, when there is crossing traffic or if the view of oncoming vehicles on a motorway is partly obstructed.
- ▶ In poorly lit towns or where there are highly reflective signs.
- ▶ If the area of windscreen in front of the interior mirror is covered with condensation, dirt, stickers, labels, etc.

Exterior lights

Overview

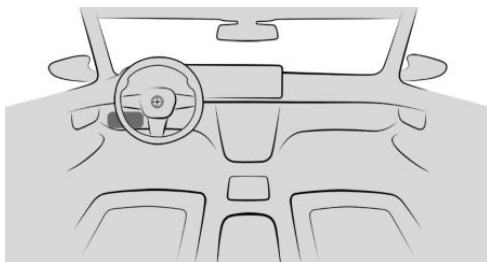

Buttons in the vehicle





Icon	Function
	Exterior lights menu.
	Automatic driving lights control.
	Low-beam headlight.
	Exterior lights off.
	Rear fog light.

Functions via iDrive

Icon	Function
	Automatic driving lights control.
	Low-beam headlight.
	Side lights.
	Exterior lights off.

Icon	Function
	Parking light, left.
	Parking light, right.

Buttons on the vehicle key

Icon	Function
	Interior lighting. Parts of the exterior lights.
	Home lights.

Automatic driving lights control

Principle

Depending on ambient brightness, the system switches the low-beam headlight on or off automatically, for example in a tunnel, at twilight and in rain or snow.

General

The headlights may also be switched on when the sun is low against a blue sky.

If the low-beam headlight is switched on manually, the automatic driving lights control is deactivated.

Activating the automatic driving lights control

 Press the button on the light switch.

The symbol in the button lights up green.



The indicator light in the instrument cluster is illuminated when the low-beam headlight is switched on.

System limits

The automatic driving lights control is no substitute for using your own judgement to assess the light conditions.

The sensors are unable to recognise fog or hazy weather, for example. In such situations, switch on the lights manually.

Side lights, low-beam headlights, and parking lights

General

If the driver's door is opened when drive-ready state is switched off, the exterior lights are switched off automatically after a given time.

Side lights

General

The side lights can only be switched on in the low speed range.

Switching on the side lights

-  Apps menu
- "Vehicle"
- "Exterior lighting"
- "Side light"



The indicator light in the instrument cluster is illuminated.

The vehicle is illuminated all round.

Do not leave the side lights on for extended periods of time, as this could drain the vehicle battery and it may no longer be possible to switch on drive-ready state.



Switching off the side lights

The side lights can be switched off as follows:

- ▶ Press and hold the  button on the light switch.
- ▶ Switch off the lights via iDrive.
- ▶ Switch on drive-ready state.
After switching on drive-ready state, the automatic driving lights control is activated.

Low-beam headlight

Switching on the low-beam headlight

Press the button on the light switch.



The low-beam headlight illuminates if drive-ready state is switched on.

The indicator light in the instrument cluster is illuminated.



To switch on the low-beam headlight as soon as the standby state is switched on, press the button again.

Switching off the low-beam headlight

Depending on the national-market version, the low-beam headlight may be switched off in the low speed range:

- ▶ Press and hold the  button on the light switch.
- ▶ Switch off the lights via iDrive.

Parking light

When parking the vehicle, it is possible to switch on a parking light on one side.

1.  Apps menu
2. "Vehicle"

3. "Exterior lighting"
4. "Left parking light" or "Right parking light"

Welcome light

Principle

With the welcome light, the exterior lights are automatically turned on for a limited time when approaching or unlocking the vehicle.

General

Depending on the equipment, the exterior lights of the vehicle can be individually adjusted.

Activating/deactivating welcome light

1.  Apps menu
2. "Vehicle"
3. "Exterior lighting"
4. If necessary, "Additional settings"
5. Depending on the equipment, select the desired setting:
 - ▶ "Welcome and goodbye"
When unlocking the vehicle, individual lighting functions are turned on.
 - ▶ "BMW Iconic Glow"
The radiator grille lighting settings are only available while at a standstill and with drive-ready state switched off.

Turning on the welcome light

- ▶ Automatically on approach.
- ▶ During unlocking.



- ▶  With the vehicle locked, press the button on the vehicle key.

Depending on the settings, the interior lighting and parts of the exterior lighting will be turned on.

The function is not available for the first 10 seconds after locking.

Welcome Light Carpet

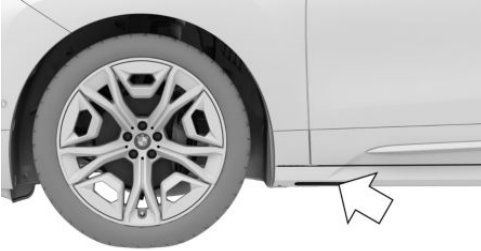

The light source is located in the position indicated.

Keep the light source clean and unobstructed.

Home lights

Principle

With the home lights, the exterior lights are automatically turned on for a limited time after leaving the vehicle in order to illuminate the area around the vehicle.

Switching on the home lights

- ▶ After switching off drive-ready state, press the turn indicator lever forwards briefly.

- ▶  Press and hold the button on the vehicle key for approximately 1 second.

Activate the home lights function for the button of the vehicle key:

1.  Apps menu
2. "Vehicle"
3. "Doors and windows"

4. "Vehicle key"
5. Select the desired setting.

Setting the duration

1.  Apps menu
2. "Vehicle"
3. "Exterior lighting"
4. If necessary, "Additional settings"
5. "Home lights"
6. Select the desired setting.

Daytime driving lights

General

The daytime driving lights illuminate when drive-ready state is switched on.



The indicator light in the instrument cluster is illuminated when the rear daytime driving lights are switched on.

Activating/deactivating daytime driving lights

In some countries, daytime driving lights are compulsory, in which case the daytime driving lights cannot be deactivated at the front.

1.  Apps menu
2. "Vehicle"
3. "Exterior lighting"
4. If necessary, "Additional settings"
5. Depending on equipment or national-market version:
 - ▶ "Daytime driving lights"
 - ▶ "Rear daytime driving lights"
 - ▶ "BMW Iconic Glow"





Dynamic ECO light function

General

In the low speed range, the brightness of the low-beam headlights is reduced.

Activating the dynamic ECO light function

-  If necessary, press the button on the light switch to activate the automatic driving lights.
The LED in the button illuminates.
-  Press the button.
- "EFFICIENT"
- If necessary, "Settings"
- If necessary, "Efficient visibility functions"

Adaptive lighting functions

Principle

Adaptive lighting functions makes it possible to illuminate the road responsively.

General

The adaptive lighting functions consist of one system or multiple systems, depending on the equipment:

- ▷ Adaptive Headlights.
- ▷ Variable light distribution.
- ▷ Cornering light.
- ▷ Roundabout light.

Activating the adaptive light functions

Press the button on the light switch.



The LED in the button illuminates.

The adaptive lighting functions are active when drive-ready state is switched on.

Adaptive Headlights

General

The high-beam headlight follows the road ahead in response to the steering wheel angle and other parameters.

Anticipatory Adaptive Headlights

The high-beam headlight is adapted to the direction of travel ahead even before entering or leaving a bend.

S-bend lights

The high-beam headlight is kept as straight as possible when driving around S-bends.

Variable light distribution

Principle

The variable light distribution enables better illumination of the road.

General

The light distribution is adjusted automatically depending on speed and navigation data, if necessary.

Urban lights

The light beam from the low-beam headlight is extended at the sides.

Motorway beam pattern

The range of the low-beam headlight is increased.

Cornering light

Principle

When turning off or on tight bends, for example hairpin bends, up to a certain speed, a cornering light is added to illuminate the inside area of the bend.

General

The cornering light is switched on automatically depending on the steering wheel angle or, where applicable, activation of the turn indicators.

When reversing, the cornering light is activated automatically irrespective of the steering wheel angle.

Hairpin lights

The cornering light is also switched on before entering hairpin bends.

Roundabout light

Shortly before driving onto a roundabout, the cornering light is activated on both sides. The edge of the road is illuminated more effectively. Shortly before leaving a roundabout, the cornering light is switched off again on both sides.

Adaptive headlight range control

Adaptive headlight range control compensates for acceleration and braking manoeuvres and vehicle load conditions to prevent oncoming vehicles from being dazzled.

Fog light

Rear fog light

Operating requirements

The low-beam headlight must be switched on before the rear fog light can be activated.

Switching the rear fog light on/off



Press the key.



The yellow indicator light in the instrument cluster illuminates when the rear fog light is switched on.

If automatic driving lights control has been activated, the low-beam headlight switches on automatically when the rear fog light is switched on.

Bad weather light

Principle

The bad weather light provides optimised illumination of the road when visibility conditions are poor, for example in fog or rain. The light distribution from the low-beam headlight is adapted to the visibility conditions.

Activating/deactivating the bad weather light

The bad weather light is activated when the automatic driving light system or the rear fog light is switched on.

Left-hand/right-hand traffic

General

When driving in countries where vehicles drive on the opposite side of the road to your vehi-

cle's country of registration, you will need to prevent the dazzling effect of your headlights.

Converting the headlights

1.  Apps menu
2. "Vehicle"
3. "Exterior lighting"
4. If necessary, "Additional settings"
5. "Right/left-hand traffic"
6. Select the desired setting.
Depending on the national-market version, the parking brake must be applied.

System limits

The availability of the High-beam Assistant might be restricted.

The availability of the adaptive lighting functions might be restricted.

Instrument lighting

Operating requirements

The brightness can only be adjusted in darkness and with turned on side light or low-beam headlight.

Adjusting the brightness

1.  Apps menu
2. "Vehicle"
3. "Interior lighting"
4. "Cockpit brightness at night"
5. Select the desired setting.

Interior lighting

General

Depending on the equipment, the interior lights, the footwell lights, door entry lighting,

ambient lighting and loudspeaker lighting are controlled automatically.

Overview

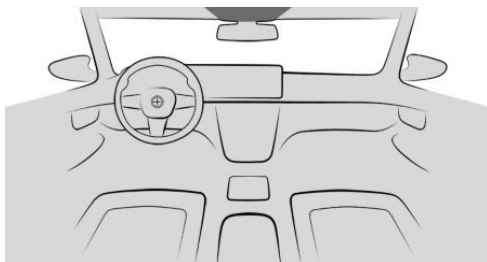

 Interior lighting menu

 Reading lights

 Interior lights

Switching interior lights on/off



Using the button:

 Press the key.

To switch off permanently: press and hold the button for approximately 3 seconds.

The interior lights in the rear can be switched on and off independently. The button is located on the headliner in the rear.

Via iDrive:

1.  Apps menu
2. "Vehicle"
3. "Interior lighting"
4. "Reading light"
5.  Tap the icon.

Switching reading lights on/off

Using the button:



Press the key.

Depending on the equipment, there are reading lights located at the front and in the rear beside the interior lights.

Via iDrive:

1.  Apps menu
2. "Vehicle"
3. "Interior lighting"
4. "Reading light"
5. Tap the desired seat.

The brightness can be adjusted when the reading lights are active.

Adjusting the settings

Depending on the equipment, the brightness can be individually adjusted for individual seats.

1.  Apps menu
2. "Vehicle"
3. "Interior lighting"
4. "Reading light"
5. Tap the desired seat.
6. Select the desired settings.

Ambient lighting

General

Depending on the equipment, the lighting for some of the interior lights can be adjusted.

Activating/deactivating ambient light

1.  Apps menu
2. "Vehicle"
3. "Interior lighting"
4. If necessary, "Ambience"
5. "Ambient lighting"

Turning ambient lighting on/off

The ambient lighting is switched on when the vehicle is unlocked and switched off when the vehicle is locked.

If the ambient lighting was deactivated using iDrive, it is not switched on when the vehicle is unlocked.

Selecting the colour

The colour of the ambient lighting can be selected only in Personal Mode.

1.  Apps menu
2. "Vehicle"
3. "Interior lighting"
4. If necessary, "Ambience"
5. "Colour"
6. Select the desired setting.

Adjusting the brightness

1.  Apps menu
2. "Vehicle"
3. "Interior lighting"
4. If necessary, "Ambience"
5. "Background light" or "Accent lighting"
6. Select the desired setting.

Dynamic light

Individual actions, for example incoming calls or detected obstacles when doors are open, are indicated by light effects. If the ambient light is deactivated, the light effects are still displayed.

1.  Apps menu
2. "Vehicle"
3. "Interior lighting"
4. If necessary, "Ambience"
5. "Lighting events"
6. Select the desired setting.

Reduced for journey at night

Some lights of the interior lighting are reduced when the vehicle is driven in the dark.

1.  Apps menu
2. "Vehicle"
3. "Interior lighting"
4. If necessary, "Ambience"
5. "Reduced for night driving"

Loudspeaker lighting

Principle

Some loudspeakers in the vehicle are illuminated.

General

When the loudspeakers are muted, the loudspeaker lighting turns off.

Turning loudspeaker lighting on/off

The loudspeaker lighting is switched on when the vehicle is unlocked and switched off when the vehicle is locked.

Wiper system

Safety information

WARNING

If the windscreen wipers start moving when they are folded away from the windscreen, parts of the body may become trapped or the vehicle may be damaged. There is a danger of injury or material damage. Make sure that the vehicle is switched off when the wipers are folded away from the windscreen, and that the windscreen wipers are in contact with the windscreen when switching on.

NOTICE

The wiper blades can wear out or become damaged prematurely when wiping on dry glass for longer periods of time. The wiper motor may overheat. There is a risk of material damage. Do not use the wipers when the glass is dry.

NOTICE

If the wipers are frozen to the windscreen, switching them on may cause the wiper blades to tear off and the wiper motor to overheat. There is a risk of material damage. Defrost the windscreen before switching on the windscreen wipers.

Switching on the wiper system

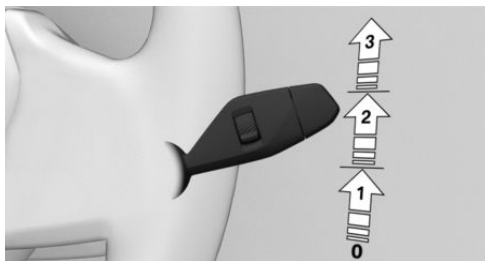

Press the lever upwards to the desired position.

- ▶ Rest position of the windscreen wipers, position 0.
- ▶ Rain sensor, position 1.
- ▶ Normal wiper speed, position 2.
When the vehicle is at a standstill, the wipers switch to intermittent operation.
- ▶ Fast wiper speed, position 3.
When the vehicle is at a standstill, the wipers switch to normal speed.

If a journey is interrupted with the wiper system switched on: when the journey is resumed,

the windscreen wipers continue operating at the previous level.

To protect the wiper motor from overheating, the wiper speed can be reduced in stages if necessary.

Switching off the wiper system and flick wiping

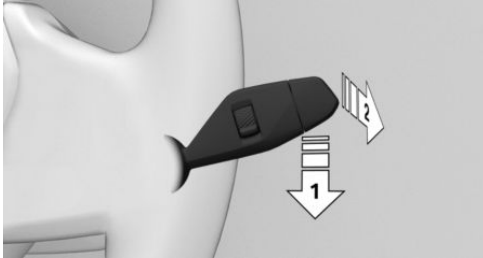

Press the lever downwards or forwards.

- ▶ To switch off: press lever downwards, arrow 1, until position 0 is reached.
- ▶ To flick wipe: press the lever downwards from position 0, arrow 1, and press the lever forwards from position 0 or position 1, arrow 2.

The lever returns to position 0 when released.

Rain sensor

Principle

The rain sensor automatically controls the wiper operation depending on the rain intensity.

General

The sensor is mounted on the windscreen, directly in front of the interior mirror.

Safety information

NOTICE

In car washes, the wipers may inadvertently start moving if the rain sensor is activated. There is a risk of material damage. Deactivate the rain sensor in car washes.

Activating the rain sensor

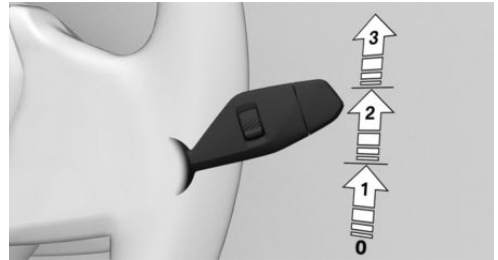

Press the lever upwards once from position 0, arrow 1.

Wiping is started.

The LED in the wiper lever is illuminated.

If there is frost, wiping may not start.

Deactivating the rain sensor

Press the lever back to position 0.

Adjusting the sensitivity of the rain sensor

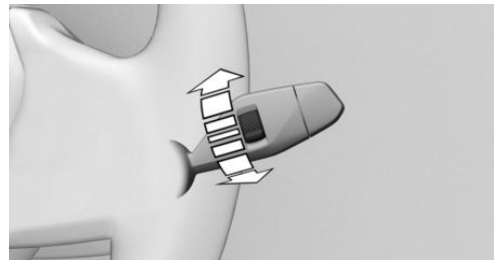

Turn the knurled wheel to adjust the sensitivity of the rain sensor.

- ▷ Upwards: high sensitivity of the rain sensor.
- ▷ Downwards: low sensitivity of the rain sensor.

Window washer system

Safety information

⚠ WARNING

At low temperatures, the washer fluid can freeze onto the windscreen and restrict visibility. There is a risk of accident. Only use the washer systems if there is no possibility of the washer fluid freezing. Use antifreeze additive if required.

⚠ NOTICE

If the washer fluid reservoir is empty, the washer pump cannot operate as intended. There is a risk of material damage. Do not use the washer system with the washer fluid reservoir empty.

Cleaning the windscreen

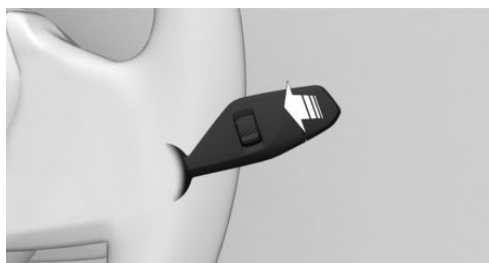

Pull the lever.

The washer fluid is sprayed onto the windscreen directly in front of the wiper blade as the wipers move up.

Windscreen wipers fold-out position

Principle

The wipers can be folded out from the windscreen in the fold-out position. This is necessary for example when replacing the wiper blades or to keep them away from the windscreen when there is frost.

Safety information

⚠ WARNING

If the windscreen wipers start moving when they are folded away from the windscreen, parts of the body may become trapped or the vehicle may be damaged. There is a danger of injury or material damage. Make sure that the vehicle is switched off when the wipers are folded away from the windscreen, and that the windscreen wipers are in contact with the windscreen when switching on.

⚠ NOTICE

If the wipers are frozen to the windscreen, switching them on may cause the wiper blades to tear off and the wiper motor to overheat. There is a risk of material damage. Defrost the windscreen before switching on the windscreen wipers.

Folding out the windscreen wipers

1. Switch on standby state.
2. Press the wiper lever down and hold until the windscreen wipers stop in an approximately vertical position.

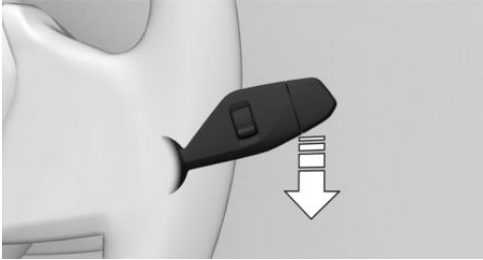

3. Lift the windscreen wipers completely away from the windscreen.



Folding down the windscreen wipers

1. Fold the windscreen wipers fully down onto the windscreen.
2. Switch on standby state and press and hold the wiper lever down again.

The windscreen wipers move back to the rest position and are operational once again.

Safety

Vehicle equipment

This chapter describes equipment, systems and functions which are offered or may be offered in future on a model-specific basis, even

if they are not included in the vehicle in question.

For further information:

Vehicle equipment, see page 8.

Airbags

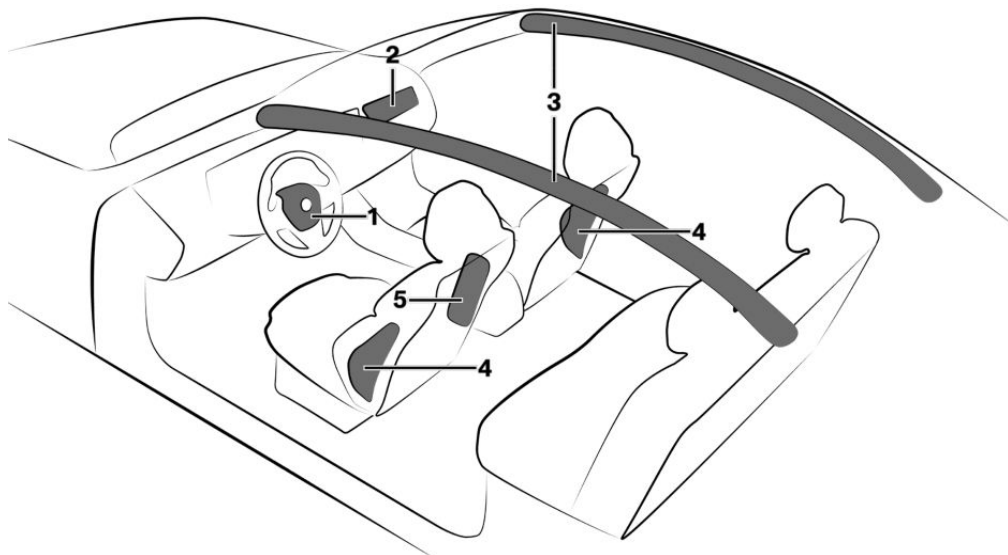

- 1 Front airbag, driver
- 2 Front airbag, front passenger
- 3 Head airbag
- 4 Side airbag
- 5 Centre airbag

Front airbags

Front airbags protect the driver and front passenger in the event of a head-on collision where the protection of the seat belts alone would no longer be sufficient.

Side airbag

In a side-on crash, the side airbag protects the side of the body in the chest and pelvic area.

Head airbag

The head airbag protects the head in the event of a side-on crash.

Centre airbag

Depending on the national-market version:

In case of a side collision, the centre airbag between the driver and front passenger additionally protects the head area.

Protective effect

General

Airbags are not activated in every collision situation, for example, in minor accidents.

Information for optimum airbag protective effect

WARNING

If a seat is in the wrong position, seat belts are not fastened correctly, or the airbag deployment zone is restricted, the airbag system will not be able to provide the intended level of protection and may cause additional injury when deployed. There is a danger of injury or danger to life. Observe the following for optimum protective effect of the airbag system.

- ▶ Keep a distance from the airbags.
- ▶ Fasten seat belts correctly.
- ▶ Always grip the steering wheel at the steering wheel rim. Place your hands in the 3 o'clock and 9 o'clock positions to minimise the risk of injury to hands or arms when the airbag deploys.
- ▶ Adjust the seat and steering wheel so the driver can reach over the steering wheel diagonally. Select the settings so that, when reaching over, the shoulders stay in contact with the backrest and the upper body stays as far away from the steering wheel as possible.
- ▶ Make sure that the front passenger is sitting correctly, i.e. with their feet and legs in the footwell, not resting on the dashboard.
- ▶ Make sure that vehicle occupants keep their head away from the side airbag.
- ▶ Do not place any other persons, pets or objects between the airbags and occupants.
- ▶ Keep the dashboard and windscreen area on the passenger's side clear, for example do not attach adhesive foil or covers and do not fit brackets for navigation devices or mobile phones, for example.
- ▶ Do not glue the airbag covers and do not cover or modify them in any way.
- ▶ Do not use the front airbag cover on the passenger's side as a tray.
- ▶ Keep stowage compartments in the area of the airbags closed, for example the glove compartment or the centre armrest.
- ▶ Do not install seat covers, cushions or other objects on the front seats if they are not specifically designed for use on seats with integral airbag variants.
- ▶ Do not hang items of clothing, for example coats or jackets, over the backrests.
- ▶ Do not modify individual components or wiring. This also applies to the covers of the steering wheel, the dashboard and seats.
- ▶ Do not dismantle the airbag system.

Even if all this information is observed, injuries resulting from contact with the airbag cannot be entirely ruled out in every situation.

The noise caused by the deployment of an airbag may lead to temporary hearing loss in vehicle occupants sensitive to noise.

Operational readiness of the airbag system

Safety information

WARNING

Individual components of the airbag system may be hot after airbag deployment. There is a danger of injury. Do not touch individual components.

WARNING

Work carried out incorrectly can cause the airbag system to fail, malfunction or deploy accidentally. If there is a malfunction, the airbag system might not deploy as intended in an accident, even if the impact is of the appropriate severity. There is a danger of injury or danger to life. Have the airbag system tested, repaired or removed and disposed of by an authorised Service Partner or another qualified Service Partner or a specialist workshop.

Display in the instrument cluster



When drive-ready state is switched on, the warning light in the instrument cluster illuminates briefly to indicate that the entire airbag system and the seat belt tensioners are operational.

Malfunction



- ▶ The warning light does not illuminate after drive-ready state is switched on.
- ▶ The warning light is permanently illuminated.

The airbag system or belt tensioners may be not functional. Have the vehicle checked immediately by an authorised Service Partner or

another qualified Service Partner or a specialist workshop.

Adjusting the front seat position

To maintain the accuracy of the seat position, calibrate the electric front seats as soon as a corresponding message is displayed on the control display.

For further information:

Seats, see page 106.

Deactivating the front passenger airbag

Principle

When using a rearward-facing child restraint system on the front passenger seat, the front passenger airbag can be deactivated via iDrive.

General

The availability of the function depends on the vehicle equipment and country.

The front passenger airbag can be deactivated and reactivated via iDrive on the control display. An indicator light shows the operating status.

Operating requirements

- ▶ Drive-ready state is switched off.
- ▶ Standby state is switched on.
- ▶ The vehicle key is in the vehicle.

Deactivating the front passenger airbag

1.  Apps menu
2. "Vehicle"
3. "Passenger airbag"

- "PASSENGER AIR BAG OFF"
5. Check the operation of the front passenger airbag using the indicator light and confirm.

The front passenger airbag is deactivated. The driver airbag remains active.

If a rearward-facing child restraint system is removed from the front passenger seat, reactivate the front passenger airbag so that it can deploy as intended in the event of an accident.

Activating the front passenger airbag

1.  Apps menu
2. "Vehicle"
3. "Passenger airbag"
4. "PASSENGER AIR BAG ON"
5. Check the operation of the front passenger airbag using the indicator light and confirm.

The front passenger airbag is reactivated and deploys in appropriate situations.

Front passenger airbag indicator light

The indicator light for the front passenger airbag in the headliner shows the operating status of the front passenger airbag.

After switching on standby state, the light illuminates briefly and then shows whether the airbag is activated or deactivated.

Display	Function
	When the front passenger airbag is activated, the indicator light illuminates for approx. 1 minute and then goes out.
	When the front passenger airbag is deactivated, the indicator light remains illuminated.



When the front passenger airbag is activated, the indicator light illuminates for approx. 1 minute and then goes out.



When the front passenger airbag is deactivated, the indicator light remains illuminated.

Check the status of the indicator light before and also while driving when the front passenger seat is occupied.

Active pedestrian protection

Principle

The active pedestrian protection raises the bonnet if the front of the vehicle collides with a pedestrian.

General

When triggered, the pedestrian protection creates deformation space underneath the bonnet in readiness for the subsequent head impact. Sensors behind the bumper are used for detection.

The system's gas pressure springs are only approved for a certain period of time. Check the gas pressure springs during maintenance and replace them as necessary.

Safety information

WARNING

The system may trigger inadvertently if contact is made with individual components of the hinges and bonnet locks. There is a danger of injury or material damage. Do not touch individual components of the hinges and bonnet locks.

WARNING

Modifications to the pedestrian protection can lead to a failure, a malfunction or accidental triggering of the pedestrian protection system. There is a danger of injury or danger to life. Do not modify the pedestrian protection, its individual components or its wiring. Do not dismantle the system.

**WARNING**

Work carried out incorrectly can lead to a failure, malfunction or accidental triggering of the system. If there is a malfunction, the system might not trigger as intended in an accident, even if the impact is of the appropriate severity. There is a danger of injury or danger to life. Have the system tested, repaired or removed and disposed of by an authorised Service Partner or another qualified Service Partner or a specialist workshop.

**WARNING**

If the system has been triggered or is damaged, its functionality will be restricted or it may no longer work at all. There is a danger of injury or danger to life.

If the system has been triggered or is damaged, have it checked and replaced at an authorised Service Partner or another qualified Service Partner or a specialist workshop.

**NOTICE**

Opening the bonnet when the pedestrian protection has triggered may damage the bonnet or the pedestrian protection. There is a risk of material damage. Do not open the bonnet after the Check Control message is displayed. Have it checked by an authorised Service Partner or another qualified Service Partner or a specialist workshop.

System limits

The active pedestrian protection is only triggered at speeds between approximately 30 km/h, 18 mph and 55 km/h, 34 mph.

For safety reasons, the system may also trigger in rare instances where impact with a pedestrian cannot be excluded beyond all doubt, for example in the following situations:

- ▷ Collision with objects such as a skip or a boundary post.
- ▷ Collision with animals.
- ▷ Stone impact.
- ▷ Driving into a snow drift.

Malfunction



A Check Control message is shown. The system has been triggered or is faulty.

Immediately drive at moderate speed to an authorised Service Partner or another qualified Service Partner or a specialist workshop to have the system checked and repaired.

Collision warning systems

General

Depending on the equipment, the vehicle has different systems that can help prevent an imminent collision.

- ▷ Front collision warning with brake intervention, see page [190](#)
- ▷ Exit warning, see page [199](#).
- ▷ Lane Departure Warning, see page [200](#).
- ▷ Lane Change Warning, see page [204](#).
- ▷ Side collision warning, see page [207](#).
- ▷ Rear collision warning, see page [209](#).
- ▷ Road Priority Warning, see page [209](#).
- ▷ Wrong-way Warning, see page [212](#).
- ▷ Emergency Stop Assistant, see page [213](#).

Safety information

**WARNING**

The system does not relieve you of your personal responsibility to assess the traffic situation correctly. Due to system limits, it cannot respond independently and appropriately in

all traffic situations. There is a risk of accident. Adapt your driving style to the traffic conditions. Observe the traffic situation, be ready to take over steering and braking at any time, and actively intervene if the situation warrants it.

WARNING

Displays and warnings do not relieve you of your personal responsibility. System limits can mean that warnings or system responses are not issued or are issued too late, incorrectly or for no reason. There is a risk of accident. Adapt your driving style to the traffic conditions. Observe the traffic situation and intervene actively if the situation warrants it

Sensors

Depending on the equipment, the Intelligent Safety systems are controlled by the following sensors:

- ▶ Camera behind the windscreen.
- ▶ Front radar sensor.
- ▶ Side radar sensors, front.
- ▶ Side radar sensors, rear.

For further information:

Sensors in the vehicle, see page 42.

Turning on/turning off collision warning systems

Depending on the national-market version, some of the systems are automatically active after every driving off.

The following functions are adjustable.

1.  Apps menu
2. "Vehicle"
3. "Driving settings"
4. "Driver assistance"

5. "Safety and warnings"
6. Select the desired settings.

Resetting settings

The settings of the collision warning systems can be reset to the default settings for vehicle delivery.

1.  Apps menu
2. "Vehicle"
3. "Driving settings"
4. "Driver assistance"
5. "Safety and warnings"
6. "Reset to recommended settings"

System limits

Safety information

WARNING

Due to system limitations, the system may not respond at all, or may respond too late, incorrectly or for no reason. There is a risk of accident or material damage. Observe the information on the system limits and intervene actively if necessary.

Detection capability

The detection capability of the system is limited.

The system only takes into account objects within the detection range of the installed sensors and that are detected by the system.

Depending on the equipment, the area is monitored by cameras or radar sensors.

For this reason, the system may fail to respond or only respond after a delay.

System limits of the sensors

For further information:

Sensors in the vehicle, see page 42.



Front collision warning with brake intervention

Principle

The front collision warning can help prevent accidents. If an accident cannot be avoided, the system may help reduce the severity of the accident.

The system can issue a warning of a possible risk of collision and may activate the brakes independently.

General

Depending on the equipment version, the front collision warning system includes the following functions:

- ▷ Warning function in rear collision situations, see page 193.
- ▷ Warning function for oncoming traffic, see page 194.
- ▷ Warning function for turning with oncoming traffic, see page 194.
- ▷ Warning function for pedestrians, see page 195.
- ▷ Warning function at road junctions, see page 197.
- ▷ Evasion Assistant, see page 198.

Safety information

WARNING

The system does not relieve you of your personal responsibility to assess the traffic situation correctly. Due to system limits, it cannot respond independently and appropriately in all traffic situations. There is a risk of accident. Adapt your driving style to the traffic conditions. Observe the traffic situation, be ready to take over steering and braking at any time, and actively intervene if the situation warrants it.

WARNING

Displays and warnings do not relieve you of your personal responsibility. System limits can mean that warnings or system responses are not issued or are issued too late, incorrectly or for no reason. There is a risk of accident. Adapt your driving style to the traffic conditions. Observe the traffic situation and intervene actively if the situation warrants it

WARNING

Individual functions may malfunction when tow-starting or towing away with activated front collision warning or Cruise Control switched on. There is a risk of accident. Turn off the front collision warning and Cruise Control before tow-starting or towing away.

Sensors

Depending on the equipment, the system is controlled by the following sensors:

- ▷ Camera behind the windscreen.
- ▷ Front radar sensor.
- ▷ Side radar sensors, front.

For further information:

Sensors in the vehicle, see page 42.

Speed range

The system issues a warning of a possible risk of collision at speeds above approx. 5 km/h/3 mph.

The system is temporarily disabled at speeds over approx. 250 km/h, 155 mph.

Some functions are deactivated earlier.

As soon as the speed drops below these values again, the system is activated.

Turning the front collision warning on/off

Switching on the system automatically

Depending on the national-market version, the system is automatically active after every driving off.

Switching the system on manually

The system is activated when the warning time is set.

For further information:

Setting the warning time, see page 191.

Switching the system off manually

Depending on the national-market version, the setting can only be made at a vehicle standstill or in the very low speed range.

If necessary, the switch-off must be confirmed successively on the control display.

1.  Apps menu
2. "Vehicle"
3. "Driving settings"
4. "Driver assistance"
5. "Safety and warnings"
6. "Front collision warning"
7. "Off"

Setting the warning time







1.  Apps menu
2. "Vehicle"
3. "Driving settings"
4. "Driver assistance"
5. "Safety and warnings"
6. "Front collision warning"
7. Select the desired setting.

The higher the sensitivity of the warning time settings the more warnings are displayed. The system may therefore also issue more early or unfounded warnings and reactions.

The system checks for visual impairments. Depending on equipment, the Driver Attention Camera in the instrument cluster monitors the driver's gaze behaviour. Visibility conditions and field of vision also affect the timing of the warnings.

Display in the instrument cluster

The following indicator lights and warning lights are shown in the instrument cluster and, depending on the equipment, in the Head-up display:

Icon	Meaning
	Depending on equipment and national-market version: Functional limitation detected, for example, due to system limits of the cameras or system failure. It is possible to continue driving. Where applicable, observe the information from Check Control messages. System limits of the cameras, see page 42.
	Depending on equipment and national-market version: The system is switched off.
	Risk of collision with a person, e.g., pedestrian.
	Risk of collision, for example, with an oncoming or a vehicle driving in front.
	Risk of collision, e.g. with a crossing vehicle from the right.
	Risk of collision, e.g. with a crossing vehicle from the left.
	General risk of collision.



The display of the respective indicator light and warning light may vary because the system may detect multiple objects.

Warning function

The front collision warning warns on different warning levels, depending on the respective hazardous situation.

In the event of an advance warning, a warning light illuminates red. In the event of an acute warning, a warning light flashes red and an acoustic warning signal sounds.

In the event of a system warning, the driver must intervene immediately and in accordance with the situation.

- ▷ A red warning light is illuminated:
A hazardous situation has been detected. Increased awareness is required.
- ▷ A red warning light flashes:
There is a risk of collision. Intervene yourself immediately.
- ▷ A warning signal sounds:
There is a risk of collision. Intervene yourself immediately.
- ▷ Automatic brake intervention:
Depending on the equipment and situation in case of an imminent danger of collision, the system can also intervene with an automatic brake intervention and automatically decelerate the vehicle, if necessary, to a complete standstill.

When the brake pedal is pressed quickly and hard, the maximum brake force of the vehicle is used.

Automatic brake intervention

In case of a risk of collision, the system can assist with an automatic brake intervention, if necessary.

At low speeds, the vehicle can be braked to a standstill.

In the event of automatic brake intervention, Dynamic Stability Control may be activated automatically.

A brake intervention can be cancelled by sufficiently stepping on the accelerator pedal, releasing the brake pedal or with an active steering wheel movement.

Depending on the equipment and situation, the brake intervention can occur at speeds of up to approx. 250 km/h/155 mph.

At speeds above approx. 210 km/h/130 mph, only a brief brake intervention will occur.

System limits

Safety information

WARNING

Due to system limitations, the system may not respond at all, or may respond too late, incorrectly or for no reason. There is a risk of accident or material damage. Observe the information on the system limits and intervene actively if necessary.

Detection capability

The detection capability of the system is limited.

The system only takes into account objects within the detection range of the installed sensors and that are detected by the system.

Depending on the equipment, the area is monitored by cameras or radar sensors.

For this reason, the system may fail to respond or only respond after a delay.

System limits of the sensors

For further information:

Sensors in the vehicle, see page [42](#).

Functional limitations

The system may have restricted functionality in situations such as the following:

- ▶ In tight bends.
- ▶ With restriction of the driving stability control systems.
- ▶ Up to 10 seconds after switching on drive-ready state using the Start/Stop button.

Warning function in rear collision situations

Principle

The warning function in rear collision situations warns of a possible risk of collision and may brake independently.

If an accident cannot be avoided, the system helps to reduce the collision speed.

General

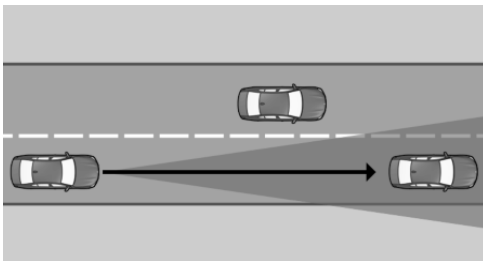

Sensors detect the traffic situation in their detection range.

The system issues a warning of a possible risk of collision with vehicles at speeds above approx. 5 km/h/3 mph. The timing of these warnings may vary depending on the current driving situation.

The driver's own driving behaviour is taken into account in the responses of the system. If an active driving style is detected, warnings and brake interventions are output less frequently.

Safety information

Follow the Safety Information in Chapter "Front collision warning".

Display in the instrument cluster

If there is a risk of collision with a detected vehicle, a warning light is displayed.

Icon	Meaning
	Collision Warning with a detected vehicle.
	General risk of collision.



Collision Warning with a detected vehicle.



General risk of collision.

Warning function

The warning prompts the driver to intervene personally.

For further information:

Front collision warning, see page 190.

System limits

General

Follow the limits of the system in the chapter "Front collision warning".

Detection range

The following situations may not be detected, or only detected with a delay, for instance:

- ▶ Slow driving vehicle in front being approached at high speed.
- ▶ Vehicles suddenly cutting in or decelerating heavily.
- ▶ Vehicles with unusual rear design.



Warning function for oncoming traffic

Principle

The Warning function for oncoming traffic can issue a warning of a possible risk of collision with oncoming vehicles and apply the brakes independently, if needed.

If an accident cannot be avoided, the system helps to reduce the collision speed.

General

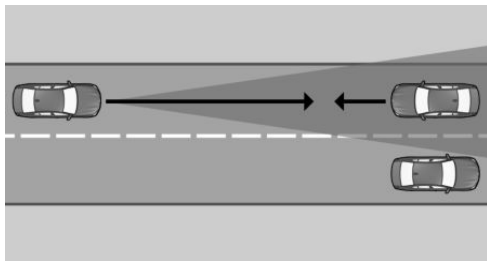

Sensors detect the traffic situation in their detection range.

The system issues a warning of a possible risk of collision with vehicles at speeds above approx. 5 km/h/3 mph. The timing of these warnings may vary depending on the current driving situation.

Safety information

Follow the Safety Information in Chapter "Front collision warning".

Display in the instrument cluster

If there is a risk of collision with a detected vehicle, a warning light is displayed.

Icon	Meaning
	Oncoming traffic warning when a vehicle is detected.
	General risk of collision.



Oncoming traffic warning when a vehicle is detected.



General risk of collision.

Warning function

The warning prompts the driver to intervene personally.

In case of a risk of collision, a brake intervention is triggered.

For further information:

Front collision warning, see page 190.

System limits

General

Follow the limits of the system in the chapter "Front collision warning".

Detection range

For example the following might not be detected:

- ▷ Oncoming vehicles at a very high speed.
- ▷ Vehicles with an unusual front view.

Warning function for turning with oncoming traffic

Principle

There is a risk of an accident with oncoming vehicles when turning across the oncoming lane. The system can issue a warning of a possible risk of collision and may activate the brakes independently.

If an accident cannot be avoided, the system helps to reduce the collision speed.

General

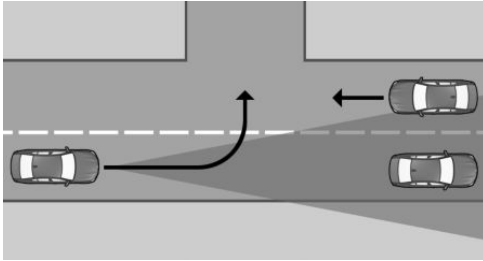

Sensors detect the traffic situation in their detection range.

The system issues a warning of a possible risk of collision with oncoming vehicles at speeds from approx. 5 km/h/3 mph. The timing of these warnings may vary depending on the current driving situation.

Safety information

Follow the Safety Information in Chapter "Front collision warning".

Display in the instrument cluster

If there is a risk of collision with a detected vehicle, a warning light is displayed.

Icon	Meaning
	Oncoming traffic warning when a vehicle is detected.
	General risk of collision.

Warning function

The warning prompts the driver to intervene personally.

For further information:

Front collision warning, see page [190](#).

System limits

General

Follow the limits of the system in the chapter "Front collision warning".

Detection range

For example the following might not be detected:

- ▷ Oncoming vehicles at a very high speed.
- ▷ Vehicles that are hidden by other vehicles.
- ▷ Vehicles with an unusual front view.

Upper speed limit

The system is active when the own speed is below approx. 25 km/h/15 mph.

Warning function for pedestrians

Principle

The warning function for pedestrians warns of the risk of collision with pedestrians and cyclists at speeds that are common in towns and cities. The system may brake automatically if necessary.

If an accident cannot be avoided, the system helps to reduce the collision speed.

General

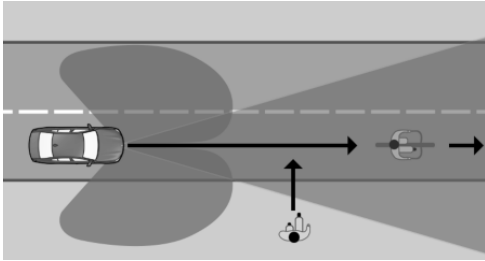

Sensors detect the traffic situation in their detection range on a straight line.

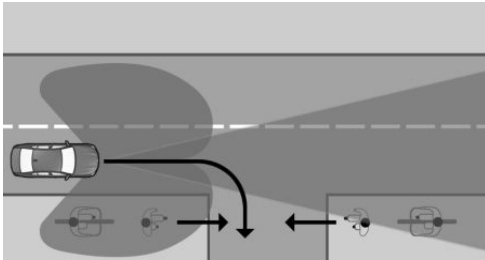

Sensors detect the traffic situation in their detection range when turning off.

At vehicle speeds greater than approx. 5 km/h, approx. 3 mph, this system warns of a possible risk of collision with pedestrians or cyclists.

Safety information

Follow the Safety Information in Chapter "Front collision warning".

Display in the instrument cluster

A warning light is displayed if there is a risk of collision with a detected pedestrian or cyclist.

Icon	Meaning
	Risk of collision with a person, e.g., pedestrian.
	General risk of collision.

Warning function

The warning prompts the driver to intervene personally.

For further information:

Front collision warning, see page 190.

System limits

General

Follow the limits of the system in the chapter "Front collision warning".

Detection range

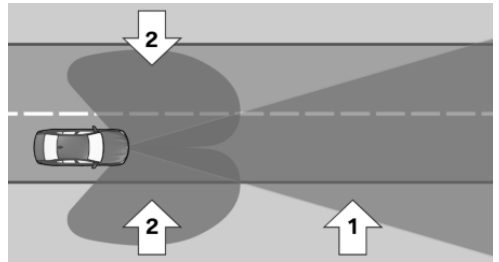

The detection range consists of the following parts:

- ▶ Area in front of the vehicle, arrow 1.
- ▶ With side radar sensors in front: side areas, arrows 2.

For example the following might not be detected:

- ▶ Partially covered pedestrians or bikes.
- ▶ Pedestrians that are not detected as such because of their contour or posture.
- ▶ Pedestrians with insufficient height.

Upper speed limit

Depending on vehicle equipment, the system responds to pedestrians and cyclists when the vehicle speed is less than approx. 80 km/h, approx. 50 mph.

Warning function at road junctions

Principle

The warning function at road junctions can warn of a possible risk of collision with crossing traffic at intersections and junctions at speeds that are common in towns and cities. The system may brake automatically if necessary.

If an accident cannot be avoided, the system helps to reduce the collision speed.

General

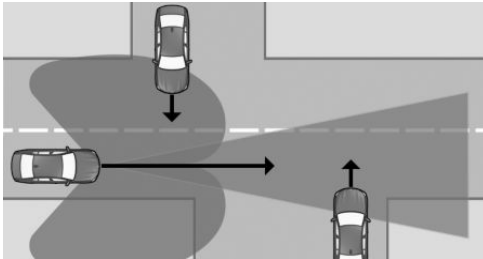

Sensors detect the traffic situation in their detection range.

Vehicles that cross the vehicle's direction of travel can be detected by the system as soon as these vehicles enter the detection range of the sensors.

A warning is given at road junctions and cross-roads if there is a risk of collision with crossing traffic.

The system issues a warning of a possible risk of collision with vehicles at speeds above approx. 5 km/h/3 mph.



The timing of these warnings may vary depending on the current driving situation.

Safety information

Follow the Safety Information in Chapter "Front collision warning".

Display in the instrument cluster

If there is a risk of collision with a detected vehicle, a warning light is displayed.

Icon	Meaning
	Risk of collision with crossing vehicle from right.
	Risk of collision with crossing vehicle from left.
	General risk of collision.

Warning function

The warning prompts the driver to intervene personally.

For further information:

Front collision warning, see page [190](#).

System limits

General

Follow the limits of the system in the chapter "Front collision warning".

Detection range

For example the following might not be detected:

- ▶ Crossing vehicles concealed by buildings, for example.
- ▶ Vehicles with an unusual side appearance.
- ▶ Vehicles in highly dynamic driving situations.

Upper speed limit

The system responds to crossing vehicles when your own speed is below approx. 80 km/h, approx. 50 mph.



Evasion Assistant

Principle

The Evasion Assistant can support the driver in making evasive manoeuvres in certain situations, for example, when obstacles or persons suddenly appear.

General

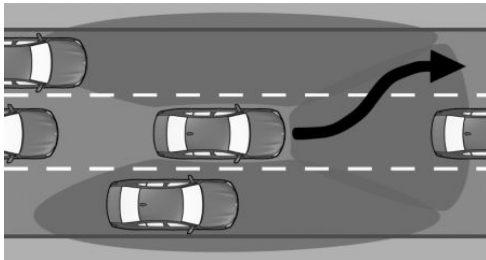

The system issues warnings and intervenes to provide support if there is a possibility to take an avoidance manoeuvre to the side.

Sensors monitor and detect the clearance in front of the vehicle. Depending on the equipment, the areas next to the vehicle are also monitored.

The system uses a detected free space for avoidance by safely supporting the avoidance manoeuvre carried out by the driver with automatic steering movements.

Safety information

Follow the Safety Information in Chapter "Front collision warning".

Operating requirements

- ▶ Front collision warning is active.
- ▶ Sensors detect adequate space around the vehicle.

Display in the instrument cluster

A warning light is displayed if there is a risk of collision with a detected vehicle or person, e.g., pedestrian.

Icon Meaning



Warning when a vehicle is detected.



Risk of collision with a pedestrian.



Risk of collision with an unknown obstacle.

Warning function with evasion support

If the vehicle approaches another object at a high differential speed, a warning is displayed if there is an immediate risk of collision.

Intervene in case of a warning.

The system provides support for the driver's avoidance manoeuvres if there is a risk of collision.

A message in the instrument cluster and, depending on the equipment, in the Head-up display signals the evasion support.

System limits

General

Follow the limits of the system in the chapter "Front collision warning".

Detection range

For example the following might not be detected:

- ▶ Slow driving vehicle in front being approached at high speed.
- ▶ Vehicles suddenly cutting in or decelerating heavily.

- ▷ Vehicles with unusual rear design.
- ▷ Two-wheeled vehicles ahead.
- ▷ Partially covered pedestrians or bikes.
- ▷ Pedestrians that are not detected as such because of their contour or posture.
- ▷ Pedestrians with insufficient height.

Exit warning

Principle

The exit warning helps to avoid accidents.

The system can warn the passengers when they are opening the doors and a risk of collision with approaching objects is detected.

General

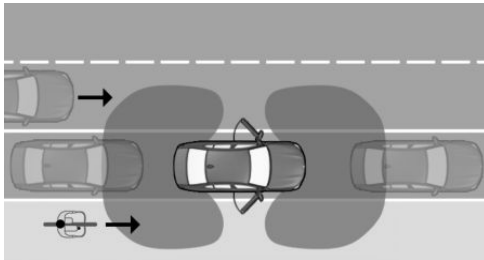

Two radar sensors in the rear bumper monitor the area behind the vehicle.

Depending on the equipment, the area in front of the vehicle is also monitored. For this purpose, two further radar sensors are located in the front bumper.

The system monitors the area around the vehicle for a limited time after getting in or after parking.

A possible risk of collision is indicated by various warning functions.

Safety information

Follow the safety information in the Chapter "Collision warning systems".

Sensors

The system is controlled using the following sensors:

- ▷ Side radar sensors, rear.
- ▷ Depending on the equipment: side radar sensors, front.

Turning the exit warning on/off

Switching on the system automatically

The exit warning activates automatically after departure if the function was turned on at the end of the last journey.

Switching the system off manually

1.  Apps menu
2. "Vehicle"
3. "Driving settings"
4. "Driver assistance"
5. "Safety and warnings"
6. "Exit warning"
7. "Off"

Adjusting the exit warning

1.  Apps menu
2. "Vehicle"
3. "Driving settings"
4. "Driver assistance"
5. "Safety and warnings"
6. "Exit warning"
7. Select the desired setting.

Switching the warning signal on/off

1.  Apps menu
2. "Vehicle"
3. "Driving settings"
4. "Driver assistance"
5. "Safety and warnings"

6. "Exit warning"
7. "Warning tone"

Displays

Warning light in the exterior mirror



The warning light in the exterior mirror warns of a possible collision with a detected vehicle.

Ambient lighting

Depending on the equipment, warnings are also indicated by the ambient lighting in the interior.

Warning function

Advance warning

In the event of an advance warning, the warning light in the exterior mirror is illuminated. Depending on the equipment, the ambient lighting also flashes.

An object was detected in the opening range. Increased awareness is required.

Acute warning

In the event of an acute warning, the warning light in the exterior mirror flashes and, depending on the equipment, the ambient lighting also flashes. An acoustic signal also sounds.

There is a risk of collision when opening the doors.

System limits

General

Follow the limits of the system in the chapter "Collision warning systems".

Detection range

For example the following might not be detected:

- ▷ Fully or partially hidden objects.
- ▷ Stationary or very slow objects.
- ▷ Pedestrians.

Functional limitations

The system may have restricted functionality in situations such as the following:

- ▷ The speed of an approaching vehicle is too fast or too slow.
- ▷ In curves.
- ▷ In case of fully or partially hidden objects.

Lane Departure Warning with active return

Principle

The Lane Departure Warning issues a warning if the vehicle leaves the road or its driving lane.

An automatic steering intervention may help in keeping the vehicle in its lane.

General

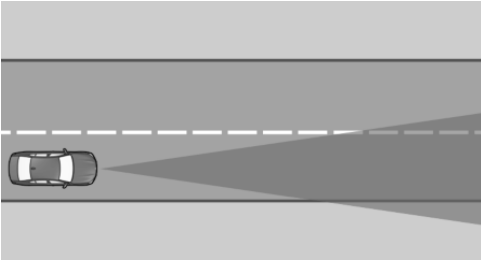

Sensors detect the traffic situation in their detection range.

The system issues a warning starting at a minimum speed. The minimum speed is country-specific and displayed on the control display.

Warnings are displayed in the instrument cluster. In addition, the steering wheel is vibrating.

The system does not issue a warning if the driver indicates in the corresponding direction before leaving the driving lane.

Safety information

WARNING

The system does not relieve you of your personal responsibility to assess the layout of the road and the traffic situation. There is a risk of accident. Adapt your driving style to the traffic conditions. Observe the traffic situation and intervene actively if the situation warrants it. In the event of a warning, do not move the steering wheel unnecessarily abruptly.

WARNING

Displays and warnings do not relieve you of your personal responsibility. System limits can mean that warnings or system responses are not issued or are issued too late, incorrectly or for no reason. There is a risk of accident. Adapt your driving style to the traffic

conditions. Observe the traffic situation and intervene actively if the situation warrants it

Operating requirements

The lane marking must be detected by the camera in order for the Lane Departure Warning to be active.

The areas of the sensors must be clean and clear.

Sensors

Depending on the equipment, the system is controlled by the following sensors:

- ▶ Camera behind the windscreen.
- ▶ Front radar sensor.
- ▶ Side radar sensor, front.
- ▶ Side radar sensor, rear.

Turning the Lane Departure Warning on/off

Switching on the system automatically

Depending on the national-market version, the system is automatically active after every driving off.

Switching the system on manually

The system is activated when the warning time is set.

For further information:

Setting the warning time, see page [202](#).

Switching the system off manually

Depending on the equipment and national-market version, the switch-off must be confirmed successively on the control display.

1.  Apps menu
2. "Vehicle"
3. "Driving settings"
4. "Driver assistance"



5. "Safety and warnings"
6. "Lane departure warning"
7. "Off"

Setting the Lane Departure Warning

Setting the warning time

1. Apps menu
2. "Vehicle"
3. "Driving settings"
4. "Driver assistance"
5. "Safety and warnings"
6. "Lane departure warning"
7. Select the desired setting.

- ▷ "Expanded"

If the system detects that the vehicle is about to leave the lane or cross a lane marking, a warning is issued. The system performs a steering intervention.

- ▷ "In dangerous situations"

If the lane marking is interrupted: if driving over the lane is detected as unintentional or the sensors detect an oncoming vehicle, a warning is issued and steering intervention is carried out.

If the lane markings are solid, depending on the national-market version: if the system detects that the vehicle is unintentionally leaving the lane or crossing a lane marking, a warning is issued and a steering intervention is performed.

Adjusting the strength of the steering wheel vibration

1. Apps menu
2. "Vehicle"
3. "Driving settings"
4. "Driver assistance"
5. "Feedback via steering wheel"

6. "Vibration intensity"
7. Select the desired setting.

The setting is applied to all collision warning systems.

Depending on the national-market version: switch steering intervention on/off

1. Apps menu
2. "Vehicle"
3. "Driving settings"
4. "Driver assistance"
5. "Safety and warnings"
6. "Lane departure warning"
7. "Steering intervention"

Depending on the national-market version, steering intervention is automatically active whenever you drive off.

Display in the instrument cluster

Depending on the equipment and national-market version, different system statuses are displayed in the instrument cluster.

Icon	Meaning
	The indicator light flashes green: the system actively issues a warning. If necessary, the system performs a steering intervention.
	The warning light is illuminated yellow: functional limitation detected, for example, due to low sun or system failure. It is possible to continue driving. Where applicable, observe the information from Check Control messages.
	The warning light flashes yellow: a warning is issued actively. The system does not carry out any steering interventions.



The indicator light flashes green: the system actively issues a warning. If necessary, the system performs a steering intervention.



The warning light is illuminated yellow: functional limitation detected, for example, due to low sun or system failure. It is possible to continue driving. Where applicable, observe the information from Check Control messages.



The warning light flashes yellow: a warning is issued actively. The system does not carry out any steering interventions.

Icon	Meaning
	The warning light is illuminated grey: the system is switched off or automatically deactivated, for example, because DSC OFF is activated.
Or	
	
	The warning light flashes grey: a warning is issued actively. The system does not carry out any steering interventions.



Depending on vehicle equipment and national-market version, the information from the system in Assisted View is displayed on the instrument cluster.

For further information:

Assisted View, see page 165.

Warning function

When leaving the driving lane

If the vehicle leaves the driving lane and a lane boundary is detected, the steering wheel vibrates depending on the steering wheel vibration setting.

 In addition, the indicator light flashes green.

If the turn indicator is switched on in the corresponding direction before changing lanes, no warning is issued.

Steering intervention

Depending on the national-market version and equipment: if a lane boundary is crossed in the speed range up to 210 km/h, approx. 130 mph, the system may respond with an active steering intervention in addition to the steering wheel vibration. The system is helping the driver keep the vehicle in the driving lane. Steering intervention can be felt at the steering

wheel, and can be overridden manually at any time.

 When steering intervention is active, the indicator light flashes green.

For example, steering intervention is suppressed in the following situations:

- ▶ If the vehicle is accelerating rapidly or braking heavily.
- ▶ On indicating.
- ▶ If the hazard warning lights are switched on.
- ▶ In driving situations with high driving dynamics.
- ▶ When Dynamic Stability Control is regulating the driving stability.
- ▶ While Dynamic Stability Control is restricted.
- ▶ Directly after a steering intervention by the vehicle systems.

Warning signal

Depending on the national-market version: in the event of multiple active steering interventions by the system within 3 minutes without the driver's intervention at the steering wheel during the steering intervention itself, an acoustic warning will sound. A short warning signal will sound at the second steering intervention. A longer warning signal sounds from the third steering intervention onwards.

A Check Control message is also displayed.

The warning signal and Check Control message advise to pay closer attention to the lane.

The extended warning tone is disrupted in the event of manual steering wheel movements.

In trailer operation

If the trailer socket is occupied or the trailer operation is activated, for example during operation with a trailer, no steering intervention takes place.

When a rear carrier is used on the trailer tow hitch, this limitation does not apply when the trailer mode is activated accordingly on the control display.

For further information:

Driving with a trailer or rear carrier, see page 333.

Cancellation of the warning

For example, the warning or an active steering intervention is cancelled in the following situations:

- ▷ Automatically after a few seconds.
- ▷ On returning to the correct lane.
- ▷ If the vehicle is accelerating rapidly or braking heavily.
- ▷ If the hazard warning lights are switched on.
- ▷ On indicating.
- ▷ When Dynamic Stability Control is regulating the driving stability.
- ▷ Directly after a steering intervention by the vehicle systems.
- ▷ With manual steering intervention.
- ▷ Possibly when another driver assistance system is activated.
- ▷ No lane boundary detected.
- ▷ When the system limits are reached.

System limits

General

Follow the limits of the system in the chapter "Collision warning systems".

Functional limitations

The system may have restricted functionality in situations such as the following:

- ▷ When there are missing, worn, poorly visible, merging/separating or ambiguous lane

boundaries, for example, in areas where there are roadworks.

- ▷ With lane boundaries that are covered in snow, ice, dirt or water.
- ▷ In tight corners or on narrow roads.
- ▷ With lane boundaries that are not white.
- ▷ With lane boundaries that are covered by objects.
- ▷ If the vehicle is too close to the vehicle ahead.
- ▷ Up to 10 seconds after switching on drive-ready state using the Start/Stop button.

A Check Control message may be displayed if functionality is restricted. Depending on the national-market version, a yellow warning light is also illuminated.

Lane Change Warning with active return

Principle

Lane Change Warning detects vehicles in the blind spot, or if vehicles are approaching from behind in the adjacent lane.

The warning light in the exterior mirror warns in different stages.

An automatic steering intervention may help in keeping the vehicle in its lane.

General

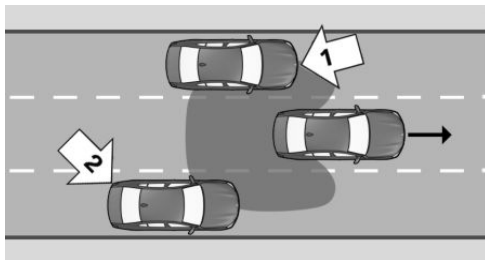

The system is operational after a minimum speed has been reached and uses radar sen-

sors to monitor the area behind and adjacent to the vehicle.

The minimum speed is country-specific and displayed in the Lane Change Warning menu.

The system indicates when vehicles are in the blind spot, arrow 1, or are approaching from the rear in an adjacent lane, arrow 2. The warning light in the exterior mirror is illuminated at a dimmed level.

In the previously named situations, the system will warn prior to a lane change. The warning light in the exterior mirror flashes and the steering wheel vibrates.

When turning at a speed of up to approx. 20 km/h, approx. 12 mph, the steering wheel will not vibrate.

Safety information

Follow the safety information in the Chapter "Collision warning systems".

Sensors

The system is controlled using the following sensors:

- ▶ Camera behind the windscreen.
- ▶ Side radar sensors, rear.
- ▶ Depending on the equipment: side radar sensors, front.

Operating requirements

The areas of the sensors must be clean and clear.

Turning the Lane Change Warning on/off

1.  Apps menu
2. "Vehicle"
3. "Driving settings"
4. "Driver assistance"
5. "Safety and warnings"

6. "Lane change warning"
7. Select the desired setting.

Depending on the equipment and national-market version, the system is automatically active after every driving off.

Adjusting the Lane Change Warning

Setting the warning time

1.  Apps menu
2. "Vehicle"
3. "Driving settings"
4. "Driver assistance"
5. "Safety and warnings"
6. "Lane change warning"
7. Select the desired setting.

Adjusting the strength of the steering wheel vibration

1.  Apps menu
2. "Vehicle"
3. "Driving settings"
4. "Driver assistance"
5. "Feedback via steering wheel"
6. "Vibration intensity"
7. Select the desired setting.

The setting is applied to all collision warning systems.

Depending on the national-market version: switch steering intervention on/off

1.  Apps menu
2. "Vehicle"
3. "Driving settings"
4. "Driver assistance"
5. "Safety and warnings"
6. "Lane change warning"
7. "Steering intervention"

Warning function

Warning light in the exterior mirror



The warning light in the exterior mirror warns of a possible collision with a detected vehicle.

Advance warning

The dimmed warning light in the exterior mirror indicates when vehicles are in the blind spot or are approaching from the rear.

Acute warning

In the event of an acute warning, the steering wheel vibrates briefly. The warning light in the exterior mirror flashes brightly.

An acute warning is issued if the following conditions are met:

- ▶ Another vehicle is located in the critical area.
- ▶ Your own vehicle is approaching the other lane.
- ▶ Depending on the system setting when the turn indicator is turned on.

The warning stops when the other vehicle has left the critical area.

Steering intervention

Depending on the national-market version: if there is no response to the steering wheel vibrations and a lane boundary is crossed at speeds of up to 210 km/h, approx. 130 mph, the system responds with an active steering intervention if necessary. The steering inter-

vention helps to return the vehicle to its driving lane. Steering intervention can be felt at the steering wheel, and can be overridden manually at any time.

The steering intervention is carried out from a minimum speed. The minimum speed is displayed on the control display.

In trailer operation

No steering intervention is performed when the trailer power socket is occupied or trailer operation is activated.

Depending on vehicle equipment and national-market version: system does not issue an advance warning. If there is a risk of collision, an acute warning will continue to be issued.

The warning function may be limited. Warnings may display late or not at all, e.g., if the speed of the approaching vehicle is much higher than the own speed. Increased false alarms may occur. A Check Control message is shown.

Brief flashing of the warning light

Brief flashing of the warning light in exterior mirror during vehicle unlocking serves as system self-test.

System limits

General

Follow the limits of the system in the chapter "Collision warning systems".

Upper speed limit

The system is temporarily disabled at speeds over approx. 250 km/h, 155 mph.

The system is activated again at speeds under approx. 250 km/h, approx. 155 mph.

Warning displays

Depending on the selected setting for warnings, for example the warning time, it is possible that more or fewer warnings will be

displayed. As a result, there may also be an increased number of premature warnings about critical situations.

Functional limitations

The system may have restricted functionality in situations such as the following:

- ▶ The speed of the approaching vehicle is much faster than your own speed.
- ▶ In tight corners or on narrow roads.
- ▶ The bumper is dirty, iced up or covered, for instance by stickers.

Depending on the national-market version, the steering intervention may be restricted, for example in the following situations:

- ▶ When there are missing, worn, poorly visible, merging/separating or ambiguous lane boundaries, for example, in areas where there are roadworks.
- ▶ With lane boundaries that are covered in snow, ice, dirt or water.
- ▶ With lane boundaries that are not white.
- ▶ With lane boundaries that are covered by objects.
- ▶ If the vehicle is too close to the vehicle ahead.
- ▶ If the camera is impaired.
- ▶ Up to 10 seconds after switching on drive-ready state using the Start/Stop button.

A Check Control message may be displayed if functionality is restricted. Depending on the national-market version, a yellow warning light is also illuminated.

Side collision warning

Principle

The side collision warning helps to avoid an imminent side collision.

General

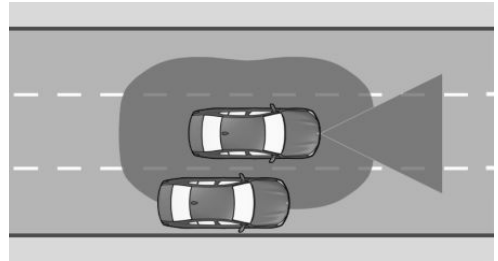

Radar sensors monitor the area adjacent to the vehicle from a minimum speed up to approximately 210 km/h, approx. 130 mph.

The minimum speed is country-specific and displayed on the control display.

If another vehicle is detected adjacent to the vehicle – and there is a risk of a side collision – the system helps the driver to avoid a collision. For this purpose, the system issues a warning with a flashing LED in the exterior mirror, a Check Control message and a vibrating steering wheel. An active steering intervention is performed by the system if necessary.

Safety information

Follow the safety information in the Chapter "Collision warning systems".

Operating requirements

The camera behind the windscreen detects the position of the lane boundaries.

The lane boundaries must be detected by the camera in order for the side collision warning with steering intervention to be active.

Sensors

The system is controlled using the following sensors:

- ▶ Camera behind the windscreen.
- ▶ Side radar sensors, front.
- ▶ Side radar sensors, rear.

Turning the side collision warning on/off

1.  Apps menu
2. "Vehicle"
3. "Driving settings"
4. "Driver assistance"
5. "Safety and warnings"
6. "Side collision warning"
7. Select the desired setting.

Adjusting the strength of the steering wheel vibration

1.  Apps menu
2. "Vehicle"
3. "Driving settings"
4. "Driver assistance"
5. "Feedback via steering wheel"
6. "Vibration intensity"
7. Select the desired setting.

The setting is applied to all collision warning systems.

Displays in the instrument cluster

Depending on vehicle equipment and national-market version, the information from the system in Assisted View is displayed on the instrument cluster.

For further information:

Assisted View, see page [165](#).

Warning function

Warning light in the exterior mirror



The warning light in the exterior mirror warns of a possible collision with a detected vehicle.

Acute warning

If there is a risk of collision, the warning light in the exterior mirror flashes and the steering wheel starts vibrating.

A Check Control message is displayed at the same time.

Steering intervention

Depending on the national-market version, an active steering intervention takes place if necessary to prevent a collision and keep the vehicle in its own lane. Steering intervention can be felt at the steering wheel, and can be overridden manually at any time.

System limits

General

Follow the limits of the system in the chapter "Collision warning systems".

Functional limitations

The system may have restricted functionality in situations such as the following:

- ▶ In tight corners or on narrow roads.
- ▶ When there are missing, worn, poorly visible, merging/separating or ambiguous lane

boundaries, for example, in areas where there are roadworks.

- ▷ With lane boundaries that are covered in snow, ice, dirt or water.
- ▷ With lane boundaries that are not white.
- ▷ With lane boundaries that are covered by objects.
- ▷ If the vehicle is too close to the vehicle ahead.
- ▷ Up to 10 seconds after switching on drive-ready state using the Start/Stop button.

A Check Control message may be displayed if functionality is restricted.

The system is inactive when the trailer socket is occupied or when the trailer operation is activated, for example, when operating with a trailer or rear bicycle carrier. A Check Control message is shown.

Rear collision warning

Principle

Depending on vehicle equipment and national-market version, the rear collision warning can respond to vehicles approaching from behind.

General

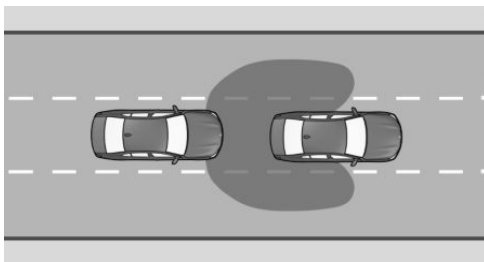

Radar sensors monitor the area behind the vehicle.

If a vehicle is approaching from behind at a relevant speed, the system can respond as follows:

- ▷ The hazard warning lights are switched on if appropriate.
- ▷ PreCrash functions are triggered if appropriate.

Safety information

Follow the safety information in the Chapter "Collision warning systems".

Sensors

The system is controlled via the radar sensors at the side in the rear.

Switching rear collision warning on/off

The system is automatically activated at the start of each journey.

The system is deactivated in the following situations:

- ▷ When reversing.
- ▷ If the trailer socket is occupied or trailer operation is activated, for example when operating with a trailer or rear bicycle carrier.

System limits

General

Follow the limits of the system in the chapter "Collision warning systems".

Functional limitations

The function may be restricted if the speed of the approaching vehicle is much higher or similar to the own speed.

Road Priority Warning

Principle

The Road Priority Warning provides support in situations where road signs or traffic lights indicate that the driver must give way.

General

The system uses a camera behind the windscreen to evaluate the road signs and traffic lights.

The navigation system forwards information regarding the road layout to the system.

A warning is given if a right-of-way is about to be violated in the following traffic situations, for example:

- ▷ At a road junction.
- ▷ At a T-junction.
- ▷ On an entry slip road slip road.
- ▷ At a roundabout.
- ▷ In the event of a red traffic light.

Starting from a variable minimum speed, the system issues warnings from and up to approximately 80 km/h, approx. 50 mph.

The following road signs are taken into account for the Road Priority Warning:

Signs	Meaning
	Give way signs: An advance warning is issued for these road signs.
	Stop signs. An advance warning and an acute warning are issued for these road signs.
	Red traffic lights result in output of an advance warning and an acute warning.



Give way signs:

An advance warning is issued for these road signs.



Stop signs.

An advance warning and an acute warning are issued for these road signs.



Red traffic lights result in output of an advance warning and an acute warning.

Safety information

Follow the safety information in the Chapter "Collision warning systems".

Operating requirements

The road priority situation must be unambiguously directed by road signs or light signal systems.

Sensors

The system is controlled by the camera behind the windscreen.

Turning the Road Priority Warning on/off

1.  Apps menu
2. "Vehicle"
3. "Driving settings"
4. "Driver assistance"
5. "Safety and warnings"
6. "Road Priority Warning"
7. Select the desired setting.

Setting the warning time

1.  Apps menu
2. "Vehicle"
3. "Driving settings"
4. "Driver assistance"
5. "Safety and warnings"
6. "Road Priority Warning"
7. Select the desired setting.

The selected setting is saved and adopted for the next journey.

Warning function

General



The system warns in two stages:

- ▷ Advance warning; visually by means of an icon in the instrument cluster.
- ▷ Acute warning; visually by means of an icon in the instrument cluster and with an additional acoustic signal.

The timing of the warnings may vary depending on the current driving situation and the set warning time.

Advance warning



If there is a risk that road priority is about to be ignored, one of the following icons appears in the instrument cluster:

Icon	Meaning
	Give way.
	Stop.
	Red traffic light.

When an advance warning is issued, intervene as appropriate for the situation; for example, by braking.

Acute warning

If there is an imminent risk that right-of-way is about to be ignored, an acoustic signal sounds and one of the following icons appears in the instrument cluster:

Icon	Meaning
	Stop.
	Red traffic light.

When an acute warning is issued, immediately intervene as appropriate for the situation; for example, by braking.

Display in the Head-up display

Depending on the equipment, the warning is displayed in the Head-up display at the same time as in the instrument cluster.

System limits

General

Follow the limits of the system in the chapter "Collision warning systems".

No Warning

The system provides no warning in situations such as the following:

- ▷ In road priority situations without "Give Way" signs, "Stop" signs or red light signal systems.
- ▷ At road junctions with relevant traffic lights that illuminate yellow or green.

Functional limitations

The system may have restricted functionality in situations such as the following:

- ▷ If road signs or light signal systems are unclear.
- ▷ If road signs or light signal systems are fully or partially concealed or soiled.
- ▷ If road signs or light signal systems are difficult to read or rotated.
- ▷ If road signs or light signal systems are too small or too large.
- ▷ With road signs that do not correspond to the standard.
- ▷ If road signs are detected that apply to a merging or parallel road.
- ▷ If the road signs or road layouts are specific to one country.
- ▷ At road junctions with flashing light signal systems.
- ▷ Up to 10 seconds after switching on drive-ready state using the Start/Stop button.
- ▷ In the case of navigation data that is invalid, outdated or not available.
- ▷ The system may not be available or may only be available to a limited extent in some countries.

Wrong-way Warning

Principle

The Wrong-way Warning issues a warning if the driver is about to drive the wrong-way, for example on motorways, roundabouts and one-way streets.

General

Depending on the equipment, the system will check the traffic situation based on navigation data and road signs.

The system will take into account road signs such as the following:

- ▷ No entry.
- ▷ Roundabout.
- ▷ Direction arrows: keep right/left signs.

Safety information

Follow the safety information in the Chapter "Collision warning systems".

Operating requirements

The road layout ahead must be unambiguously indicated by road signs.

Sensors

The system is controlled by the camera behind the windscreen.

Turning Wrong-way Warning on/off

Depending on the national-market version, the Wrong-way Warning is automatically activated after each start of the journey.

Warning function



A warning is displayed and an acoustic signal sounds, for example when the vehicle is travelling in the wrong direction on a motorway, roundabout or one-way street.

Warnings are displayed in the instrument cluster and, depending on the equipment, in the Head-up display.

System limits

General

Follow the limits of the system in the chapter "Collision warning systems".

No Warning

The system provides no warning if the road layout is not indicated by road signs, for example.

Functional limitations

The system may have restricted functionality, or give no Wrong-way Warning at all, in situations such as the following:

- ▷ If the road signs are ambiguous.
- ▷ If the road signs are fully or partially covered or soiled.
- ▷ If the road signs are poorly visible or twisted.
- ▷ If the road signs are too small or too large.
- ▷ With road signs that do not correspond to the standard.
- ▷ If road signs are detected that apply to a merging or parallel road.
- ▷ If the road signs or road layouts are specific to one country.
- ▷ Up to 10 seconds after switching on drive-ready state using the Start/Stop button.
- ▷ In the case of navigation data that is invalid, outdated or not available.
- ▷ It may not be possible to use the system in all countries.

Emergency Stop Assistant

Principle

If the driver can no longer drive the vehicle safely, the Emergency Stop Assistant helps to bring the vehicle to a safe standstill.

General

The Emergency Stop Assistant is activated automatically.

If the system is activated, the vehicle is brought to a standstill within its own lane by means of lane tracking.

Safety information

WARNING

The system does not relieve you of your personal responsibility to assess your physical condition correctly. Increasing inattention or fatigue might not be detected, or may not be detected in good time. There is a risk of accident. Make sure that the driver is rested and alert. Adapt your driving style to the traffic conditions.

Operating requirements

- ▷ Emergency Stop Assistant is activated via iDrive.
- ▷ The function is activated from a speed of approx. 70 km/h, approx. 43 mph.
- ▷ The Driver Attention Camera detects driver activity.

Activating the Emergency Stop Assistant

If the system detects that the driver is no longer driving the vehicle safely or is ignoring warnings, the Emergency Stop Assistant is activated automatically. The activated system is displayed in the instrument cluster.

The Emergency Stop Assistant can also be activated via voice input.

For further information:

BMW Intelligent Personal Assistant, see page 60.

An immediate emergency call can be triggered on the control display.

The following is performed automatically when the Emergency Stop Assistant is activated:

- ▷ A display is shown in the instrument cluster.
- ▷ The system takes control of the vehicle until the vehicle comes to a standstill.
- ▷ The hazard warning lights are switched on.
- ▷ Depending on the equipment, an emergency call is triggered at standstill.

Activating/deactivating the Emergency Stop Assistant

1.  Apps menu
2. "Vehicle"
3. "Driving settings"
4. "Driver assistance"
5. "Safety and warnings"
6. "Emergency stop"
7. Select the desired setting.

Cancelling the Emergency Stop Assistant

At any time during the process, the driver can cancel the Emergency Stop Assistant function by actively taking control of the vehicle.

For example, the system is cancelled in the following situations:

- ▷ With strong countersteering.
- ▷ On indicating.
- ▷ If the accelerator pedal is pressed hard.
- ▷ When the hazard warning lights are switched off.

- ▶ If the system is interrupted on the control display.
- ▶ When changing the selector lever position, if the vehicle was already at a standstill.

When the vehicle is at a standstill

As soon as the vehicle is at a standstill, the system configures the following settings:

- ▶ The vehicle is secured to prevent it from rolling away.
- ▶ The interior lights are switched on.
- ▶ The central locking system is unlocked.

Displays in the instrument cluster

Icon	Status
	Emergency Stop Assistant has triggered.



System limits

The system cannot replace the abilities of a safe driver.

The Emergency Stop Assistant may have restricted functionality in situations such as the following:

- ▶ If the Driver Attention Camera is covered by the steering wheel.
- ▶ If the driver is wearing sunglasses with high protection against infrared light.

Crossing-traffic Warning with brake function

Principle

At blind exits or when leaving bay parking spaces, the Crossing-traffic Warning detects other road users approaching from the side earlier than is possible from the driver's seat.

General

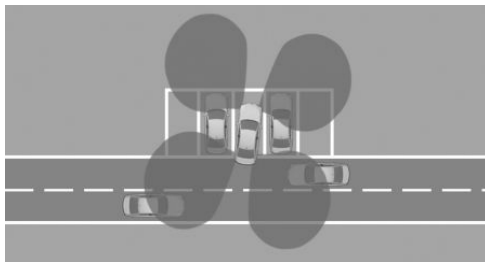

The area behind to the vehicle is monitored by sensors.

Depending on the equipment, the area in front of the vehicle is also monitored.

The system indicates when other road users are approaching.

In case of a risk of collision when driving in reverse, the system will provide assistance with an automatic brake intervention.

Follow the information in the Chapter "Parking assistance systems".

Safety information

WARNING

The system does not relieve you of your personal responsibility to assess the traffic situation correctly. Due to system limits, it cannot respond independently and appropriately in all traffic situations. There is a risk of accident. Adapt your driving style to the traffic conditions. Observe the traffic situation, be ready to take over steering and braking at any time, and actively intervene if the situation warrants it.

Sensors

The system is controlled using the following sensors:

- ▷ Side radar sensors, rear.
- ▷ Depending on the equipment: side radar sensors, front.

Activating/deactivating Crossing-traffic Warning

The system must be activated on the control display for the Crossing-traffic Warning and brake intervention to switch on automatically.

1.  Apps menu
2. "Vehicle"
3. "Driving settings"
4. "Driver assistance"
5. "Parking"
6. Depending on the equipment, select the desired setting:
 - ▷ "Rear warning"
 - ▷ "Front and rear warning"
 - ▷ "Brake intervention at rear"

Turning on the Crossing-traffic Warning automatically

The system must be activated on the control display. As soon as Park Distance Control or a camera view is active and a drive position is engaged, the system is automatically switched on.

The system is switched on at the rear when reverse gear is engaged.

Depending on the equipment, the front system is turned on when a drive position is engaged.

Depending on the national-market version, the system is automatically active when the vehicle is started.

Turning off the Crossing-traffic Warning automatically

The system is automatically turned off, for example, in the following situations:

- ▷ If walking speed is exceeded.
- ▷ When a certain distance covered is exceeded.

Warning function

General

The control display shows the corresponding image, an acoustic signal may sound, and the warning light in the exterior mirror flashes.

In case of a brake intervention, a message is displayed on the control display, which will be closed after a brief period of time.

Visual warning

Warning light in the exterior mirror



The warning light in the exterior mirror flashes if other vehicles are detected by the rear sensors when the vehicle is reversing.

Display in the Park Distance Control view

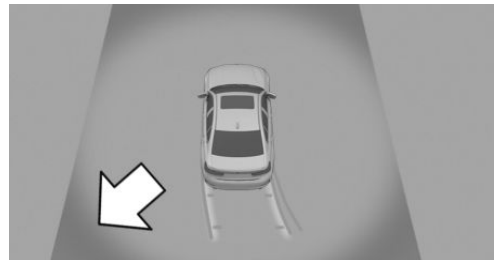

In the Park Distance Control view, the relevant boundary area flashes red if the sensors detect vehicles.

Display in the camera image

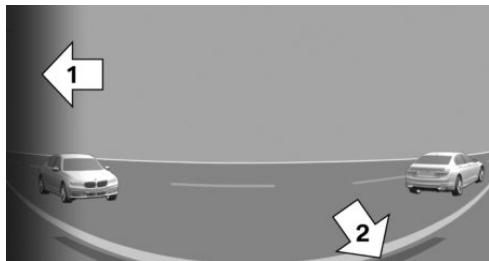

Depending on the direction of travel, the view to the front or rear is displayed in the camera image.

The relevant boundary area, arrow 1, in the camera view flashes red if the sensors detect vehicles.

Yellow lines, arrow 2, indicate the bumper of your vehicle.

Acoustic warning

In addition to the visual warning, an acoustic signal sounds if your own vehicle moves into the respective direction.

Depending on the national-market version, the acoustic signal will already sound when the drive position is engaged.

System limits

System limits of the sensors

For further information:

Sensors in the vehicle, see page 42.

Functional limitations

The function can be restricted, for example, in the following situations:

- ▷ In tight bends.
- ▷ Crossing objects are moving at a very slow or a very fast speed.

- ▷ Other objects that hide cross traffic are in the capture range of the sensors.
- ▷ If the trailer socket is occupied or trailer operation is activated, the Crossing-traffic Warning is not available for the area behind the vehicle.

Dynamic brake lights

Principle

The brake lights flash to warn road users behind the vehicle that emergency braking is being performed.

General



- ▷ Normal braking: brake lights illuminate.
- ▷ Heavy braking: brake lights flash.

Shortly before the vehicle comes to a standstill, the hazard warning lights are activated.

To switch off the hazard warning lights:

- ▷ Accelerate.
- ▷ Press the hazard warning lights button.

BMW Drive Recorder

Principle

The BMW Drive Recorder saves short video recordings of the vehicle surroundings in order to document the traffic situation, for example.

General

Video recordings can be saved in different ways:

- ▷ Automatic saving of recordings.
The function makes it possible to document the accident or theft of the vehicle with the corresponding recording type set.
- ▷ Manual saving of recordings.
The function makes it possible to document the traffic situation with the correspondingly set recording type.

The cameras of the assistance systems are used for recording, e.g. panorama view.

In addition, the following journey parameters are saved:

- ▷ Date.
- ▷ Time.
- ▷ Speed.
- ▷ GPS coordinates.

Data protection

The reliability of the recording and the use of video recordings depend on the legal regulations in the country where the system is to be used. The user is responsible for the use of the system and for complying with the provisions that apply in each case.

Before using for the first time, the vehicle manufacturer recommends checking that there are no legal or official restrictions on using the system in the state or country in question. Additionally, the legality of using the system should be checked at regular intervals, especially if the vehicle frequently crosses borders.

Other drivers of the vehicle must be informed of the system. Information about the system must also be provided if the vehicle is passed on to anyone else.

Operating requirements

- ▷ Standby state or drive-ready state is switched on.
- ▷ BMW Drive Recorder is activated.
- ▷ Privacy Policy has been accepted.
- ▷ Recording type was selected.
- ▷ Recording duration was selected.

Theft notification:

- ▷ The theft notification was activated in the Data Protection menu or in the Drive Recorder menu.
- ▷ Data transfer is activated.
- ▷ My BMW App is installed on the mobile device.
- ▷ My BMW App is linked with the Connected-Drive account.
- ▷ Privacy Policy has been accepted.

Activating/deactivating the BMW Drive Recorder

The BMW Drive Recorder must be activated before using the recording function for the first time.

1.  Apps menu
2. "All apps"
3. "Drive Recorder"
4. Accept data protection policy.
5. "Settings"
6. "Allow recording"
7. Select the desired setting.

Recording functions

Automatic recording

The recording is automatically saved when the vehicle sensors detect an accident or theft.

- ▷ In case of accident:



The system saves recordings up to 30 seconds before and after the save function was triggered.

▶ In case of theft:

Depending on the selected recording duration setting, the system saves the recording after it has been triggered.

When the alarm system is triggered, a message is sent to the My BMW App.

After saving the recording, a video in reduced quality can be downloaded to a mobile device.

If the vehicle accelerates rapidly, an automatic recording may occur.

Manual recording

Using the button

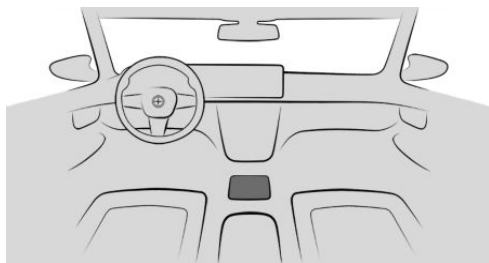

Press and hold the button.

Via iDrive

Start the recording:

1. Apps menu
2. "All apps"
3. "Drive Recorder"
4. "Recording"
5. "Start recording"

Stop the recording: "Stop recording".

The system saves recordings up to 30 seconds before and after the save function was triggered.

Playing and managing recordings

Saved video recordings can be played, exported and deleted.

For your own safety, the video recording is only shown on the control display if the speed is below approximately 3 km/h, 2 mph. In the case of some national-market versions, the video recording is only shown with the parking brake applied or with the selector lever in position P.

1. Apps menu
2. "All apps"
3. "Drive Recorder"
4. "Recordings"
5. Select the desired recording.
6. If necessary, select camera.

Settings

Recording type

1. Apps menu
2. "All apps"
3. "Drive Recorder"
4. "Settings"
5. Select the desired setting.

Recording duration

1. Apps menu
2. "All apps"
3. "Drive Recorder"
4. "Settings"
5. Select the desired setting.

Recording on a mobile device

Principle

Depending on the equipment, video recordings can be stored directly on a mobile device, for example a smartphone or USB storage.

General

The length of the video that can be stored depends on the available memory capacity on the mobile device.

Operating requirements

- ▶ Privacy Policy has been accepted.
- ▶ BMW Drive Recorder is activated.

To transfer recordings to a mobile device:

- ▶ Depending on the equipment version, a mobile device is connected to the vehicle via Wi-Fi and Bluetooth audio or a USB storage device is connected.
- ▶ My BMW App is installed on the mobile device.
- ▶ My BMW App is linked with the Connected-Drive account.

Recording

The recording can be started and stopped manually.

Start the recording:

1.  Apps menu
2. "All apps"
3. "Drive Recorder"
4. "Recording"
5. "Start recording"

Stop the recording: "Stop recording".

Cameras

Different cameras can be selected.

1.  Apps menu
2. "All apps"
3. "Drive Recorder"
4. "Settings"
5. "Cam. selection"
6. Select the desired camera.

System limits

In the event of a serious accident, recordings may not be saved if, for example, the damage to the vehicle is too extensive or the power supply was interrupted.

In the case of USB drives that have been overwritten multiple times, there may be limitations when exporting recordings.

NTFS is the preferred file system for USB storage devices. There may be limitations when using other file systems.

In case of theft, the recording is only stored automatically when the alarm system has been triggered.

Theft notification and video download may be restricted or unavailable if the Internet connection is weak or missing.

Saving the recordings on the smartphone depends on the quality of the Wi-Fi connection. The function may be restricted or unavailable if the connection is weak.

Active Protection

Principle

In critical situations, Active Protection prepares the passengers and the vehicle for a potential imminent accident.

General

Depending on the equipment and the national-market version, Active Protection consists of different PreCrash functions.

The system detects critical driving situations which could potentially lead to an accident. Such critical driving situations include:

- ▶ Full braking.
- ▶ Severe understeering.
- ▶ Severe oversteering.



Certain functions of some systems installed in the vehicle can – within the system limits – cause Active Protection to trigger:

- ▶ Front collision warning: automatic brake intervention.
- ▶ Front collision warning: brake power assistance.
- ▶ Rear collision warning: detects impending rear collisions.

Safety information

WARNING

The system does not relieve you of your personal responsibility. System limits may mean that critical situations are not detected reliably or in good time. There is a risk of accident. Adapt your driving style to the traffic conditions. Observe the traffic situation and intervene actively if the situation warrants it

Function

Depending on the equipment and requirements, in critical accident situations, the following individual functions become active as required:

- ▶ The windows are automatically closed.
The windows remain cracked open.
- ▶ Automatic closure of the sun protection.
- ▶ Automatic positioning of the backrest of the front passenger seat.

Following a critical driving situation where no accident has occurred, the systems can be restored to the desired setting.

PostCrash – iBrake

Principle

In certain accident situations, PostCrash iBrake can automatically bring the vehicle to a standstill without the driver having to intervene.

General

PostCrash iBrake can reduce the risk of another collision and its consequences.

At a standstill

Once the vehicle has come to a halt, the brake is released automatically.

Decelerating the vehicle harder

In certain situations, it may be necessary to bring the vehicle to a standstill more quickly than is possible with automatic braking of PostCrash – iBrake.

To do so, brake quickly and firmly. This will briefly increase the brake pressure to a higher level than that achieved with the automatic brake function. Automatic braking is interrupted.

Cancelling automatic braking

In certain situations, it may be necessary to cancel automatic braking, for example if an avoidance manoeuvre is required.

Cancel automatic braking:

- ▶ By depressing the brake pedal.
- ▶ By depressing the accelerator pedal.

Attentiveness Assistant

Principle

The break recommendation of Attentiveness Assistant can detect decreasing attentiveness or the onset of fatigue in the driver on long mo-

notonous journeys, for example on motorways. The system recommends taking a break.

Safety information

WARNING

The system does not relieve you of your personal responsibility to assess your physical condition correctly. Increasing inattention or fatigue might not be detected, or may not be detected in good time. There is a risk of accident. Make sure that the driver is rested and alert. Adapt your driving style to the traffic conditions.

Break recommendation

Function

Once the journey has started, the system adapts to the driver so that any decrease in attention or fatigue can be detected.

This process takes into account the following criteria, for example:

- ▷ Personal driving style, for example steering.
- ▷ Driving conditions, for example time of day, duration of journey.
- ▷ Depending on the equipment: attentiveness of the driver through the Driver Attention Camera.

The system is active from approx. 65 km/h, 40 mph and can also display a recommendation to take a break.

Setting break recommendations

The break recommendation can be switched on and off and set via iDrive.

1.  Apps menu
2. "Vehicle"
3. "Driving settings"
4. "Driver assistance"

5. "Safety and warnings"
6. "Attentiveness Assistant"
7. Select the desired setting.

Display

If the driver shows signs of decreasing attentiveness or of fatigue, a note is shown on the control display with the recommendation to take a break.

The following settings can be selected during the display.

The system is reset approximately 45 minutes after the vehicle is stopped. A break recommendation can only be displayed again after this time has elapsed.

System limits

The Attentiveness Assistant may be restricted. If the system is restricted, no warning or a false warning is issued.

The break recommendation function may have restricted functionality in the following situations:

- ▷ If the time is set incorrectly.
- ▷ When the speed is predominantly below approx. 65 km/h, 40 mph.
- ▷ If a sporty driving style is adopted, for example sharp acceleration or fast cornering.
- ▷ In active driving situations, for example frequent lane changes.
- ▷ In poor road condition.
- ▷ In strong crosswinds.

Driver Attention Camera

Principle

A camera in the instrument cluster monitors the driver activity and, depending on the equipment, the driver's direction of view.



General

For support by assistance systems, the attention of the driver is analysed by evaluating the head position and eye opening of the driver.

To guarantee full functionality, ensure that the Driver Attention Camera has an unobstructed field of view.

Overview

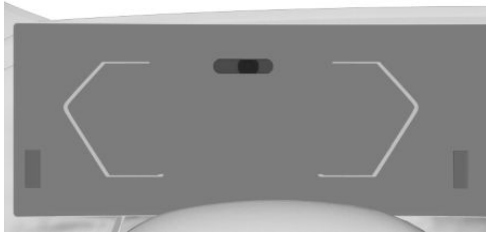

Depending on the equipment, the instrument cluster has up to three infrared light sources. Depending on the light conditions, these light sources can be visible when the vehicle is in the standby state.

System limits

The Driver Attention Camera may have restricted functionality in situations such as the following:

- ▷ If the Driver Attention Camera is covered by the steering wheel.
- ▷ If the driver is wearing sunglasses with high protection against infrared light.

Driving stability control systems

Vehicle equipment

This chapter describes equipment, systems and functions which are offered or may be offered in future on a model-specific basis, even if they are not included in the vehicle in question.

For further information:

Vehicle equipment, see page 8.

Anti-lock Braking System

Principle

The Anti-lock Braking System prevents the wheels from locking during braking.

Steering control is retained even during full braking, which enhances active road safety.

General

The Anti-lock Braking System is ready whenever you switch on drive-ready state.

Malfunction



The warning light in the instrument cluster is illuminated.

A Check Control message is shown.

- ▷ The Anti-lock Braking System (ABS) is not available.
- ▷ The ease of steering is restricted in the event of full braking.

Have the vehicle checked immediately by an authorised Service Partner or another qualified Service Partner or a specialist workshop.

Brake Assist

When the brake pedal is pressed quickly, Brake Assist automatically provides the maximum possible braking force assistance. This keeps the stopping distance as short as possible in full braking situations.

In order to use the full braking force assistance, do not reduce the pressure on the brake pedal during full braking.

Dynamic Stability Control

Principle

Dynamic Stability Control helps to keep the vehicle on a steady course in critical driving situations. The drive power is reduced depending on the situation and individual wheels can be braked.

General

The system detects the following unstable driving conditions, for example:

- ▷ Loss of traction at the rear which can lead to oversteering.
- ▷ Loss of grip at the front wheels which can lead to understeering.

Safety information

WARNING

The system does not relieve you of your personal responsibility to assess the traffic situation correctly. Due to system limits, it cannot respond independently and appropriately in all traffic situations. There is a risk of accident. Adapt your driving style to the traffic conditions. Observe the traffic situation, be

ready to take over steering and braking at any time, and actively intervene if the situation warrants it.

Overview

Button in the vehicle

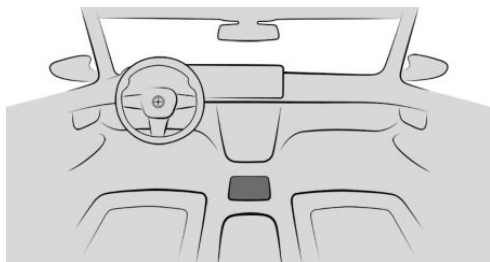

My Modes

Activating/deactivating Dynamic Stability Control

If Dynamic Stability Control is deactivated, driving stability is restricted when accelerating and cornering.

To support driving stability, reactivate Dynamic Stability Control as soon as possible.

1.  Press the button.
2. "Switch mode"
3. "SPORT"
4. "Settings"
5. "Driving dynamics"
6. "DSC OFF"

When changing to another drive mode, Dynamic Stability Control is activated automatically.

"SPORT": when you switch to this drive mode, the last setting is automatically reactivated.

Displays in the instrument cluster



Display when Dynamic Stability Control is deactivated.



Indicator light is illuminated: Dynamic Stability Control is deactivated.



Warning light pulsates: Dynamic Stability Control is regulating the driving power and brake forces. The vehicle is being stabilised. Decrease speed and adjust driving style to the road conditions.



Warning light is illuminated: Dynamic Stability Control has failed or is initialising. The driving stabilisation is restricted or has failed.

If the warning light is continuously illuminated, have the vehicle checked immediately by an authorised Service Partner or another qualified Service Partner or a specialist workshop.

Setting for increased driving dynamics

Principle

For a more dynamic driving experience, the vehicle can be adjusted to a setting for increased driving dynamics via My Modes.

General

The Dynamic Stability Control and thereby the driving stability are limited during acceleration and when cornering.

Overview

Button in the vehicle

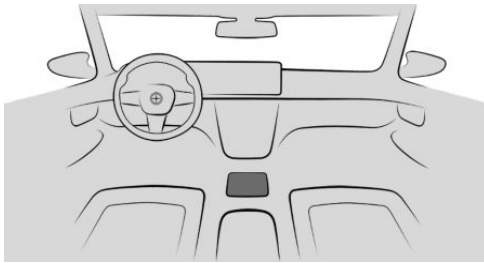

My Modes

Activating/deactivating increased driving dynamics

1.  Press the button.
2. "Switch mode"
3. "SPORT"
4. "Settings"
5. "Driving dynamics"
6. "SPORT PLUS"

When changing to another drive mode, Dynamic Stability Control is activated.

"SPORT": the last setting for the Dynamic Stability Control remains stored in this drive mode.

Display in the instrument cluster



The indicator light is illuminated: increased driving dynamics activated.

Automatic programme change

The increased driving dynamics will be deactivated automatically, for example in the following situations:

- ▷ When the distance control is activated.
- ▷ In case of a brake intervention by the front collision warning. Deactivate the front collision warning if necessary.
- ▷ If the suspension control system fails.
- ▷ In the event of a flat tyre.

For further information:

Front collision warning with brake intervention, see page 190

Drive-off support

Principle

The drive-off support offers the best possible traction when driving off in certain situations on difficult ground, for example snow or sand.

General

The function provides maximum propulsion with adapted driving stability in the low speed range.

Activating/deactivating the drive-off support

1.  Apps menu
2. "Vehicle"
3. "Driving settings"
4. "Drivetrain and chassis"
5. "Drive-off support"
6. "Activate once" or "Deactivate"

The drive-off support remains active until it is deactivated or the drive mode is changed.

BMW xDrive

Principle

BMW xDrive is the vehicle's all-wheel drive system. The interaction of BMW xDrive and other suspension control systems, for exam-

ple, Dynamic Stability Control, further optimises traction and driving dynamics.

General

BMW xDrive distributes the driving power variably to the front and rear axles according to the driving situation and road condition.

Integral Active Steering

Principle

The Integral Active Steering increases the manoeuvrability of the vehicle and makes a more direct steering response possible. Driving stability is also increased at high speeds.

General

The Integral Active Steering is a combination of the variable steering gear ratio of the front axle and the active rear-wheel steering.

The rear-wheel steering increases manoeuvrability at low speeds by turning the rear wheels slightly in the opposite direction to the front wheels.

At higher speeds, the rear wheels are turned in the same direction as the front wheels. The resulting benefits include smooth lane changes.

In critical driving situations, Integral Active Steering can stabilise the vehicle by automatically steering the rear wheels, for example when oversteering.

Setting

The system offers various settings.

With the drive modes of the My Modes, the system can be set to comfortable or dynamic.

For further information:

My Modes, see page [141](#).

Operation with snow chains

In order to guarantee freedom of movement of the wheels when operating with snow chains, rear-wheel steering must be turned off when snow chains are mounted.

For further information:

Rear-wheel steering with snow chains, see page [358](#).

Malfunction



The warning light in the instrument cluster is illuminated.

A Check Control message is shown.

The steering system may be faulty. The Integral Active Steering support may no longer be provided.

- ▶ Larger steering movements are required at low speeds.
- ▶ The response of the vehicle is more sensitive in higher speed ranges.
- ▶ Drive cautiously and think well ahead.

Have the system checked by an authorised Service Partner or another qualified Service Partner or a specialist workshop.

Driver assistance systems

Vehicle equipment

This chapter describes equipment, systems and functions which are offered or may be offered in future on a model-specific basis, even if they are not included in the vehicle in question.

For further information:

Vehicle equipment, see page 8.

Speed limit warning

Principle

The speed limit warning can be used to set a speed limit. A warning will be issued when this speed limit is exceeded.

General

The warning is repeated if the set speed limit is exceeded again after dropping below it by 5 km/h/3 mph.

Activating/deactivating the speed limit warning

1.  Apps menu
2. "Vehicle"
3. "Driving settings"
4. "Driver assistance"
5. "Safety and warnings"
6. "Speed warning"

Setting the speed

1.  Apps menu
2. "Vehicle"
3. "Driving settings"
4. "Driver assistance"

5. "Safety and warnings"
6. "Speed warning"
7. "Warning above:"
8. Select the desired setting.

Setting the current speed as the speed limit warning

1.  Apps menu
2. "Vehicle"
3. "Driving settings"
4. "Driver assistance"
5. "Safety and warnings"
6. "Speed warning"
7. "Adopt current speed"

Speed Limit Display with no-overtaking indicator

Speed Limit Info

Principle

Speed Limit Info shows the currently valid speed limit in the instrument cluster and, if necessary, the Head-up display and possibly supplementary signs.

General

The camera located near the interior mirror detects road signs at the edge of the road as well as variable overhead signs.

Depending on the national-market version, road signs with supplementary signs, for example, for wet road conditions, are taken into account and compared with the vehicle's on-board data, for example, the windscreen wiper signal. The road sign and associated supplementary signs are then displayed in the instru-

ment cluster and the Head-up display, if applicable, or ignored, depending on the situation. Some supplementary signs are taken into account in the speed limit evaluation, but are not displayed in the instrument cluster.

The system may also show speed limits that apply to routes that are not marked if the navigation system has current map data.

In order for Speed Limit Info to function correctly, the current map data must be installed for the country in which the vehicle is operated.

For information on the current map version and map update, see Map update in the chapter Navigation system.

If a navigation system is not installed, the system has certain technical limitations. Only road signs with speed limits are detected and displayed. Speed limits when driving into built-up areas and due to motorway signs, for example, are not displayed. Speed limits with text-based supplementary signs are always shown.

Speed limits for trailer operation are displayed when the trailer socket is occupied or when the trailer operation has been activated via iDrive.

Depending on the equipment, an approved maximum speed can be set up for trailer operation, which will be taken into account for the display of speed limits.

For further information:

- ▶ Owner's Handbook for Navigation, Entertainment, Communication, see page 6.
- ▶ Trailer operation, see page 330.

No-overtaking indicator

Principle

Overtaking restriction signs and end of restriction signs which have been detected by the camera are indicated by corresponding icons in the instrument cluster and, if applicable, the Head-up display.

General

The system considers overtaking restrictions and ends of restrictions that are indicated by means of road signs.

It will not display anything in the following situations:

- ▶ In countries where overtaking restrictions are primarily shown by road markings.
- ▶ On routes without road signs.
- ▶ In the case of railway crossings, lane markings and other situations which indicate an overtaking restriction but which are not signposted to this effect.

Depending on the equipment, an additional icon with distance information may also be displayed to indicate the end of the no-overtaking indicator.

Safety information

WARNING

The system does not relieve you of your personal responsibility to assess the traffic situation correctly. Due to system limits, it cannot respond independently and appropriately in all traffic situations. There is a risk of accident. Adapt your driving style to the traffic conditions. Observe the traffic situation, be ready to take over steering and braking at any time, and actively intervene if the situation warrants it.

Sensors

The system is controlled by the camera behind the windscreen.

Displaying Speed Limit Info

General

The Speed Limit Info can be shown or hidden via iDrive in the instrument cluster. Depending on the national-market version, Speed Limit

Info is continuously displayed in the instrument cluster.

Displaying Speed Limit Info



1.  Apps menu
2. "Vehicle"
3. "Driving settings"
4. "Driver assistance"
5. "Driving"
6. "Speed Limit Assistant"
7. "Speed limits"
8. "Show current limit"

Display



General

Depending on the national-market version, supplementary signs and no-overtaking indicators are displayed together with Speed Limit Info.









Speed Limit Info

Icon	Description
	Present speed limit.
	No data available on the current speed limit.
	Speed Limit Info unavailable.

No-overtaking indicator

Icon	Description
	No overtaking.
	End of overtaking restriction.

Supplementary signs

Icon	Description
	Speed limit with time limit.
	The speed limit only applies in wet conditions.
	The speed limit only applies in snow.
	The speed limit only applies in fog.
	The speed limit applies for the exit junction on the left.
	The speed limit applies for the exit junction on the right.
	The speed limit only applies when towing a trailer.
	Depending on the equipment: speed limit with unrecognised supplementary sign.

Speed Limit Display with Anticipatory Indicator

Depending on the equipment and national-market version, an additional icon with distance information may indicate that a change in speed limit is ahead. The Anticipatory Indicator must be activated for Speed Limit Assist.

Temporary speed limits may also be displayed, for example at construction sites. Temporary speed limits can only be displayed if

the following services are selected in the data protection menu for the navigation system:

- ▷ "Learning map"
- ▷ "Map update"

For further information:

- ▷ Speed Limit Assist, see page 253.
- ▷ Data protection, see page 74.

Warning signals

General

If the detected speed limit is exceeded or the speed limit is changed, the display flashes. Depending on the national-market version, an acoustic signal also sounds.

Signal when speeding

The warning if the maximum permissible speed is exceeded can be activated or deactivated via iDrive:

1.  Apps menu
2. "Vehicle"
3. "Driving settings"
4. "Driver assistance"
5. "Driving"
6. "Speed Limit Assistant"
7. "Warning when speeding"

SET

Depending on the national-market version, the visual and acoustic warning can be activated or deactivated via the SET button on the steering wheel.

Press and hold the button until a Check Control message is displayed.

Depending on the national-market version, the warning is automatically activated each time the vehicle is started for legal reasons.

Signal when the speed limit changes

The warning for change of speed limit can be activated or deactivated via iDrive:

1.  Apps menu
2. "Vehicle"
3. "Driving settings"
4. "Driver assistance"
5. "Driving"
6. "Speed Limit Assistant"
7. "Sound when speed limit changes."

Settings

1.  Apps menu
2. "Vehicle"
3. "Driving settings"
4. "Driver assistance"
5. "Driving"
6. "Speed Limit Assistant"
7. Select the desired setting.

System limits

System limits of the sensors

For further information:

- ▷ Camera, see page 42.

Functional limitations

Functionality may be restricted or incorrect information may be displayed in some situations such as:

- ▷ Road signs are fully or partially concealed by objects, stickers or paint.
- ▷ Road signs do not correspond to the standard.
- ▷ In areas that are not included in the map data of the navigation system.
- ▷ In the event of invalid, outdated or unavailable map data of the navigation system.

- ▶ If there are navigation discrepancies, for example due to changes in road layout.
- ▶ If the vehicle is too close to the vehicle ahead.
- ▶ When overtaking buses or trucks with road sign stickers.
- ▶ If there are electronic road signs.
- ▶ If road signs are detected that apply to a parallel road.
- ▶ If the road signs or road layouts are specific to one country.

Cruise Control Systems

Principle

The Cruise Control Systems provide support when driving.

General

Depending on the equipment, the Cruise Control Systems include the following individual systems.

- ▶ Manual Speed Limiter, see page 233.
- ▶ Cruise Control, see page 235.
- ▶ Distance control, see page 237.
- ▶ Assisted Driving Mode, see page 243.
- ▶ Assisted Driving Mode Plus, see page 250.

Depending on the equipment and national-market version, the individual systems are enhanced with additional functions.

Some functions can be operated via voice input.

For further information:

BMW Intelligent Personal Assistant, see page 60.

Safety information

WARNING

The system does not relieve you of your personal responsibility to assess the traffic situation correctly. Due to system limits, it cannot respond independently and appropriately in all traffic situations. There is a risk of accident. Adapt your driving style to the traffic conditions. Observe the traffic situation, be ready to take over steering and braking at any time, and actively intervene if the situation warrants it.

WARNING

Individual functions may malfunction when tow-starting or towing away with activated front collision warning or Cruise Control switched on. There is a risk of accident. Turn off the front collision warning and Cruise Control before tow-starting or towing away.

Overview

Buttons on the steering wheel

Button Function



Switch last active Cruise Control System on/off.

Interrupt and continue Cruise Control Systems.



Select the desired Cruise Control System.





Store the current speed.





Speed Limit Assist: accept the suggested speed manually.



To set the speed.

Turning on/selecting Cruise Control Systems

1.  Turn on: press the button.
2.  Select: when the system is active, press the button repeatedly until the desired Cruise Control System is displayed in the toolbar in the instrument cluster.

Icon	Cruise Control System
	Manual Speed Limiter.
	Cruise Control.
	Distance control.
	Assisted Driving Mode: Cruise Control with Distance Control, Steering Assistant with tracking.

The activated system is shown in green.
 The system is shown in white if the system can be activated.
 The system is greyed out if the system has failed or if the functional requirements are not met.



Interrupting Cruise Control Systems automatically

Depending on the system, Cruise Control Systems are interrupted automatically, for example, in the following situations:

- ▶ When exiting selector lever position D to P, N or R.
- ▶ When Dynamic Stability Control is regulating the driving stability.
- ▶ While Dynamic Stability Control is disabled.

- ▶ "SPORT PLUS": Setting for increased driving dynamics is activated.
- ▶ When braking manually.

Interrupting Cruise Control Systems manually

- ▶  Press the button.
- ▶  Press button to select another Cruise Control System.

Continuing Cruise Control Systems

- ▶  Press the key.

Turning off Cruise Control Systems automatically

The Cruise Control Systems turn off automatically when the drive-ready state is turned off.

Switching off Cruise Control Systems manually

- ▶  Press and hold the button.
 The Cruise Control Systems are turned off and the displays go out.

Adjusting speed values

- ▶  Press the rocker button on the steering wheel up or down repeatedly until the desired value is set.

- ▶ Each time the rocker button is tapped to the resistance point, the set speed is increased or decreased by 1 km/h, 1 mph.
- ▶ Each time the rocker button is pressed past the resistance point, the set speed changes to the next multiple of ten in the km/h display or the next multiple of five in the mph display in the speedometer.

Display in the instrument cluster

Display in the speedometer



A mark is displayed on the speedometer for the set speed.

- ▶ Green marker: system is active.
 - ▶ Grey mark: the system is interrupted.
- ▶ No marker: system is switched off.

Notifications

In addition to the respective indicator lights, notifications are displayed for some functions. The scope of notifications can be set.

1.  Apps menu
2. "Vehicle"
3. "Driving settings"
4. "Driver assistance"
5. "Driving"
6. "Notifications"
7. Select the desired setting.

Manual Speed Limiter

Principle





The Manual Speed Limiter can be used to set a speed limit, for instance to prevent the vehicle from exceeding speed limits.

General

The system allows speeds of 30 km/h/20 mph and above to be set as a speed limit. Below the set speed limit, the vehicle can be driven without restriction.



Overview

Buttons on the steering wheel

Button	Function
	Switch last active Cruise Control System on/off.
	Interrupt and continue Cruise Control Systems.
	Select the desired Cruise Control System.
	Store the current speed. Speed Limit Assist: accept the suggested speed manually.
	To set the speed.

Operation

Switching on the speed limiter

1.  If necessary, press the button.
2.  If necessary, press the button repeatedly until the speed limiter is selected.

The current speed or a higher speed that has already been stored is adopted as the speed limit.

When switching on at a standstill or driving at low speed, 30 km/h/20 mph is set as the speed limit.

The speedometer marker is set to the appropriate speed.

When the speed limit is switched on, the drive mode may be changed or Dynamic Stability Control activated.

Turning the Cruise Control System on/off

The Cruise Control System can be turned off or cancelled automatically or manually.

For further information:

Cruise Control Systems, see page 231.

Changing the speed limit



Press the rocker button repeatedly up or down until the desired speed limit is set.

If the set speed limit is reached or unintentionally exceeded, for example when driving downhill, there is no active brake intervention.

When Speed Limit Assist is not active, the current speed can be stored by pressing a button:



Press the button.

Exceeding of speed limit

The system gives a warning if the current speed exceeds the set speed limit.

You can intentionally exceed the speed limit.

To intentionally exceed the set speed limit, press the accelerator pedal all the way down.

The limit automatically becomes active again as soon as the current speed falls below the set speed limit.

Warning when the speed limit is exceeded

Visual warning



The indicator light in the instrument cluster flashes as long as the vehicle is travelling above the set speed limit.

Acoustic warning

- ▷ A warning sounds if you inadvertently exceed the set speed limit.
- ▷ If the speed limit is reduced to below the current speed during the journey, the signal sounds after a little time.
- ▷ No signal sounds if you intentionally exceed the speed limit by fully pressing the accelerator pedal.



Displays in the instrument cluster

Display in the speedometer



- ▷ Green marker: system is active.
- ▷ Grey mark: the system is interrupted.
- ▷ No marker: system is switched off.

Indicator light

Icon	Description
	Indicator light illuminates: the system is switched on. Indicator light flashes: set speed limit is exceeded.
	Grey indicator light: the system is interrupted.

Displays in the Head-up display

Depending on the equipment, some system information can also be displayed in the Head-up display.

Cruise Control

Principle

Cruise Control allows a set speed to be specified using the buttons on the steering wheel. The set speed is then maintained by the system. It does this by automatically accelerating and braking the vehicle as necessary.

General

The system can be activated starting at 30 km/h/20 mph.

Depending on the vehicle setting, the characteristics of Cruise Control may change in certain areas; for example, acceleration may change depending on the drive mode.

Safety information

WARNING

The system does not relieve you of your personal responsibility to assess the traffic situation correctly. Due to system limits, it cannot respond independently and appropriately in all traffic situations. There is a risk of accident. Adapt your driving style to the traffic conditions. Observe the traffic situation, be ready to take over steering and braking at any time, and actively intervene if the situation warrants it.

WARNING

The risk of accident may increase if the system is used in certain situations, such as:

- ▷ On stretches of road with many corners and bends.
- ▷ In heavy traffic.
- ▷ If the road is icy, if there is fog or snow, in wet conditions or on a loose road surface.

There is a risk of accident or material damage. Only use the system if it is possible to drive at a constant speed.

WARNING

The set speed may be set incorrectly by mistake or called up accidentally. There is a risk of accident. Adjust the set speed to the traffic conditions. Observe the traffic situation and intervene actively if the situation warrants it

Overview

Buttons on the steering wheel

Button Function



Switch last active Cruise Control System on/off.

Interrupt and continue Cruise Control Systems.



Select the desired Cruise Control System.



Store the current speed.

Speed Limit Assist: accept the suggested speed manually.



To set the speed.



Turning on the Cruise Control

In vehicles with distance control: change the mode of the Cruise Control to Cruise Control without distance control.

For further information:

Distance control, see page [237](#).

In vehicles without distance control: turn on the Cruise Control with the buttons on the steering wheel.

1.  If necessary, press the button.
2.  If necessary, press the button repeatedly until the Cruise Control is selected.

Cruise Control is active. The current speed is maintained and stored as the set speed.

The indicator lights are illuminated in the instrument cluster and the marker in the speedometer is positioned at the current speed.

When Cruise Control is switched on, the drive mode may be changed or Dynamic Stability Control activated.

Turning the Cruise Control System on/off

The Cruise Control System can be turned off or cancelled automatically or manually.

For further information:

Cruise Control Systems, see page 231.

Setting the speed

To maintain/store the speed

 While the system is interrupted, press the rocker button up or down once.

When the system is switched on, the current speed is maintained and stored as the set speed.

The stored speed is displayed on the speedometer.

When Speed Limit Assist is not active, the current speed can also be stored by pressing a button:

 Press the button.

Changing the speed

 Press the rocker button repeatedly up or down until the set speed is set.

If the system is active, the displayed speed is stored and the vehicle adjusts to the stored speed when the road is clear.

The maximum speed which can be set depends on the vehicle.

Press and hold the rocker button to the resistance point: the vehicle accelerates or decelerates without the need to press the accelerator pedal.

When the rocker button is released, the vehicle maintains the final speed. Pressing beyond the resistance point accelerates the vehicle more rapidly.

Resuming Cruise Control

With the stored speed

WARNING

The set speed may be set incorrectly by mistake or called up accidentally. There is a risk of accident. Adjust the set speed to the traffic conditions. Observe the traffic situation and intervene actively if the situation warrants it

If Cruise Control is interrupted, it can be resumed by calling up the stored speed. The difference between the current speed and saved speed should be as small as possible.

 With the system interrupted, press the button.

Cruise Control is resumed with the stored values.

In the following instances, the stored speed value is deleted and therefore cannot be called up again:

- ▶ When the system is switched off.
- ▶ When the drive-ready state is switched off.

At the current speed



Press the rocker button up or down to resume cruise control at the current speed.

Speed Limit Assist: at the suggested speed



When a speed is suggested, press the button to accept the Cruise Control at the suggested speed.

Displays in the instrument cluster

Display in the speedometer



- ▶ Green marker: system is active, the marker shows the set speed.
- ▶ Grey marker: system is interrupted; the marker shows the stored speed.
- ▶ No marker: system is switched off.

Indicator light



Green indicator light: the system is active.

Displays in the Head-up display

Depending on the equipment, some system information can also be displayed in the Head-up display.

System limits

The set speed is also maintained when driving downhill. The vehicle may not achieve the set speed on uphill gradients if there is not enough drive power.

Depending on the drive mode, it is possible that the vehicle will drive faster or slower than the set speed setting in some situations; for example, on downhill or uphill gradients.

Distance Control

Principle

With the distance control, a distance to a vehicle driving ahead can be set in addition to the Cruise Control.

General

When the road ahead is clear, the system maintains the set speed. The vehicle accelerates or brakes automatically.

If there is a vehicle driving in front, the system adapts the speed of your vehicle in order to maintain the set distance from the vehicle ahead. The speed is adapted as far as the given situation allows.

The distance can be set in several stages and for safety reasons is dependent on the respective speed.

If the vehicle ahead brakes to a standstill and drives off again shortly afterwards, the system is able to comprehend this as far as given conditions allow.

Otherwise, independent drive-off, for example, by stepping on the accelerator pedal or by pressing the button for the speed setting on the steering wheel.

Safety information

WARNING

The system does not relieve you of your personal responsibility to assess the traffic situation correctly. Due to system limits, it cannot respond independently and appropriately in all traffic situations. There is a risk of accident. Adapt your driving style to the traffic conditions. Observe the traffic situation, be ready to take over steering and braking at any time, and actively intervene if the situation warrants it.

⚠ WARNING

An unsecured vehicle can start moving and roll away. There is a risk of accident. Before leaving the vehicle, secure it in order to prevent it from rolling away.

Observe the following to ensure that the vehicle is secured against rolling away:

- ▷ Apply the parking brake.
- ▷ Turn the front wheels towards the kerb on uphill or downhill gradient.
- ▷ Additionally secure the vehicle on uphill or downhill gradient, for example with a chock.

⚠ WARNING

The set speed may be set incorrectly by mistake or called up accidentally. There is a risk of accident. Adjust the set speed to the traffic conditions. Observe the traffic situation and intervene actively if the situation warrants it

⚠ WARNING





There is a risk of accident if the difference in speed relative to other vehicles is too great. This may occur, for example, in the following situations:

- ▷ When quickly approaching a slowly moving vehicle.
- ▷ If another vehicle suddenly veers into the vehicle's own driving lane.
- ▷ When quickly approaching stationary vehicles.

There is a danger of injury or danger to life. Observe the traffic situation and intervene actively if the situation warrants it

Overview

Buttons on the steering wheel

Button	Function
	Switch last active Cruise Control System on/off. Interrupt and continue Cruise Control Systems.
	Select the desired Cruise Control System.
	Store the current speed. Speed Limit Assist: accept the suggested speed manually.
	To set the speed.

Sensors

The system is controlled using the following sensors:

- ▷ Camera behind the windscreen.
- ▷ Front radar sensor.

For further information:

Sensors in the vehicle, see page 42.

Use



The system can be used to optimum effect on well-constructed roads.

The maximum speed which can be set is limited and depends on the vehicle and its equipment, for example.

Depending on the equipment, higher set speeds can also be selected after switching to Cruise Control without Distance Control.

The system can also be activated when the vehicle is at a standstill.

Turning on Cruise Control with distance control

-  If necessary, press the button.
-  If necessary, press the button repeatedly until distance control is selected.

Cruise Control with Distance Control is active. The current speed is maintained and stored as the set speed.

The selected distance to a vehicle driving in front is maintained.

The indicator lights are illuminated in the instrument cluster and the marker in the speedometer is positioned at the current speed.

When Distance Control is switched on, the drive mode may be changed or Dynamic Stability Control activated.

Setting the speed

The speed can be set with the rocker button on the steering wheel.

For further information:

Cruise Control, see page [235](#).

Interrupting Cruise Control with distance control automatically

The system is automatically disrupted in situations such as the following:

- ▶ When braking manually.
- ▶ Selector lever position D is disengaged.
- ▶ While Dynamic Stability Control is disabled.
- ▶ "SPORT PLUS": Setting for increased driving dynamics is activated.
- ▶ When Dynamic Stability Control is regulating the driving stability.
- ▶ Driver's seat belt and driver's door are opened.
- ▶ The system has not detected any objects for an extended period, for example, on a

road with very little traffic without curb or shoulder markings.

- ▶ The detection range of the radar is impaired, for example, by contamination or heavy precipitation.
- ▶ After an extended stationary period, if the vehicle was decelerated to a standstill by the system.

Turning the Cruise Control System on/off

The Cruise Control System can be turned off or cancelled automatically or manually.

For further information:

Cruise Control Systems, see page [231](#).

Resume cruise control, while driving

WARNING

The set speed may be set incorrectly by mistake or called up accidentally. There is a risk of accident. Adjust the set speed to the traffic conditions. Observe the traffic situation and intervene actively if the situation warrants it

If Cruise Control is interrupted, it can be resumed by calling up the stored speed. The difference between the current speed and saved speed should be as small as possible.

For further information:

Cruise Control, see page [235](#).

Resume cruise control, when the vehicle is stationary

In certain situations, the system requires a moving-off confirmation by the driver.

The displays show the following:



The marking in the speedometer is illuminated grey.



The indicator light illuminates green.

Cruise control can be continued by the following actions:

- ▷ Pressing the accelerator pedal.



- ▷ Press the rocker button on the left side of the steering wheel.



- ▷ Press the button on the left side of the steering wheel.

Distance

Safety information



WARNING

The system does not relieve you of your personal responsibility. System limits may mean that deceleration is performed too late. There is a risk of accident or material damage. Pay close attention to the traffic situation at all times. Adapt the distance to suit traffic and weather conditions and comply with the prescribed safe distance by braking if necessary.

Adjusting the distance

1. Apps menu
2. "Vehicle"
3. "Driving settings"
4. "Driver assistance"
5. "Driving"
6. "Distance control"
7. "Distance"
8. Select the desired setting.

Adapting the distance automatically

Depending on the equipment and national-market version: the system can be configured

so that the distance to the vehicle in front is adapted automatically. The system takes into account the traffic situation and ambient conditions, e.g. poor visibility.

1. Apps menu
2. "Vehicle"
3. "Driving settings"
4. "Driver assistance"
5. "Driving"
6. "Distance control"
7. "Situational distance control"

Switching between Cruise Control with/without distance control

Safety information



WARNING

The system will not respond to traffic traveling in front of you, but instead maintains the stored speed. There is a risk of accident or material damage. Adjust the set speed to the traffic conditions and brake if necessary.

Switching the Cruise Control mode

Turning Cruise Control without distance control on or off:

1. Apps menu
2. "Vehicle"
3. "Driving settings"
4. "Driver assistance"
5. "Driving"
6. "Distance control"
7. "Switch to cruise control"

The setting is reset when the vehicle is parked.

Displays in the instrument cluster

General

Depending on the equipment, the displays in the instrument cluster may vary.





Display in the speedometer



- ▷ Green marker: system is active, the marker shows the set speed.
- ▷ Grey marker: system is interrupted; the marker shows the stored speed.

- ▷ No marker: system is switched off.

Indicator lights and warning lights

Icon	Description
	White indicator light: No Distance Control because the accelerator pedal is being pressed.
	The indicator light is illuminated green: Vehicle ahead detected. The vehicle symbol goes out if no vehicle in front is detected. The indicator light flashes green: The vehicle in front has started.
	The indicator light flashes grey: The requirements for system operation are no longer being met. The system has been deactivated but will continue to brake until you actively take over by depressing the brake or accelerator pedal.
	Warning light flashes red and an acoustic signal sounds: Brake and take avoidance manoeuvre if necessary.

Assisted View

Depending on vehicle equipment and national-market version, the information from the system in Assisted View is displayed in the central display area of the instrument cluster.

For further information:

Assisted View, see page 165.

Displays in the Head-up display

Set speed

Depending on the equipment, some system information can also be displayed in the Head-up display.

Distance information



The icon is shown if your vehicle is too close to the vehicle ahead.

The distance information is active under the following circumstances:

- ▷ Cruise Control with distance control switched off.
- ▷ Display in the Head-up display selected. Head-up display, see page 150.
- ▷ Distance too close.
- ▷ Speed above approximately 70 km/h, 40 mph.

Preventing overtaking

Depending on the equipment and national-market version, the function assists in avoiding unintended overtaking on motorways.

The system can be set to avoid overtaking in the slower lane.

The setting applies to speeds exceeding 80 km/h/50 mph.

When the set speed is significantly higher than the speed in the adjacent lane, passing or overtaking may still be possible even if the function is switched on.

At speeds below 80 km/h/50 mph, vehicles on motorways are only overtaken with an adjusted differential speed.

The driver can overtake or accelerate at any time by pressing the accelerator pedal.

Switching the function on/off:

1.  Apps menu
2. "Vehicle"
3. "Driving settings"
4. "Driver assistance"
5. "Driving"
6. "Distance control"
7. Depending on the national-market version:
 - ▷ "Avoid overtaking on the left"
 - ▷ "Avoid overtaking on the right"

System limits

System limits of the sensors

For further information:

- ▷ Cameras, see page 42.
- ▷ Radar sensors, see page 43.

Detection range

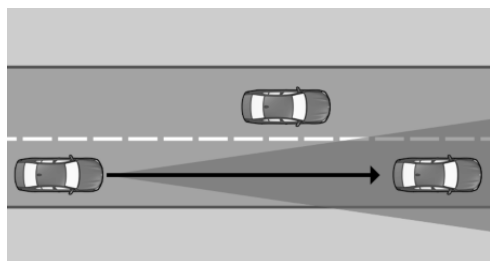

Sensors detect the traffic situation in their detection range.

The system's detection capability and automatic braking capacity are limited.

For example, two-wheel vehicles may not be detected.

Deceleration

The system does not decelerate in the following situations:

- ▷ For pedestrians or similarly slow road users.
- ▷ Depending on the equipment, at red traffic lights.
- ▷ For crossing traffic.
- ▷ For oncoming vehicles.

Vehicles cutting in

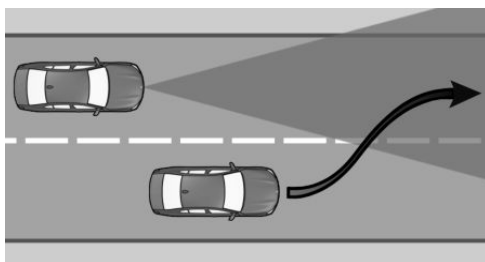

If another vehicle suddenly cuts in front of you, the system might not be able to restore the selected distance automatically. In some circumstances, it may also not be possible to restore the selected distance if you are driving significantly faster than vehicles in front, for example when rapidly approaching a lorry. If a vehicle is clearly detected in front of you, the system prompts you to intervene by braking, and if necessary by taking avoidance manoeuvre.

Cornering

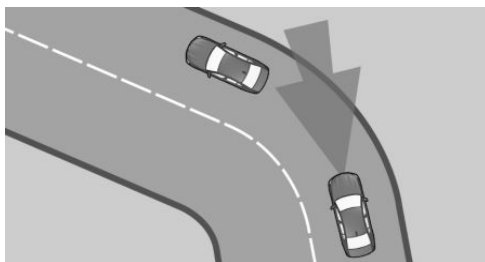

If the set speed is too high for cornering, it will be reduced slightly in the bend. However, since

bends may not be anticipated in advance, moderate your speed when cornering.

The system has a restricted detection range. Situations can arise on tight bends where a vehicle driving in front will not be detected or will be detected very late.

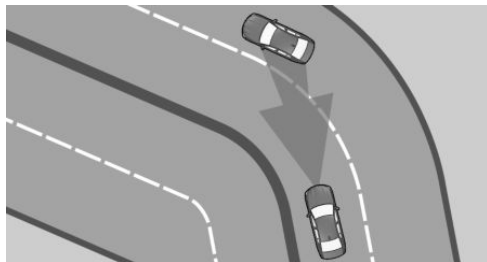

When your vehicle is approaching a bend, the curvature may cause the system to respond temporarily to vehicles in the other lane. If the system responds by decelerating the vehicle, you may compensate for this by accelerating briefly. When the accelerator pedal is released again, the system will resume control of the vehicle's speed.

Driving off

The vehicle cannot drive off automatically in some situations, for example:

- ▶ On steep upward gradients.
- ▶ Before bumps or rises in the road.
- ▶ When towing a heavy trailer.

In such cases, press the accelerator pedal.

Weather

In adverse weather and lighting conditions, system functionality may be limited as follows:

- ▶ Impaired detection of vehicles.
- ▶ Brief interruptions when vehicles have already been detected.

Pay attention when driving and respond to the prevailing traffic situation. If necessary, intervene actively, for example by braking, steering or taking avoidance manoeuvre.

Drive power

The set speed is also maintained when driving downhill. The vehicle may not achieve the set speed on uphill gradients if there is not enough drive power.

Depending on the drive mode, it is possible that the vehicle will drive faster or slower than the set speed setting in some situations; for example, on downhill or uphill gradients.

Assisted Driving Mode

Principle

Assisted Driving Mode enhances Distance Control with a Steering Assistant with tracking. The system helps the driver keep the vehicle in the driving lane. It does this by performing supporting steering wheel movements, for example when cornering.

General

Depending on the speed, the system orientates itself using the lane markings and vehicles driving in front.

Sensors in the steering wheel detect whether the steering wheel is being touched.

Depending on vehicle equipment and national-market version, the Driver Attention Camera on the instrument cluster monitors the driver's alertness.

Safety information

WARNING

The system does not relieve you of your personal responsibility to assess the traffic situation correctly. Due to system limits, it cannot respond independently and appropriately in all traffic situations. There is a risk of accident. Adapt your driving style to the traffic conditions. Observe the traffic situation, be ready to take over steering and braking at

any time, and actively intervene if the situation warrants it.

The information on Cruise Control and Distance Control also applies.

For further information:

- ▷ Cruise Control, see page 235.
- ▷ Distance control, see page 237.

Overview

Buttons on the steering wheel

Button	Function
	Switch last active Cruise Control System on/off. Interrupt and continue Cruise Control Systems.
	Select the desired Cruise Control System.
	Store the current speed. Speed Limit Assist: accept the suggested speed manually.
	To set the speed.



Switch last active Cruise Control System on/off.
Interrupt and continue Cruise Control Systems.



Select the desired Cruise Control System.



Store the current speed.
Speed Limit Assist: accept the suggested speed manually.



To set the speed.

Sensors

The system is controlled using the following sensors:

- ▷ Camera behind the windscreen.
- ▷ Front radar sensor.
- ▷ Depending on the equipment: Side radar sensors, front.
- ▷ Depending on the equipment: Side radar sensors, rear.
- ▷ Sensors in the steering wheel.
- ▷ Depending on vehicle equipment and national-market version: Driver Attention Camera

For further information:



- ▷ Sensors in the vehicle, see page 42.
- ▷ Driver Attention Camera, see page 221.

Operating requirements

- ▷ Depending on the equipment: speed below 210 km/h, approx. 130 mph or 180 km/h, approx. 110 mph.
- ▷ The lane width is sufficiently wide.
- ▷ Hands on the steering wheel rim.
- ▷ Sufficiently wide curve radius.
- ▷ Driving in the centre of the driving lane.
- ▷ The sensor system calibration process is complete.
- ▷ Distance control is active.
- ▷ Seat belt on the driver's side fastened.
- ▷ Front collision warning is active.
- ▷ Depending on the equipment: Side collision warning is active.
- ▷ With a trailer tow hitch: operation with a trailer or operation with a rear carrier must be set on the control display in accordance with the use.

Driving with a trailer or rear carrier, see page 333.

Switching on Assisted Driving Mode

1.  If necessary, press the button.
2.  If necessary, press the button repeatedly until Assisted Driving Mode is selected.

 The indicator light is illuminated grey.
System is on standby and does not make any steering wheel movement.

The system activates automatically when all operating requirements are met.



The indicator light illuminates green.
The system is activated and assists in keeping the vehicle in the driving lane.

When the system is switched on, the front collision warning and, depending on the equipment, the side collision warning are active.

Interrupting Assisted Driving Mode automatically

The system interrupts the supporting steering movements automatically, for example in the following situations:

- ▶ Depending on the equipment: at a speed above 210 km/h, approx. 130 mph or 180 km/h, approx. 110 mph.
- ▶ After releasing the steering wheel.
- ▶ When the steering wheel is turned sharply.
- ▶ When the vehicle leaves its own driving lane.
- ▶ When the turn signal indicator is activated or, depending on vehicle equipment, when the driver turns the steering wheel while the turn indicator is activated.
- ▶ When the driving lane is too narrow.
- ▶ A lane boundary is not detected and there is no vehicle driving in front.
- ▶ The Cruise Control with distance control is interrupted.
- ▶ The seat belt on the driver's side is unfastened.



The indicator light is illuminated grey.
System is on standby and does not make any steering wheel movement.

The system activates automatically when all operating requirements are met.

Displays in the instrument cluster

Icon	Description
	The indicator light is illuminated grey: The system is ready.
	The indicator light is illuminated green: The system is activated. The system is helping the driver keep the vehicle in the driving lane.
	The warning light flashes yellow and the steering wheel vibrates: A lane boundary has been crossed.
	The warning light is illuminated yellow and a signal sounds: A system interruption is imminent.
	Warning light flashes red and an acoustic signal sounds: The system is switching off or an interruption of the system is imminent.

Icon Description

 The warning light is illuminated yellow:
 Hands are not holding the steering wheel. System remains active.
 Grab the steering wheel with your hands.

 The warning light is illuminated red, a signal sounds:

 Hands are not gripping the steering wheel or, depending on vehicle equipment and national-market version, the driver is not looking toward traffic. A system interruption is imminent.

The system reduces the speed to a standstill if applicable.

The system may possibly not perform any supporting steering wheel movements.

Immediately place both hands on the steering wheel and pay attention to the traffic situation.

Depending on vehicle equipment and national-market version, a Check Control message is displayed if the Driver Attention Camera detects that the driver is not paying attention.

Depending on vehicle equipment and national-market version, the information from the system in Assisted View is displayed in the central display area of the instrument cluster.

For further information:
 Assisted View, see page [165](#).

Displays on the steering wheel

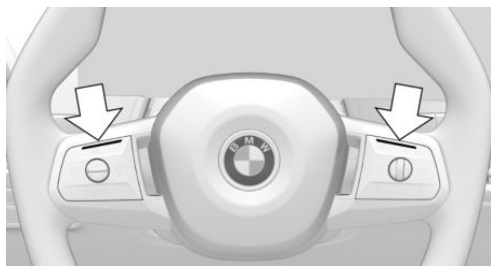

The two LEDs above the keypads illuminate analogously to the displays in the instrument cluster.

The steering wheel displays can be switched on/off if required.

1.  Apps menu
2. "Vehicle"
3. "Driving settings"
4. "Driver assistance"
5. "Feedback via steering wheel"
6. "Lighting elements"
7. Select the desired setting.

Displays in the Head-up display

Depending on the equipment, the system information can also be displayed in the Head-up display.

Adjusting the strength of the steering wheel vibration

1.  Apps menu
2. "Vehicle"
3. "Driving settings"
4. "Driver assistance"
5. "Feedback via steering wheel"
6. "Vibration intensity"
7. Select the desired setting.

The setting is applied to all Intelligent Safety Systems.

System limits

General

This system cannot be activated or utilised appropriately in certain situations, e.g., when using a trailer.

Safety information

WARNING

Due to system limitations, the system may not respond at all, or may respond too late, incorrectly or for no reason. There is a risk of accident or material damage. Observe the information on the system limits and intervene actively if necessary.

The information on Cruise Control and Distance Control also applies.

For further information:

- ▷ Cruise Control, see page [235](#).
- ▷ Distance Control, see page [237](#).

System limits of the sensors

For further information:

- ▷ Cameras, see page [42](#).
- ▷ Radar sensors, see page [43](#).
- ▷ Driver Attention Camera, see page [221](#).

Hands on the steering wheel

In the following situations, contact between the driver's hands and the steering wheel is not detected by the sensors:

- ▷ Driving when wearing gloves.
- ▷ Covers on the steering wheel.

Weather

In adverse weather and lighting conditions, system functionality may be limited as follows:

- ▷ Impaired detection of vehicles and lane markings.
- ▷ Short-term interruptions in case of already detected vehicles and lane boundaries.

Pay attention when driving and respond to the prevailing traffic situation. If necessary, intervene actively, for example by braking, steering or taking avoidance manoeuvre.

Emergency Lane Assistant

Principle

The Emergency Lane Assistant can assist in traffic queues on motorways or motorway-like roads with the formation of an emergency lane.

General

As soon as the system detects a traffic queue, a Check Control message is shown on the control display. Depending on the situation, the vehicle will be steered to the right or left within the current driving lane in order to form an emergency lane.

The system uses the Assisted Driving Mode sensors.

Safety information

WARNING

The system does not relieve you of your personal responsibility to assess the traffic situation correctly. Due to system limits, it cannot respond independently and appropriately in all traffic situations. There is a risk of accident. Adapt your driving style to the traffic conditions. Observe the traffic situation, be ready to take over steering and braking at any time, and actively intervene if the situation warrants it.

The Assisted Driving Mode notices also apply.

For further information:

Assisted Driving Mode, see page [243](#).

Operating requirements

- ▶ Assisted Driving Mode is activated.
Assisted Driving Mode, see page [243](#).
- ▶ Traffic queue is detected.
- ▶ Driving on a motorway or a similar road.
- ▶ Lane boundary is detected.
- ▶ The function must be available in the country in which the vehicle is being driven.
- ▶ With a trailer tow hitch: operation with a trailer or operation with a rear carrier must be set on the control display in accordance with the use.
Driving with a trailer or rear carrier, see page [333](#).

Activating/deactivating the Emergency Lane Assistant

Depending on the equipment and national-market version, the Emergency Lane Assistant can be deactivated.

1.  Apps menu
2. "Vehicle"
3. "Driving settings"
4. "Driver assistance"
5. "Driving"
6. "Assisted Driving"
7. "Emerg. Corridor Assistant"

Displays in the instrument cluster

Depending on vehicle equipment and national-market version, the information from the system in Assisted View is displayed in the central display area of the instrument cluster.

For further information:

Assisted View, see page [165](#).

System limits

The limits of the Assisted Driving Mode system apply.

For further information:

Assisted Driving Mode, see page [243](#).

Lane Change Assistant

Principle

The Lane Change Assistant also assists when changing lanes on multi-lane roads.

General

The system uses the Assisted Driving Mode sensors.

Safety information

WARNING

The system does not relieve you of your personal responsibility to assess the traffic situation correctly. Due to system limits, it cannot respond independently and appropriately in all traffic situations. There is a risk of accident. Adapt your driving style to the traffic conditions. Observe the traffic situation, be ready to take over steering and braking at any time, and actively intervene if the situation warrants it.

The Assisted Driving Mode notices also apply.

For further information:

Assisted Driving Mode, see page [243](#).

Operating requirements

- ▶ The functional requirements for Assisted Driving Mode are met.
Assisted Driving Mode, see page [243](#).
- ▶ Driving on a road without pedestrians or cyclists and with physical barriers separating

oncoming vehicles, for example crash barriers.

- ▷ Since the start of the journey, a vehicle has been detected at a sufficient distance behind your own vehicle.
- ▷ Lane boundaries that can be driven over are detected.
- ▷ Maximum speed 180 km/h, approx. 110 mph.
- ▷ The minimum speed is country-specific.
- ▷ With a trailer tow hitch: operation with a trailer or operation with a rear carrier must be set on the control display in accordance with the use.

Driving with a trailer or rear carrier, see page 333.

Turning on/turning off Lane Change Assistant

1.  Apps menu
2. "Vehicle"
3. "Driving settings"
4. "Driver assistance"
5. "Driving"
6. "Assisted Driving"
7. "Lane Change Assistant"

Depending on the equipment and national-market version, settings can be made for the Lane Change Assistant.

Changing driving lane

1. Ensure that the traffic situation permits a lane change.
2. Initiate the lane change.

- ▷ To initiate the lane change, press the turn indicator lever in the desired direction until it reaches the resistance point.
- ▷ Depending on vehicle equipment, the turn signal indicator can also be pushed beyond the resistance point.
- ▷ Depending on vehicle equipment, lane changes can already be triggered when the driver looks to make sure that current traffic situation will permit a lane change. In this case, the Lane Change Assistant must clearly detect the driving situation, and the Driver Attention Camera must clearly detect where the driver is looking. If necessary, the lane change function must be switched on when route guidance is active or the function must be set on the control display.



The Lane Change Assist initiates a lane change after a short time.

After the lane change, the system helps the driver keep the vehicle in lane.

Cancelling a lane change

The lane change can be cancelled by steering movement into the opposite direction or by operating the turn signal in the opposite direction.

Displays in the instrument cluster

Icon	Description
	Steering wheel symbol and arrow symbol for lane change green: The system carries out a lane change.
	Green steering wheel symbol and line for lane boundary on the affected side grey: The system has detected the lane change request. Lane change not currently possible.

Depending on vehicle equipment and national-market version, the information from the system in Assisted View is displayed in the central display area of the instrument cluster.

For further information:

Assisted View, see page [165](#).

System limits

The limits of the Assisted Driving Mode system apply.

The limits of the Driver Attention Camera system additionally apply to automatic lane changes.

For further information:

- ▶ Assisted Driving Mode, see page [243](#).
- ▶ Driver Attention Camera, see page [221](#).

Assisted Driving Mode Plus

Principle

Assisted Driving Mode Plus assists when driving the vehicle on motorways.

The system increases driving comfort in suitable driving situations.

Sensors in the steering wheel detect whether the steering wheel is being touched.

Depending on the equipment and national-market version, different versions of the function are available.

- ▶ Version for speeds up to approx. 60 km/h, approx. 40 mph, for example for traffic queues.
- ▶ Version for speeds up to approx. 135 km/h, approx. 85 mph.

General

For the version up to 135 km/h, approx. 85 mph, the following availability applies:

Assisted Driving Mode Plus is active at the time of vehicle delivery and is only available for a limited period. Information about the availa-

bility period of Assisted Driving Mode Plus will be available before and at the time of vehicle sale. Assisted Driving Mode Plus can be terminated prematurely due to technical or legal requirements. Further information on the availability of Assisted Driving Mode Plus can be requested from an authorised Service Partner.

Safety information

WARNING

The system does not relieve you of your personal responsibility to assess the traffic situation correctly. Due to system limits, it cannot respond independently and appropriately in all traffic situations. There is a risk of accident. Adapt your driving style to the traffic conditions. Observe the traffic situation, be ready to take over steering and braking at any time, and actively intervene if the situation warrants it.

WARNING

The system is only intended for use on roads with structural separation, such as motorways or similar. Due to system limits, the system can also remain activated on roads without structural separation and may react not as expected. There is a risk of accident. Deactivate the system if it is active on roads without structural separation.

The Assisted Driving Mode notices also apply.

For further information:

Assisted Driving Mode, see page [243](#).

Overview

Sensors

The system is controlled using the following sensors:

- ▷ The camera behind the windscreen.
- ▷ The front radar sensor.
- ▷ The radar sensors on the side, front.
- ▷ The radar sensors on the side, rear.
- ▷ The sensors in the steering wheel.
- ▷ The Driver Attention Camera.

The version up to 135 km/h, approx. 85 mph additionally uses the following sensors:

- ▷ The front camera.
- ▷ The exterior mirror cameras.
- ▷ The Reversing Assist Camera.

For further information:

Sensors in the vehicle, see page 42.

Operating requirements

The following functional requirements apply to Assisted Driving Mode Plus:

- ▷ Assisted Driving Mode Plus must be available in the country in which the vehicle is being driven.
- ▷ The functional requirements for Assisted Driving Mode are met.
Assisted Driving Mode is active and the LED displays on the steering wheel are switched on.
Assisted Driving Mode, see page 243.
- ▷ Driving on roads similar to motorways without pedestrians or cyclists and with physical barriers as separation from oncoming vehicles, for example, crash barriers.
- ▷ Lane boundaries are detected.
- ▷ The lane width is sufficiently wide.
- ▷ Sufficiently wide curve radius.
- ▷ The road and position of the vehicle must be clearly recognised by the navigation system.
- ▷ The function must be available on the road on which the vehicle is being driven.

- ▷ Aerials located in the roof must not be covered, for example, by roof loads or snow residue.
- ▷ The Driver Attention Camera in the instrument cluster detects that the driver is looking at the traffic situation.
- ▷ With a trailer tow hitch: operation with a trailer or operation with a rear carrier must be set on the control display in accordance with the use.

Driving with a trailer or rear carrier, see page 333.

For the version up to 60 km/h, approx. 40 mph, the following additional functional requirements apply:

- ▷ A vehicle ahead is detected.
- ▷ Speed below approx. 60 km/h/40 mph.

For the version up to 135 km/h, approx. 85 mph, the following additional functional requirements apply:

- ▷ Assisted Driving Mode Plus is enabled in the vehicle.
- ▷ The navigation data must be up to date.
- ▷ Speed up to approx. 135 km/h, approx. 85 mph.
- ▷ The systems in the vehicle, e.g. the Attention Assistant and the Driver Attention Camera recognise that the driver is rested.

Switching Assisted Driving Mode Plus on/off

1.  Apps menu
2. "Vehicle"
3. "Driving settings"
4. "Driver assistance"
5. "Driving"
6. "Assisted Driving"
7. "Assisted Driving Plus"

Assisted Driving Mode Plus is automatically offered when Assisted Driving is active and

all functional requirements for Assisted Driving Mode Plus are met.

Two green LEDs are illuminated on the steering wheel.



The indicator light in the instrument cluster is shown in green.

The system starts to help the driver to control the vehicle.

When the system is switched on, the following functions are active:

- ▷ Front collision warning.
- ▷ Side collision warning.
- ▷ For versions up to 135 km/h, approx. 85 mph: some cruise control systems, for example adjust speed to the course of the road.

Displays in the instrument cluster

Icon	Description
	Green indicator light: the system is active.
	Indicator light is grey: the system is interrupted and activates automatically as soon as all functional requirements are met.
	White indicator light: the system can be activated.

Depending on vehicle equipment and national-market version, the information from the system in Assisted View is displayed in the central display area of the instrument cluster.

For further information:

Assisted View, see page [165](#).

Displays on the steering wheel

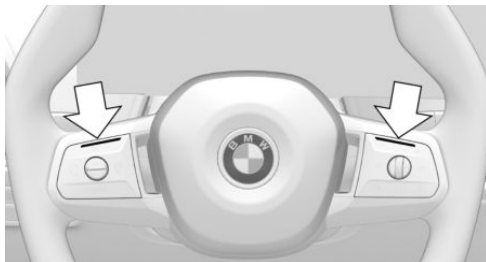

Depending on the situation, the two LEDs above the keypads light up.

- ▷ Green: the system is active.
- ▷ Yellow: the system has been interrupted.
Grab the steering wheel with your hands.
- ▷ Red: the system is deactivated.
Grab the steering wheel immediately with your hands.

For further information:

Assisted Driving Mode, see page [243](#).

Displays in the Head-up display

Depending on the equipment, the system information can also be displayed in the Head-up display.

Displays in the navigation system

For the version up to 135 km/h, approx. 85 mph, roads on which Assisted Driving Mode Plus supports vehicle guidance can be displayed in the navigation system.

1.  Navigation menu
2. "Suggestions"
3. Select the desired setting.

System limits

The system limits of the following systems apply:

- ▷ Assisted Driving Mode
- ▷ Driver Attention Camera

- ▶ For versions up to 135 km/h, approx. 85 mph: Attentiveness Assistant
- ▶ Sensors in the vehicle

For further information:

- ▶ Assisted Driving Mode, see page 243.
- ▶ Driver Attention Camera, see page 221.
- ▶ Attentiveness Assistant, see page 220.
- ▶ Sensors in the vehicle, see page 42.

Speed Limit Assist

Principle

Speed Limit Assist helps the driver to observe speed limits. A suggested speed can be adopted.

General

When the systems in the vehicle, for example Speed Limit Info, detect a change in the speed limit, it is possible to adopt this new speed value for the following systems:

- ▶ Manual Speed Limiter.
- ▶ Cruise Control.
- ▶ Distance control.
- ▶ Assisted Driving Mode.
- ▶ Assisted Driving Mode Plus.

The speed value is proposed as a new set speed for adopting. The relevant system must be activated for the speed value to be adopted.

Depending on the equipment, destination system and national-market version, the value may be applied automatically.

Safety information

WARNING

The system does not relieve you of your personal responsibility to assess the traffic situation correctly. Due to system limits, it cannot respond independently and appropriately in

all traffic situations. There is a risk of accident. Adapt your driving style to the traffic conditions. Observe the traffic situation, be ready to take over steering and braking at any time, and actively intervene if the situation warrants it.



WARNING

The set speed may be set incorrectly by mistake or called up accidentally. There is a risk of accident. Adjust the set speed to the traffic conditions. Observe the traffic situation and intervene actively if the situation warrants it

Overview

Buttons on the steering wheel

Button Function

	Accept the suggested speed manually.
	To set the speed; see Cruise Control.

Switching Speed Limit Assist on/off

1.  Apps menu
2. "Vehicle"
3. "Driving settings"
4. "Driver assistance"
5. "Driving"
6. "Speed Limit Assistant"
7. "Speed limits"
8. Select the desired setting:
 - ▶ "Adjust automatically": depending on the equipment, detected speed limits are applied automatically.
 - ▶ "Adjust manually": detected speed limits can be applied manually.

- ▶ "Show anticipation": current and upcoming speed limits are displayed in the instrument cluster without being applied.
- ▶ "Show current limit": current speed limits are displayed without being applied in the instrument cluster.
- ▶ "Off": depending on the national-market version, Speed Limit Info and Speed Limit Assist will be turned off.
If necessary, other predictive comfort functions will be turned off.

For further information:

Speed Limit Info, see page 227.

Displays in the instrument cluster

A message is displayed in the instrument cluster when the system and a Cruise Control System are activated.

Icon	Function
------	----------



Detected change in speed limit with immediate effect.

Remaining distance display shown alongside the icon indicates there might be a change in the speed limit up ahead.



Indicator light is illuminated green: the detected speed limit can be adopted with the SET button.

A green tick is displayed once it has been adopted.

Automatic adoption

"Adjust automatically": with the selected setting, a detected speed limit is automatically applied to Distance Control or the Manual Speed Limiter adopted.



After an automatic adoption, the button can be pressed to switch back to the last set value of the set speed.

Manual adoption

A detected speed limit can be applied manually to the active Cruise Control System.



When the SET icon is displayed, press the button.

Speed adjustment

Principle

It is possible to set whether the speed limit will be adopted exactly, or with a tolerance.

General

A speed adaptation for all speed limits and an additional speed adaptation for speed limits up to 60 km/h/40 mph can be set up.

The additional speed adaptation for speed limits up to 60 km/h/40 mph can be activated or deactivated.

Setting the speed adjustment

1. Apps menu
2. "Vehicle"
3. "Driving settings"
4. "Driver assistance"
5. "Driving"
6. "Speed Limit Assistant"
7. Select the desired setting:
 - ▶ "Adjust speed limits": set the tolerance for speed adjustments, which applies to all speed limits.
 - ▶ "2nd adjustm. up to": activate or deactivate additional speed adjustment.
 - ▶ "Adjust speed limits": with activated additional speed adjustment, set the tolerance for speed limits up to 60 km/h/40 mph.

System limits

Speed Limit Assist is based on the Speed Limit Info system.

Take into account the Speed Limit Info system limits.

Depending on the national-market version, upcoming speed limits may not be available for application or they may only be available to a certain extent, for instance information from the map data of the navigation system.

Cruise Control without distance control: depending on the system, it may not be possible to adopt speed limits automatically.

Upcoming speed limits can only be applied to the Cruise Control with distance control.

With a trailer tow hitch: speed values to be adopted are limited to the value set on the control display for trailer operation.

For further information:

- ▶ System limits of Speed Limit Info, see page 230.
- ▶ System limits of the sensors, see page 42.
- ▶ Driving with a trailer or rear carrier, see page 333.

Adapting the speed to the route

Principle

The system can be configured so that with active distance control, the vehicle adapts the speed automatically to the route.

For example, the speed is reduced in the following situations if necessary:

- ▶ Before turning off.
- ▶ Before a roundabout.
- ▶ Before a bend.
- ▶ In front of an exit junction on motorways or motorway-like roads.

Safety information

WARNING

The system does not relieve you of your personal responsibility to assess the traffic situation correctly. Due to system limits, it cannot respond independently and appropriately in all traffic situations. There is a risk of accident. Adapt your driving style to the traffic conditions. Observe the traffic situation, be ready to take over steering and braking at any time, and actively intervene if the situation warrants it.

In addition, the notices for Cruise Control, Distance Control, Assisted Driving Mode and Speed Limit Assist apply.

For further information:

- ▶ Cruise Control, see page 235.
- ▶ Distance control, see page 237.
- ▶ Assisted Driving Mode, see page 243.
- ▶ Speed Limit Assist, see page 253.

Operating requirements

- ▶ Cruise Control and distance control are activated.
- ▶ Driving on a motorway or a similar road.
- ▶ With navigation system: route guidance is activated.

The use of navigation software via Apple CarPlay or Android Auto may lead to functional limitations, for example deviations from instructions given by the navigation system.

- ▶ The function must be available in the country in which the vehicle is being driven.
- ▶ With a trailer tow hitch: operation with a trailer or operation with a rear carrier must be set on the control display in accordance with the use.

Driving with a trailer or rear carrier, see page 333.

Adapt speed automatically to route

1.  Apps menu
2. "Vehicle"
3. "Driving settings"
4. "Driver assistance"
5. "Driving"
6. "Route and junction assistant"
7. "Automatically adjust speed to route"

Adjusting the cornering speed

Depending on the national-market version, the cornering speed can be set.

1.  Apps menu
2. "Vehicle"
3. "Driving settings"
4. "Driver assistance"
5. "Driving"
6. "Route and junction assistant"
7. "Cornering speed"
8. Select the desired setting.

Displays in the instrument cluster

Depending on vehicle equipment and national-market version, the information from the system in Assisted View is displayed in the central display area of the instrument cluster.

For further information:

Assisted View, see page [165](#).

System limits

Depending on the national-market version or country in which the vehicle is currently being driven, the function may not be available.

The system does not respond at all or responds only to a limited extent on the route ahead in the following situations for example:

- ▷ If the position of the vehicle cannot be clearly determined by the navigation system.

- ▷ On wintry carriageways.

Additionally, the limits of the Cruise Control, distance control, Assisted Driving Mode and Speed Limit Assist systems apply.

For further information:

- ▷ Cruise Control, see page [235](#).
- ▷ Distance control, see page [237](#).
- ▷ Assisted Driving Mode, see page [243](#).
- ▷ Speed Limit Assist, see page [253](#).

Lane change with active route guidance

Principle

Lane change with active route guidance assists the driver when a lane change is needed in order to reach a destination. A warning is displayed in the instrument cluster. In addition, a slight jerk can be felt on the steering wheel.

General

The system uses the Assisted Driving Mode sensors.

Safety information

WARNING

The system does not relieve you of your personal responsibility to assess the traffic situation correctly. Due to system limits, it cannot respond independently and appropriately in all traffic situations. There is a risk of accident. Adapt your driving style to the traffic conditions. Observe the traffic situation, be ready to take over steering and braking at any time, and actively intervene if the situation warrants it.

The Cruise Control, Distance Control and Assisted Driving Mode notices also apply.

For further information:

- ▶ Cruise Control, see page 235.
- ▶ Distance control, see page 237.
- ▶ Assisted Driving Mode, see page 243.

Operating requirements

- ▶ Cruise Control and Distance Control are activated.
- ▶ Driving on a motorway or a similar road.
- ▶ A situation-dependent minimum speed has been reached.
- ▶ The system detects a sufficiently large gap in traffic in the adjacent lane.

- ▶ A lane boundary that can be driven over is detected on the side of the desired lane change.

- ▶ Route guidance is active in the navigation system.

The function is not available when using navigation software via Apple CarPlay or Android Auto.

- ▶ The function must be available in the country in which the vehicle is being driven.
- ▶ With a trailer tow hitch: operation with a trailer or operation with a rear carrier must be set on the control display in accordance with the use.

Driving with a trailer or rear carrier, see page 333.

Switching lane change on/off with active route guidance

1.  Apps menu
2. "Vehicle"
3. "Driving settings"
4. "Driver assistance"
5. "Driving"

6. "Route and junction assistant"
7. "Actively follow the route"

Switching the steering wheel jerk on/off

The assistance provided by the jerk on the steering wheel can be switched on/off.

1.  Apps menu
2. "Vehicle"
3. "Driving settings"
4. "Driver assistance"
5. "Driving"
6. "Route and junction assistant"
7. "Steering wheel impulse"

Changing driving lane

If lane changes are necessary to reach a navigation destination, a corresponding message is displayed in the instrument cluster. In addition, a slight jerk can be felt on the steering wheel.

To change lanes, follow the instructions in the instrument cluster.



1.  The system detects a suitable gap in the flow of traffic in the adjacent lane. A green check mark is displayed in the instrument cluster on the lane change icon. The system prepares for the lane change.
2. When a suitable gap has been found, the speed is adapted so the vehicle stays level with the gap.
3. A lane change suggestion is displayed with a Check Control message.
4. If the traffic situation permits a lane change, the driver can steer the vehicle into the adjacent lane.

If the vehicle is equipped with the Lane Change Assistant: once the Check Control message has been displayed, the Lane

Change Assistant can be started by operating the turn indicator, for example.

Display in the instrument cluster

Icon	Function
------	----------



Indicates a necessary lane change. The icon varies depending on the traffic situation.



A green check mark on the icon indicates the active function.

A red cross on the icon indicates that the system cannot support lane change.

Depending on the equipment and national-market version, the traffic situation is displayed in the Assisted View in the central display area of the instrument cluster.

For further information:

Assisted View, see page 165.

System limits

The limits of the Cruise Control, Distance Control and Assisted Driving Mode systems apply.

For further information:

- ▶ Cruise Control, see page 235.
- ▶ Distance control, see page 237.
- ▶ Assisted Driving Mode, see page 243.

Traffic light detection

Principle

Traffic light detection assist when stopping at red traffic lights and draws attention to when it is possible to continue driving.

General

The camera near the interior mirror is used to detect red traffic lights.

If necessary, the system also uses the Driver Attention Camera and the information that has been saved in the navigation system.

Detected red traffic lights are displayed in the instrument cluster and, depending on the setting, can be taken into account either manually or automatically during the journey.

Safety information

WARNING

The system does not relieve you of your personal responsibility to assess the traffic situation correctly. Due to system limits, it cannot respond independently and appropriately in all traffic situations. There is a risk of accident. Adapt your driving style to the traffic conditions. Observe the traffic situation, be ready to take over steering and braking at any time, and actively intervene if the situation warrants it.

Overview

Button on the steering wheel

Button	Function
--------	----------



Accept detected traffic lights manually.

Sensors

The system is controlled by the camera behind the windscreen.

Operating requirements

- ▶ Cruise Control and distance control are activated.
- ▶ Speed up to approx. 80 km/h, 50 mph.
- ▶ The function must be available in the country in which the vehicle is being driven.

Adjusting the traffic light detection



1.  Apps menu
2. "Vehicle"
3. "Driving settings"
4. "Driver assistance"
5. "Driving"
6. "Route and junction assistant"
7. "Stop at traffic lights"
8. Select the desired setting.

Activating/deactivating drive off reminder

With activated drive off reminder, there will be visual and acoustic information as soon as driving can continue at a green traffic light.

1.  Apps menu
2. "Vehicle"
3. "Driving settings"
4. "Driver assistance"
5. "Driving"
6. "Route and junction assistant"
7. "Drive off reminder"

Displays in the instrument cluster

Icon	Meaning
	Red traffic light detected. As soon as a green tick is displayed after adoption, the vehicle brakes to a standstill.
	Green traffic light detected.

Icon Meaning



Grey traffic light: the system is interrupted.

If the grey traffic light is displayed with a red cross, it cannot be offered for acceptance.



The detected traffic light can be applied with the SET button.

A green tick is displayed once it has been adopted.

System limits

The traffic light detection system may have restricted functionality in situations such as the following:

- ▶ When traffic lights are hidden, for example, by other vehicles.
- ▶ At a road junction with multiple lanes where there are several sets of traffic lights.

For further information:

System limits of the sensors, see page [42](#).

Parking

Vehicle equipment

This chapter describes equipment, systems and functions which are offered or may be offered in future on a model-specific basis, even if they are not included in the vehicle in question.

For further information:

Vehicle equipment, see page 8.

Park assistance systems

General

The parking assistance systems include different individual systems. The individual systems provide support with assistance functions, sensors and different camera views when parking, manoeuvring or driving in reverse.

For further information:

- ▷ Reversing Assist Camera, see page 265.
- ▷ Semi-automatic camera perspective, see page 266.
- ▷ Automatic camera perspective, see page 266.
- ▷ Flank view, see page 267.
- ▷ 3D view, see page 267.
- ▷ Trailer tow hitch view, see page 268.
- ▷ Conveyor car wash view, see page 268.
- ▷ Panorama View, see page 269.
- ▷ Automatic activation of the panorama view, see page 269.
- ▷ Door opening angle, see page 270.
- ▷ Remote 3D View, see page 271.
- ▷ Park Distance Control, see page 272.
- ▷ Active Park Distance Control, see page 275.

- ▷ Drive off monitoring, see page 276.
- ▷ Park Assist, see page 277.
- ▷ Manoeuvre Assistant, see page 283.
- ▷ Remote Control Parking, see page 286.
- ▷ Reversing Assistant, see page 287.
- ▷ Trailer Assistant, see page 335.

Safety information

WARNING

The system does not relieve you of your personal responsibility to assess the traffic situation correctly. Due to system limits, it cannot respond independently and appropriately in all traffic situations. There is a risk of accident. Adapt your driving style to the traffic conditions. Observe the traffic situation, be ready to take over steering and braking at any time, and actively intervene if the situation warrants it.

Overview

Button in the vehicle

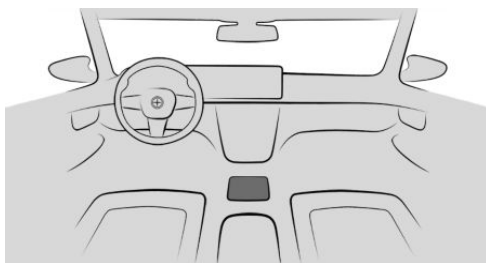

Park Assist button

Sensors

The parking assistance systems are controlled by the following sensors:

- ▶ Ultrasonic sensors in the front/rear bumpers.
- ▶ Side ultrasonic sensors.
- ▶ Side radar sensors, front.
- ▶ Side radar sensors, rear.
- ▶ Front camera.
- ▶ Exterior mirror cameras.
- ▶ Reversing Assist Camera.

For further information:

Sensors in the vehicle, see page 42.

Operating concept

The camera-based individual systems are operated with the toolbars on the control display. Choose a camera view by selecting the appropriate icon.

In the Park menu, parking assistance functions can be set individually.

Some parking assistance systems can be executed with voice control, for example parking in and out of a parking space with the Automatic Parking Assistant.

For further information:

BMW Intelligent Personal Assistant, see page 60.

Go to Park menu

1.  Apps menu
2. "Vehicle"
3. "Driving settings"
4. "Driver assistance"
5. "Parking"
6. Select the desired settings.

Display

Principle

The parking assistance systems support parking and manoeuvring or reversing by displaying Park Distance Control and via various camera views.

General

Depending on vehicle equipment, one or more cameras record the area from different selectable perspectives.

Depending on the view, the vehicle surroundings or a partial area are displayed.

Depending on the national-market version, either the automatic or the semi-automatic camera perspective is displayed.

Turning the display on/off

General

When driving forwards, the parking assistance systems display turns off automatically when a certain distance or speed is exceeded.

With the reverse gear

The display is automatically turned on if selector lever position R is engaged while drive-ready state is turned on.

Via Parking Assistant button



Press the key.

Via iDrive

1.  Apps menu
2. "Vehicle"
3. "Parking"

Display in the instrument cluster

The instrument cluster shows displays of some parking assistance systems, for example Park Distance Control or Park Assist.

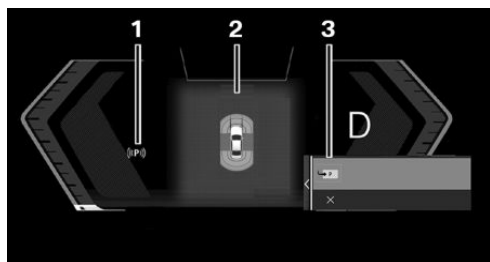

- 1 Status of parking assistance systems
- 2 Assisted View
- 3 Selection menu

Display on the control display

General

The display on the control display will vary depending on the equipment and the activated parking assistance system.

Assistance view

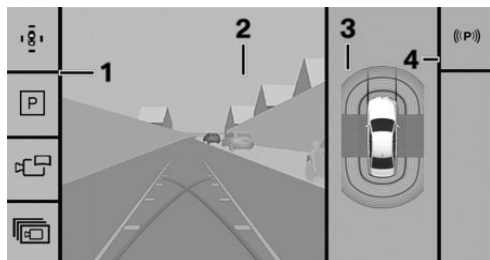

- 1 Toolbar, left
- 2 Camera image
- 3 Top view of vehicle
- 4 Toolbar, right

Parking view

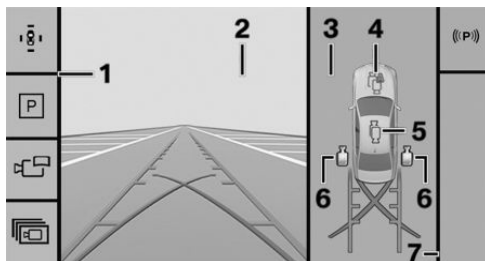



- 1 Toolbar, left
- 2 Camera image
- 3 Selection window
- 4 Automatic camera perspective
- 5 Semi-automatic camera perspective
- 6 Flank view
- 7 Toolbar, right

Toolbar, left

Depending on the equipment, different views and settings can be selected via the left toolbar.

- ▶ "Parking view"
Depending on the equipment, camera images or the view of the Park Distance Control are displayed.
- ▶ "Assist view"
A stylised view of the vehicle top view is displayed.
- ▶ "Panorama view"
The view for crossing traffic is displayed.
- ▶ "More"
 - ▶ "3D view"
A three-dimensional view is shown.
 - ▶ "Trailer coupling view"
The zoom for the trailer tow hitch can be turned on.
 - ▶ "Car wash view"

The display of your own lane can be turned on for easier driving into the car wash.

- ▶  "Camera cleaning"
If necessary, cleaning of the front camera and the Reversing Assist Camera can be switched on.
- ▶  "Settings"
Settings can be entered in the Park menu.

Toolbar, right

The parking assistance functions are displayed in the right toolbar:





- ▶ Status of the parking assistance systems.
- ▶ Available parking methods of the Park Assist.
- ▶ Functions of the Reversing Assistant.
- ▶ Functions of the Manoeuvre Assistant.
- ▶ Trailer Assistant functions.
- ▶ Additional information in case of malfunctions.

Status of the parking assistance systems

The status of the following parking assistance systems is displayed:

- ▶ Park Assist.
- ▶ Manoeuvre Assistant.
- ▶ Reversing Assistant.
- ▶ Trailer Assistant.

The icons are shown on the control display in the right toolbar and in the instrument cluster in the status area. In addition to the icon, a message is displayed on the control display.

Icon	Meaning
	No search for parking assistance system services. No other parking assistance systems available. Parking assistance systems have failed.
	Search for parking assistance system services is active.
	White: an available manoeuvre is selected but will not be performed. Functional requirements have not been met or the transfer of functions has been completed. Green: parking assistance system is active. Depending on the activated system, the functions are adopted.
	Manoeuvre Assistant records the manoeuvre to be stored.

Additional displays

General

Additional views, for example parking assistance lines, can be shown on the camera image on the parking assistance system display to facilitate parking and manoeuvring.

A number of additional displays can be active simultaneously.

Switching additional displays on/off

1.  Apps menu
2. "Vehicle"
3. "Driving settings"
4. "Driver assistance"
5. "Parking"
6. Select the desired setting.



Parking assistance lines

Driving lane lines

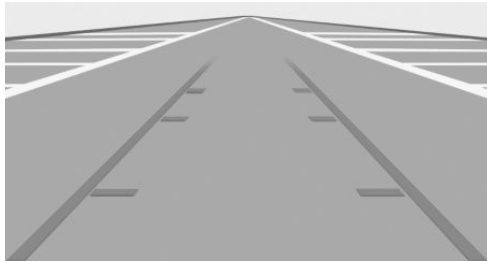

The driving lane lines help in estimating the space requirement when parking and manoeuvring on a level road surface.

Depending on the gear engaged, the driving lane lines are displayed in front of or behind the vehicle.

The driving lane lines are continuously adapted to the steering wheel movements depending on the steering wheel angle.

Turning circle lines

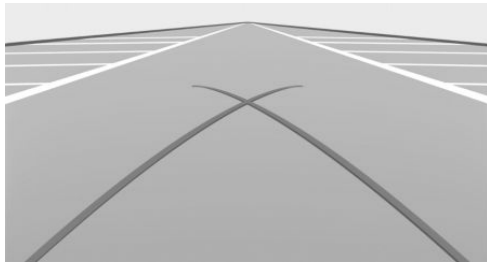

Turning circle lines can only be superimposed on the camera image together with lanes.

The lines show the course of the smallest possible turning circle on a level road.

Once the steering wheel has been turned beyond a certain angle, only one turning circle line is displayed.

Using parking assistance lines

1. Position the vehicle so that the red turning circle line is within the boundaries of the parking space.
2. Turn the steering wheel so that the green driving lane line covers the corresponding turning circle line.

Obstacle marking

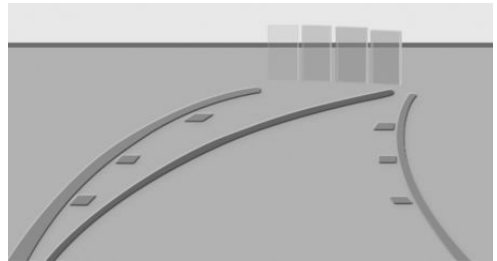

Obstacles are detected by the sensors.

Obstacles detected by Park Distance Control are marked on the camera image.

Coloured gradations of the obstacle markings in green, yellow and red indicate the distances.

Functional limitations

The system can only be used to a restricted extent in the following situations:

- ▷ With a door open.
- ▷ With open luggage compartment.
- ▷ With the exterior mirrors folded in.

Areas with grey hatching with an icon in the camera image identify areas that are currently not shown, for example an open door.

System limits

Safety information

WARNING

Due to system limitations, the system may not respond at all, or may respond too late, incorrectly or for no reason. There is a risk of accident or material damage. Observe the information on the system limits and intervene actively if necessary.

System limits of the sensors

For further information:

Sensors in the vehicle, see page 42.

Field of view

Due to the angle of view, the area under the vehicle cannot be seen by the cameras.

Detection of objects

The system cannot detect very low obstacles and higher, protruding objects such as ledges.

The objects shown in the control display may be closer than they appear. Do not estimate the distance to the objects on the control display.

Projecting loads, rear carriers, or trailers can restrict the detection range of the camera.

Malfunction

Failure of one camera is shown on the control display.

The detection range of the failed camera is displayed hatched on the control display.

Reversing Assist Camera

Principle

The Reversing Assist Camera assists in reverse parking and manoeuvring. It does this by showing an image of the area behind the vehicle on the control display.

Additional displays can be shown in the display, for example parking assistance lines and obstacle marking.

General

Follow the information in the Chapter "Parking assistance systems".

Operating requirements

- ▷ The luggage compartment is fully closed.
- ▷ The camera area is clean and unobstructed.

Turning the Reversing Assist Camera on/off

Switching the camera view on automatically

The Reversing Assist Camera is automatically turned on if selector lever position R is engaged while drive-ready state is turned on.

Switching the camera view off automatically

When driving forwards, the Reversing Assist Camera turns off automatically when a certain distance or speed is exceeded, if necessary.

Switching the camera view on/off manually



1. Press the button.
2. Engage selector lever position R.

 Depending on the equipment: the icon in the selection window is automatically selected.

To exit the camera view of the Reversing Assist Camera, select another camera view in the selection window or press the button again.

Deactivated Reversing Assist Camera

When the Reversing Assist Camera is deactivated, for example when the luggage compartment is open, the camera image is displayed hatched in grey.

Semi-automatic camera perspective

Principle

Depending on the parking direction and engaged selector lever position, a fixed camera perspective is displayed with the areas in front of or behind the vehicle.

General

Follow the information in the Chapter "Parking assistance systems".

Switching semi-automatic camera perspective on/off



1. Press the button.
2. Select the  icon in the selection window.
To exit the fixed camera view, select another camera view in the selection window.

Automatic camera perspective

Principle

The automatic camera perspective displays a steering angle-dependent view looking towards the vehicle's direction of travel.

This perspective adapts to the current driving situation.

General

As soon as obstacles are detected, the view switches to a fixed display of the area in front of or behind the bumper or, if necessary, to the side Park Distance Control (PDC).

When the reverse gear is engaged, the automatic camera perspective is, if necessary, exited and the system uses a semi-automatic camera perspective to the rear. If required, select the automatic camera perspective with reverse gear engaged. The automatic camera perspective is retained for the current parking manoeuvre.

Follow the information in the Chapter "Parking assistance systems".

Switching the automatic camera perspective on/off



Switching the camera view on/off automatically

When the display of the parking assistance systems is switched on, the automatic camera perspective is automatically selected.

 The icon in the selection window is automatically selected.

To exit the steering-dependent camera view, select a different camera view in the selection window.

Switching the camera view on/off manually

-  Press the button.
-  The icon in the selection window is automatically selected.
To exit the steering-dependent camera view, select another camera view in the selection window or press the button again.

Lateral Parking Aid

Principle

The Lateral Parking Aid is automatically displayed when the automatic camera perspective is switched on. This feature shows obstacles located near the vehicle.

General

Follow the information in the Chapter "Parking assistance systems".

Display

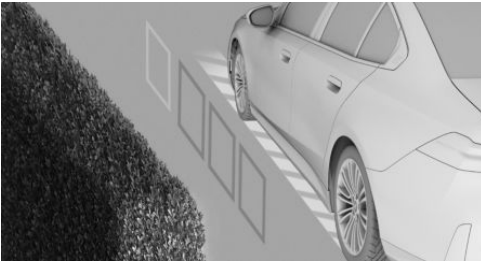

Obstacle markings are displayed at the sides of the vehicle to protect the vehicle's flanks.

- ▶ No markings: no obstacles detected.
- ▶ Coloured markings: warning that obstacles have been detected.

System limits

The system only shows stationary obstacles that were previously detected by the sensors when driving past.

The system does not detect whether an obstacle subsequently moves. Consequently, the markings will no longer be shown on the display after the vehicle has been stationary for a while. The area next to the vehicle needs to be scanned again.

Flank view

Principle

The flank view displays the area at the side of the vehicle to assist with positioning the vehicle at the kerb or alongside any other obstacles.



Flank view looks from the rear to the front. If there is a hazard, it automatically focuses on possible obstacles.

General

Follow the information in the Chapter "Parking assistance systems".

Switching the flank view on/off

Flank view can be selected for the right or left side of vehicle in the selection window.

-  Press the button.
- Select the  icon for the desired vehicle side in the selection window.
To exit the flank view, select another camera view in the selection window.

3D view

Principle

In the 3D view, a circle around the top view of the vehicle is displayed in the selection window.

Specified perspectives can be selected on the circle.



General

The current perspective is identified by a camera icon.

Follow the information in the Chapter "Parking assistance systems".

Turning the 3D view on/off



1. Press the button.

2. "More"

3. "3D view"

To exit the 3D view, select another camera view in the left toolbar.

Trailer tow hitch view

Principle

To assist with connecting up a trailer, it is possible to zoom in on the area around the trailer tow hitch.

General

When zooming in, remember that the view might no longer show certain obstacles.

Follow the information in the Chapter "Parking assistance systems".

Switching the trailer tow hitch view on/off



1. Press the button.

2. "More"

3. "Trailer coupling view"

To exit the trailer tow hitch view, select another camera view in the left toolbar.

Display

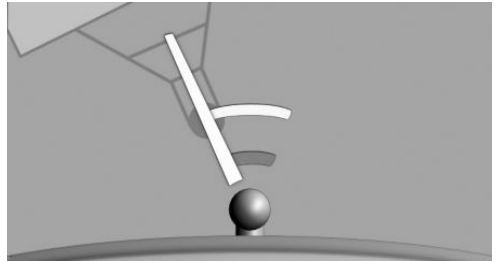

Two static circular segments help to estimate the distance of the trailer to the trailer tow hitch.

A docking line dependent on the steering wheel angle assists with lining up the trailer tow hitch with the trailer.

Conveyor car wash view

Principle

The conveyor car wash view assists when entering a car wash.

General

Follow the information in the Chapter "Parking assistance systems".

Switching the conveyor car wash view on/off



1. Press the button.

2. "More"

3. "Car wash view"

To exit the car wash view, select another camera view in the left toolbar.

Display

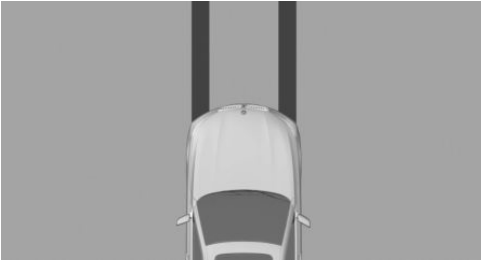

Your own lane is displayed for easier driving into a car wash.

The display can be used to position the vehicle correctly in the guide rails of the car wash.

The vehicle must be able to roll freely while in the car wash.

For further information:

For rolling or pushing the vehicle, see page [137](#).

Panorama View

Principle

The panoramic view gives you an earlier view of crossing traffic at blind driveway exits and road junctions.

General

Road users hidden by obstacles at the side may not be seen from the driver's seat until very late. The front camera and the Reversing Assist Camera capture the area around the side of the vehicle to improve the view.

The camera image is subject to varying levels of distortion in some areas and is thus not suitable for estimating distances.

Depending on the equipment, the function can be used when driving forwards or reversing.

Follow the information in the Chapter "Parking assistance systems".

Sensors

The system is controlled by the following cameras:

- ▷ Reversing Assist Camera.
- ▷ Depending on the equipment: front camera.

Switching the panorama view on/off

1.  Press the button.
2. "Panorama view"
To exit the panorama view, select another camera view in the left toolbar.

Display

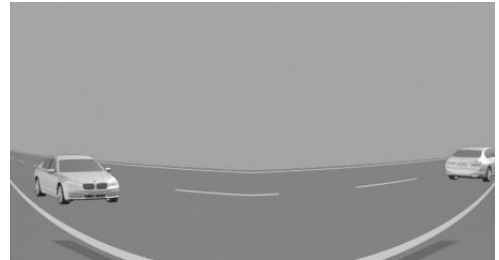

Yellow lines on the screen mask identify the bumpers of your own vehicle.

Depending on the engaged selector lever position, the camera view of the Reversing Assist Camera or front camera will be displayed.

Automatic activation of the panorama view

Principle

Positions at which the panoramic view should switch on automatically can be saved as activation points.

General

Up to ten activation points can be saved.

The activation points can be used when driving forwards and, depending on the national-market version, when reversing.

Follow the information in the Panorama view chapter.

Operating requirements

- ▶ A GPS signal must be received.
- ▶ Depending on the national-market version: a BMW ID or a driver profile must be activated.
- ▶ The direction of travel, selector lever position and vehicle angle must correspond to a saved activation point.

Saving activation points

1. Drive the vehicle to the position where the system should switch on and stop.



2.  Press the button.

3. "Panorama view"

4. "Activation point"

The current position is shown.

5. "Save activation point"

Activation points are saved with the following information, for example:

- ▶ Location.
- ▶ Location and street.
- ▶ GPS coordinates.

The automatically created location and street information can be renamed.

Using activation points

Use of activation points can be switched on and off.

1.  Apps menu
2. "Vehicle"
3. "Driving settings"
4. "Driver assistance"

5. "Parking"
6. "GPS-based"

Editing activation points

Any or all of the activation points can be renamed or deleted.



1.  Press the button.

2. "Panorama view"

3. "Manage points"

A list of all saved activation points is shown.

4. Select the desired setting.

Door opening angle

Principle

Depending on the equipment, the door opening angle indicator is displayed automatically when stationary.

The display helps to estimate how far the doors can be opened in a parking situation.

If obstacle marking is activated, the parking view indicates fixed obstacles that obstruct the opening angles of the doors.

General

Follow the information in the Chapter "Parking assistance systems".

Display

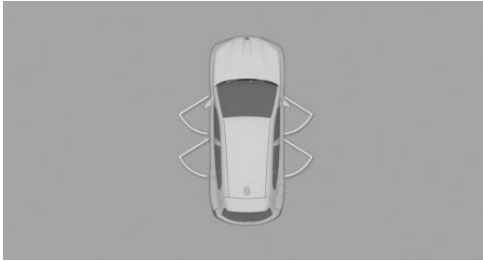

The maximum door opening angles are displayed when the selector lever is in position P.

System limits

The system does not issue warnings about approaching road users.

For technical reasons, the display of the vehicle surroundings is distorted.

Even if the door opening angle indicator on the control display does not superimpose any other objects, it is necessary to park carefully next to other objects.

The perspective means that protruding objects located higher up may be closer than they appear on the control display.

Remote 3D View

Principle

The My BMW App and the camera views in the parking view, for example automatic camera perspective, enable the display of the vehicle surroundings on a mobile end device.

The function shows a view of the current situation.

General

For reasons related to data protection, the function can only be run three times in two hours.

Follow the information in the Chapter "Parking assistance systems".

Sensors

The system is controlled by the following cameras:

- ▷ Front camera.
- ▷ Exterior mirror cameras.
- ▷ Reversing Assist Camera.

Operating requirements

- ▷ Data transfer must be activated.
Data protection, see page 74.
- ▷ The My BMW App must be installed on the mobile device.
- ▷ ConnectedDrive countries: a BMW ID with an existing ConnectedDrive account must be activated.
BMW ID/driver profiles, see page 75.

Activating/deactivating Remote 3D View

The function can be activated or deactivated individually or together with other functions.

1.  Apps menu
2. "Vehicle"
3. "System settings"
4. "Data privacy"
5. Select the desired setting.

After the activation, Remote 3D View can be accessed in the My BMW App.

Functional limitations

The system may have restricted functionality or may not be available at all in situations such as the following:

- ▶ With a door or the luggage compartment open. Areas that the system is not able to record are shown dark on the display.
- ▶ If the exterior mirrors have been folded in manually.
- ▶ When other camera functions are being run in the vehicle.
- ▶ The vehicle moves faster than at walking speed.
- ▶ In case of missing or weak Internet connection.

Park Distance Control

Principle

Park Distance Control assists with parking. Obstacles in front of or behind the vehicle are signalled by acoustic and visual warnings.

Obstacles that are detected by the side ultrasonic sensors can also be reported.

General

The range of the system is approximately 2 m, 6 ft, depending on the obstacle and environmental factors.

An acoustic warning is given when the vehicle is approx. 70 cm, 27 in away from an object and a collision is imminent.

For objects behind the vehicle, the acoustic warning is given sooner, at a distance of approx. 1.50 m, 5 ft.

Follow the information in the Chapter "Parking assistance systems".

Safety information

WARNING

The system does not relieve you of your personal responsibility to assess the traffic situation correctly. Due to system limits, it cannot respond independently and appropriately in

all traffic situations. There is a risk of accident. Adapt your driving style to the traffic conditions. Observe the traffic situation, be ready to take over steering and braking at any time, and actively intervene if the situation warrants it.

WARNING

Approaching at high speed when Park Distance Control is activated may result in late warnings due to the physical conditions. There is a danger of injury or material damage. Avoid approaching an object at speed. Avoid driving off at speed while Park Distance Control is not yet activated.

Sensors

The system is controlled using the following sensors:

- ▶ Ultrasonic sensors in the front/rear bumpers.
- ▶ Side ultrasonic sensors.

Turning Park Distance Control on/off

Switching on the system automatically

The system switches on automatically in the following situations:

- ▶ With drive-ready state switched on, when selector lever position R is engaged.
- ▶ When approaching detected obstacles, if the speed is less than approximately 4 km/h, approx. 2.5 mph The distance from the obstacle at which the system activates depends on the individual situation.

The automatic activation in the event of detected obstacles can be activated or deactivated.

1.  Apps menu
2. "Vehicle"

3. "Driving settings"
4. "Driver assistance"
5. "Parking"
6. "Automatic PDC activation"

Turning off the system automatically

When driving forwards, the system turns off automatically when a certain distance or speed is exceeded, if necessary.

Switching the system on/off manually



Press the key.

- ▶ On: the LED is illuminated.
- ▶ Off: the LED is extinguished.

If the system is manually switched on when reverse gear is engaged, the image of the Reversing Assist Camera is displayed.

Depending on the national-market version, the system cannot be turned off manually when the reverse gear is engaged.

Acoustic warning

General

An intermittent tone indicates that the vehicle is approaching an object. For example, if an object is detected to the rear left of the vehicle, the sound is emitted from the rear left loudspeaker.

The shorter the distance to an object, the shorter the intervals of the intermittent tones.

A continuous tone sounds if the distance to a detected object is less than approximately 20 cm, 8 in.

An alternating continuous tone sounds from the front and rear loudspeakers if there are objects in front and behind the vehicle at the same time and at a distance of less than approximately 20 cm, 8 in.

The intermittent tones and the continuous tone are turned off when selector lever position P is engaged.

Depending on the national-market version, the interval tones are switched off after a short time with the vehicle at a standstill.

If an object approaches when the vehicle is stationary, the acoustic signal is reactivated.

Adjusting the volume

The volume of the acoustic warning can be adjusted.

1.  Apps menu
2. "Vehicle"
3. "Driving settings"
4. "Driver assistance"
5. "Parking"
6. "PDC signal volume"
7. Set the desired value.

Switching off the acoustic warning

Depending on the national-market version, the acoustic warning can be switched off after the start of the parking manoeuvre.

Press the  icon in the status field at the top of the control display.

No audible warning is emitted during active parking.

When the Park Distance Control is switched on again, the acoustic warning is automatically switched on again.

Visual warning

General

When you are approaching an object, its proximity is displayed on the control display and in the instrument cluster as soon as the system is activated.

Objects that are farther away are already displayed before a signal sounds.



Depending on the view, driving lane lines, turning circle lines and obstacle markings are shown for a better estimation of the space required.

Depending on the equipment, the detection range of the sensors is represented by hatched ring-shaped areas. Markings in green, yellow and red indicate when obstacles are detected in the detection range.

If equipped with the Crossing-traffic Warning: the display also warns of vehicles approaching from the sides at the front and rear.

Obstacle markings are displayed at the sides of the vehicle to protect the vehicle's flanks.

Display

Depending on the equipment, warnings may be displayed in front of, next to and behind the vehicle.

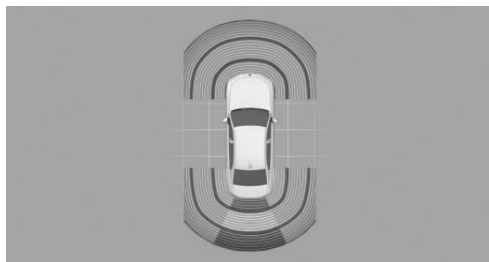

Display behind the vehicle.

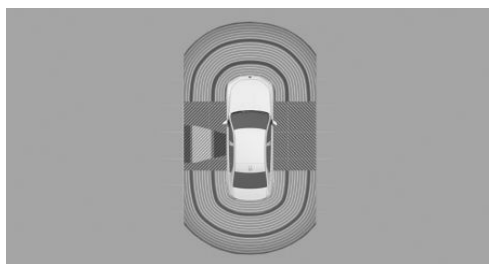

Display next to the vehicle.

- ▷ Hatched area: detection range of the sensors.
- ▷ Grey hatched area: no obstacles were detected in the detection range.
- ▷ Coloured markings in the hatched area: obstacles were detected in the detection range.
- ▷ Hatched area interrupted: the area next to the vehicle has not yet been recorded.

System limits

General

The function to protect the vehicle sides only shows stationary obstacles that were previously detected by the sensors when driving past.

The system does not detect whether an obstacle subsequently moves. The grey hatched areas on the sides are hidden after a certain period of time when the vehicle is at a standstill. The area on the side of the vehicle must be newly captured.

Also observe the limits of the system in the chapter "Parking assistance systems".

Trailer operation

With a trailer or when the trailer socket is occupied, the rear functions of Park Distance Control are switched off.

Depending on the equipment, the detection range of the sensors is shown dark on the control display.

Obstacles next to the vehicle are not displayed. Depending on the national-market version, the rear functions of Park Distance Control remain switched on when the trailer operation is activated.



An icon is displayed on the control display.

For further information:

Towing a trailer, see page [333](#).

False alarms

If the system is approaching its limits, false alarms may occur.

To reduce false alarms, for example in conveyor car washes, switch off automatic activation of Park Distance Control when obstacles are detected if necessary.

Malfunction



An icon is displayed on the control display.

Depending on the equipment, the detection range of the sensors is not displayed on the control display.

A Check Control message is shown.

Park Distance Control failure. Have the system checked by an authorised Service Partner or another qualified Service Partner or a specialist workshop.

Active Park Distance Control

Principle

The Park Distance Control brake function initiates emergency braking if there is an imminent risk of collision.

General

Due to the system limits, a collision cannot be prevented under all circumstances.

The function is available at speeds below walking speed when reversing or rolling back.

Pressing the accelerator pedal suppresses the brake intervention. Emergency braking is not performed.

After emergency braking to a stop, it is possible to continue a slow approach to the obstacle. To approach, lightly depress the accelerator pedal and release it again.

If the accelerator pedal is depressed for longer, the vehicle pulls away. Manual braking is possible at any time.

Follow the information in the Chapter "Parking assistance systems".

Safety information

WARNING

The system does not relieve you of your personal responsibility to assess the traffic situation correctly. Due to system limits, it cannot respond independently and appropriately in all traffic situations. There is a risk of accident. Adapt your driving style to the traffic conditions. Observe the traffic situation, be ready to take over steering and braking at any time, and actively intervene if the situation warrants it.

WARNING

When the trailer tow hitch is in use, the assistance system cannot react correctly if its sensors are obstructed. There is a risk of accident or material damage. Do not use the assistance system in trailer operation or when using the trailer tow hitch, for example with a rear bicycle carrier.

Sensors

The system is controlled using the following sensors:

- ▶ Ultrasonic sensors in the rear bumpers.
- ▶ Side ultrasonic sensors.

Temporarily deactivating Active Park Distance Control

After emergency braking, the function can be temporarily deactivated on the control display.

1. "Obstacle detected. Emergency braking."
2. "Deactivate temporarily"

If the journey is continued in these environmental conditions, no further emergency braking is performed.

The function is automatically reactivated when the Park Distance Control is switched on again.

Settings

It is possible to set which areas of the vehicle are protected by the system.

1.  Apps menu
2. "Vehicle"
3. "Driving settings"
4. "Driver assistance"
5. "Parking"
6. "Active PDC emergency braking"
7. Select the desired setting.

Display



As soon as the system intervenes, an icon is displayed with a corresponding message.

System limits

General

Observe the limits of the system in the Chapter "Park assistance systems".

Functional limitations

The system cannot be used in situations such as the following:

- ▶ When driving with a trailer.

If applicable, switch off the system temporarily, if needed.

Drive off monitoring

Principle

If there is a collision risk, start-up monitoring reduces the drive power when driving off.

General

When obstacles are detected in close range in front of the vehicle, the acceleration will be reduced. If necessary, this permits timely manual braking.

When obstacles are detected behind the vehicle, the system will brake.

Follow the information in the Chapter "Parking assistance systems".

Safety information

WARNING

The system does not relieve you of your personal responsibility to assess the traffic situation correctly. Due to system limits, it cannot respond independently and appropriately in all traffic situations. There is a risk of accident. Adapt your driving style to the traffic conditions. Observe the traffic situation, be ready to take over steering and braking at any time, and actively intervene if the situation warrants it.

⚠ WARNING

When the trailer tow hitch is in use, the assistance system cannot react correctly if its sensors are obstructed. There is a risk of accident or material damage. Do not use the assistance system in trailer operation or when using the trailer tow hitch, for example with a rear bicycle carrier.

Sensors

The system is controlled using the following sensors:

- ▷ Ultrasonic sensors in the front/rear bumpers.
- ▷ Side ultrasonic sensors.

Operating requirements

- ▷ Selector lever position D or R is engaged when the vehicle is stationary.
- ▷ Obstacles at close range are detected in front of or behind the vehicle.
- ▷ The accelerator pedal is applied forcefully, almost as far as it will go.
- ▷ The accelerator pedal is applied as soon as the selector lever position is engaged and the obstacle is detected.

Turning start-up monitoring on/off

1.  Apps menu
2. "Vehicle"
3. "Driving settings"
4. "Driver assistance"
5. "Parking"
6. "Drive off monitoring"
7. "Drive off monitoring"

A Check Control message is shown where applicable.

Depending on the national-market version, the system is automatically turned on again at the next drive.

Cancelling reduced drive power

The reduction of the drive power is cancelled in the following situations:

- ▷ The accelerator pedal is released.
- ▷ If the accelerator pedal is pressed twice.
- ▷ A certain distance is travelled.

If the reduction in drive power is cancelled by covering a certain distance, the drive power is released gradually.

Display



As soon as the system intervenes, an icon is displayed with a corresponding message.

System limits

General

Observe the limits of the system in the Chapter "Park assistance systems".

Trailer operation

The system is deactivated when the trailer socket is occupied or when the trailer operation is activated, for example when operating with a trailer or rear bicycle carrier.

Park Assist

Principle

Park Assist provides support when parallel and bay parking.

The system also makes it easier to leave parallel and bay parking spaces.

The ultrasonic sensors measure the surroundings on both sides of the vehicle when driving slowly straight forward. Suitable parking

spaces are calculated based on detected objects, for example, parked vehicles. The status of the system is displayed.

The system calculates the optimum parking line for driving in or out of parking spaces and takes control of the vehicle during the parking manoeuvre.

The operating principle and operation of the system is divided into the following steps:

- ▷ Parking space search.
- ▷ Switch on.
- ▷ Parking.
- ▷ Leaving parking space.

The parking manoeuvre during parking is performed automatically.

When leaving parallel parking spaces, the vehicle manoeuvres automatically until the vehicle reaches a position in which the driver can drive out of the parking space without further steering wheel movements.

When leaving bay parking spaces, the vehicle is manoeuvred completely out of the parking space to enable continued driving in the desired direction.

The Park Assist Professional increases the comfort and range of uses of the Park Assist. In addition to the parking methods of the Park Assist, parking in parking spaces that are marked with lines is possible.

With Park Assist Professional, the parking manoeuvre can be carried out with the Remote Control Parking function from a smartphone.

Vehicle equipment

This system may not be available in the vehicle in question, for example due to the selected optional equipment, the national-market version or the possibility of subsequent enabling and software updates. This also applies to the individual functions of the system.

For further information:

Vehicle equipment, see page 8.

General

Follow the information in the Chapter "Parking assistance systems".

Safety information

WARNING

The system does not relieve you of your personal responsibility to assess the traffic situation correctly. Due to system limits, it cannot respond independently and appropriately in all traffic situations. There is a risk of accident. Adapt your driving style to the traffic conditions. Observe the traffic situation, be ready to take over steering and braking at any time, and actively intervene if the situation warrants it.

WARNING

When the trailer tow hitch is in use, the assistance system cannot react correctly if its sensors are obstructed. There is a risk of accident or material damage. Do not use the assistance system in trailer operation or when using the trailer tow hitch, for example with a rear bicycle carrier.

WARNING

The system can steer the vehicle over or onto kerbs. There is a danger of injury or material damage. Observe the traffic situation and intervene actively if the situation warrants it

Parking methods

Park Assist supports the following functions:

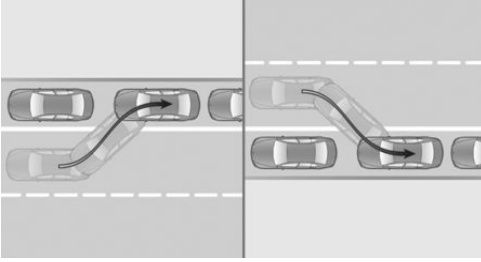

Parallel parking: reverse parking parallel to the road.

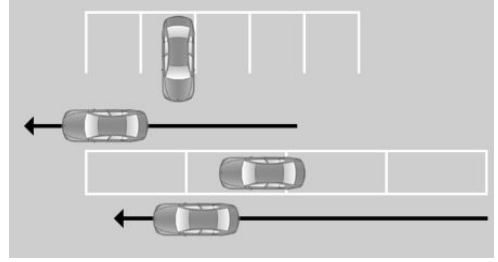

Park Assist Professional: parking in parking spaces with parking lines.

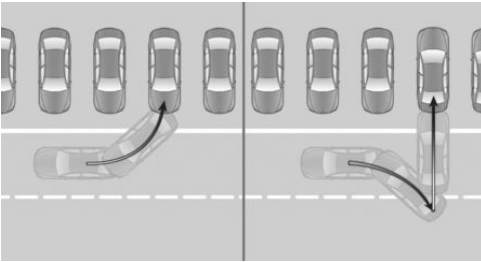

Bay parking: reverse or forward parking perpendicular to the road.

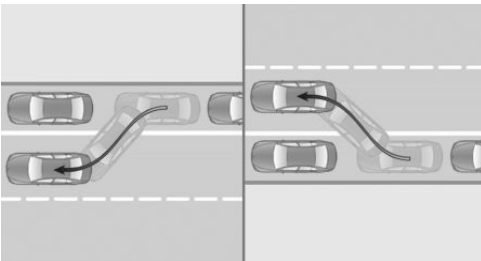

Leaving parallel parking spaces.

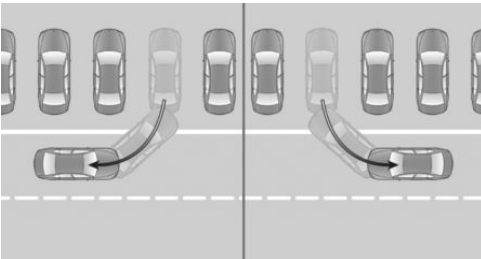

Leaving bay parking spaces.

Sensors

The Park Assist is controlled by the following sensors:

- ▷ Ultrasonic sensors in the front/rear bumpers.
- ▷ Side ultrasonic sensors.

The Park Assist Professional is additionally controlled by the following cameras:

- ▷ Front camera.
- ▷ Exterior mirror camera.
- ▷ Reversing Assist Camera.

Operating requirements

Measurement of parking spaces

- ▷ Driving forwards in a straight line up to a maximum speed of approximately 35 km/h, 22 mph.
- ▷ Maximum distance from the row of parked vehicles: 1.5 m, 5 ft.

Suitable parking space

Parallel parking:

▷ Minimum length of a detected object, for example, a parking vehicle: approx. 1 m, approx. 3 ft.

▷ Minimum length of gap between two objects: own vehicle length plus approximately 0.8 m, 2.6 ft.

▷ Minimum depth: approximately 1.5 m, 5 ft.

Bay parking:

▷ Minimum length of a detected object, for example, a parking vehicle: approx. 1 m, approx. 3 ft.

▷ Minimum width of gap: own vehicle width plus approximately 0.7 m, 2.3 ft.

▷ Minimum depth: own vehicle length.

The depth of bay parking spaces must be estimated by the driver. Due to technical limits, the system is only able to gauge the depth of bay parking spaces approximately.

Parking lines for Park Assist Professional:

The parking space must be clearly marked with lines.

Parking manoeuvre

▷ Doors and luggage compartment are closed.

▷ Driver's seat belt is fastened.

Leaving parking space

▷ The vehicle was parked using the Park Assist and an object is detected in the area around the vehicle.

▷ The vehicle was parked manually in reverse and objects in the immediate vicinity of the vehicle are detected. The distance to a detected kerb is at least 15 cm, approx. 6 in.

▷ The parking space is at least 0.8 m, 2.6 ft longer than the vehicle.

Displays





General

The current status of the parking assistance systems is shown in the right-hand toolbar, in the instrument cluster and, depending on the equipment, in the Head-up display.

Different icons are shown on the control display for selecting the parking method.

The sequence of the displayed icons corresponds to the prioritised parking option.

The direction of the arrow changes in the parking method icons when leaving parallel parking spaces.

Icon	Meaning
	Reverse parallel parking, right.
	Reverse parallel parking, left.
	Reverse bay parking.
	Forward bay parking.

Turning the parking manoeuvre display on/off

When Park Assist is active, the parking manoeuvre is displayed in the camera image on the control display.

1.  Apps menu
2. "Vehicle"
3. "Driving settings"
4. "Driver assistance"
5. "Parking"
6. "Show assistance info"

Switching the acoustic signal on/off

The acoustic signal for suitable parking spaces can be turned on and off.

1.  Apps menu
2. "Vehicle"
3. "Driving settings"

4. "Driver assistance"
5. "Parking"
6. "Sound when available"

Parking with Park Assist

1. For the parking space search, drive past parked vehicles at a speed of up to approx. 35 km/h, approx. 22 mph and a maximum distance of 1.5 m, approx. 5 ft.

 Parking space search is activated.

2. Press the  key or engage reverse gear.

The display of the parking assistance systems is shown.

The status of the parking space search and possible parking spaces are displayed on the control display and in the instrument cluster.

3. On the control display: select an offered parking method. If applicable, another parking method can also be selected afterwards.

In the instrument cluster: select suggested parking method with the knurled wheel on the steering wheel.

 Green: the system takes control of the parking manoeuvre.

4. Follow the instructions on the control display or in the instrument cluster.

The speed can be reduced with the brake. Other interventions will cancel the system.

Depending on the national-market version, an intermittent tone or a continuous tone of the Park Distance Control will sound.

When parking manoeuvre is complete, selector lever position P is engaged.

The end of the parking manoeuvre is indicated on the control display and in the instrument cluster.

5. Adjust the parking position yourself if necessary.

Leaving parking space with Park Assist

1. Switch on drive-ready state.

2.  With the vehicle at a standstill, press the button or engage reverse gear.

The display of the parking assistance systems is shown.

3. On the control display: select the desired parking method.

In the instrument cluster: select suggested parking method with the knurled wheel on the steering wheel.

4. Follow the instructions on the control display or in the instrument cluster.

 Green: the system takes control of the parking manoeuvre.

The speed can be reduced with the brake. Other interventions will cancel the system. A message is displayed at the end of the manoeuvre.

5. Make sure that it is safe to leave the parking space with the given traffic situation, and drive off as usual.

The Park Assist is turned off automatically.

Cancelling Park Assist manually

Park Assist can be cancelled manually at any time, for example:

- ▷ Step lightly on the accelerator pedal twice in succession.
- ▷ Step lightly on the accelerator pedal and move the steering wheel slightly at the same time.
- ▷ Step on the brake pedal and operate the selector lever at the same time.

The Park Assist is cancelled without engaging selector lever position P. Driving can continue immediately.

Cancelling Park Assist automatically

The system automatically cancels in situations such as the following:

- ▷ If the driver grips the steering wheel or steers the vehicle.
- ▷ When operating the accelerator pedal or the selector lever.
- ▷ If the parking brake is applied.
- ▷ When the driver's seat belt is unfastened.
- ▷ With open luggage compartment.
- ▷ With open bonnet.
- ▷ When the doors are open.
- ▷ During activation or intervention by driver assistance systems.
- ▷ If you switch to other functions on the control display.
- ▷ When the display on the control display is faded due to messages.
- ▷ On snow-covered or slippery road.
- ▷ On steep uphill or downhill gradients.
- ▷ If it encounters objects that are difficult to negotiate, for example kerbs.
- ▷ If objects appear suddenly.
- ▷ With insufficient distances, which are indicated by the Park Distance Control.
- ▷ When a maximum number of parking moves or the parking time is exceeded.

When the system is stopped automatically, selector lever position P is engaged.

A Check Control message is shown where applicable.

Continuing the parking manoeuvre

If parking or leaving a parking space has been interrupted, the operation can be continued, if needed.

Switch the Park Assist on again and follow the instructions on the control display or in the instrument cluster.

System limits

General

Observe the limits of the system in the Chapter "Park assistance systems".

No parking assistance

Park Assist does not provide assistance in the following situations:

- ▷ In tight bends.
- ▷ In angled parking spaces.
- ▷ In trailer operation.
- ▷ Park Assist: for parking spaces that are only marked with lines on the ground. The system orients itself on objects.
- ▷ For special parking spaces, for example paid parking spaces with automatic locking mechanisms, or mechanical parking systems.

Functional limitations

The system may have restricted functionality in situations such as the following:

- ▷ On uneven road surfaces, for example gravel roads.
- ▷ On slippery surfaces.
- ▷ On steep uphill or downhill gradients.
- ▷ If leaves have collected or snow has drifted or been piled up in the parking space.

- ▷ If an already measured parking space changes.
- ▷ If there are ditches or sudden drops, for example at a quayside.
- ▷ In some cases, parking spaces may be detected that are not suitable or suitable parking spaces may not be detected.

Malfunction

A Check Control message is shown.

Park Assist has failed. Have the system checked by an authorised Service Partner or another qualified Service Partner or a specialist workshop.

Manoeuvre Assistant

Principle

The Manoeuvre Assistant provides support for recurring parking and manoeuvring situations. Parking and manoeuvring operations can be recorded and then carried out automatically by the system.

Vehicle equipment

This system may not be available in the vehicle in question, for example due to the selected optional equipment, the national-market version or the possibility of subsequent enabling and software updates. This also applies to the individual functions of the system.

For further information:

Vehicle equipment, see page 8.

General

A recurring manoeuvre is driven manually and thereby recorded.

When the vehicle reaches the activation range on the distance covered by the stored manoeuvre, the manoeuvre can be activated on the control display or in the instrument cluster.

After the activation, the system takes control of the vehicle and carries out the manoeuvre automatically.

The manoeuvre can be performed with the Remote Control Parking function using a smartphone.

Follow the information in the Chapter "Parking assistance systems".

Safety information

WARNING

The system does not relieve you of your personal responsibility to assess the traffic situation correctly. Due to system limits, it cannot respond independently and appropriately in all traffic situations. There is a risk of accident. Adapt your driving style to the traffic conditions. Observe the traffic situation, be ready to take over steering and braking at any time, and actively intervene if the situation warrants it.

WARNING

When the trailer tow hitch is in use, the assistance system cannot react correctly if its sensors are obstructed. There is a risk of accident or material damage. Do not use the assistance system in trailer operation or when using the trailer tow hitch, for example with a rear bicycle carrier.

WARNING



The system can steer the vehicle over or onto kerbs. There is a danger of injury or material damage. Observe the traffic situation and intervene actively if the situation warrants it.

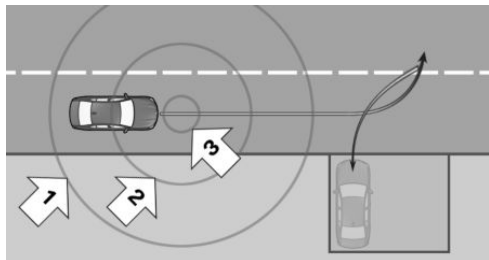

Detection range



The detection range for a manoeuvre is divided into the following areas:

- ▶ Proximity range, arrow 1: the system will begin with the localisation in the background within a range of approx. 8 m/26 ft around the path of a stored manoeuvre.
- ▶  Close range, arrow 2: in a range of approx. 2 m, approx. 6 ft around the path, the stored manoeuvre will be displayed on the control display.
- ▶  Activation range, arrow 3: the stored manoeuvre can be activated on the control display within a range of approx. 1 m, approx. 3.5 ft. After the activation, the system takes control of the vehicle and carries out the manoeuvre automatically.

Sensors

The system is controlled by the following sensors and cameras:

- ▶ Ultrasonic sensors in the front/rear bumpers.
- ▶ Side ultrasonic sensors.
- ▶ Front camera.
- ▶ Exterior mirror cameras.
- ▶ Reversing Assist Camera.

Recording manoeuvre

General

Up to ten manoeuvres can be recorded at different locations.

Up to four overlapping manoeuvres can be recorded.

Identical manoeuvres under different environmental factors can be recorded, for example light conditions.

For each manoeuvre, a maximum distance covered of 200 m/656 ft is possible.

In total, a distance covered of approx. 600 m/approx. 1969 ft distributed to the ten possible manoeuvres can be recorded.

Manoeuvres with a distance covered of less than 6 m/20 ft cannot be recorded.

Recording manoeuvre

1. Drive the vehicle to the starting point from which a manoeuvre must be recorded and stop.



2. Press the button.

The display of the parking assistance systems is shown.

3.  "Record new path"
4. Drive the vehicle to the desired end position.

 The manoeuvre is recorded.

When recording the distance covered, do not drive faster than approx. 15 km/h, approx. 9 mph.

While recording, the distance covered will be displayed.

When the maximum distance covered or the speed is reached, a message will be displayed and an acoustic signal will sound.

5. With a stationary vehicle: "Save recording"
6. "Name:"
If necessary, enter the desired name for the recorded manoeuvre.
7. "Save recording"

Do not move the vehicle until the recording has been stored.

Performing stored manoeuvre

1. Drive the vehicle into the activation range and stop. The control display and instrument cluster indicate that a stored manoeuvre can be activated.

2.  : activate stored manoeuvre.

 Green: after the activation, the system takes control of the vehicle and carries out the manoeuvre automatically. If applicable, follow the instructions on the control display or in the instrument cluster.

The speed can be reduced with the brake. Other interventions will cancel the system.

When parking manoeuvre is complete, selector lever position P is engaged.

Cancelling the Manoeuvre Assistant manually

The vehicle can be controlled manually during an active manoeuvre by taking the following actions:

- ▷ Step lightly on the accelerator pedal twice in succession.
- ▷ Step lightly on the accelerator pedal and move the steering wheel slightly at the same time.
- ▷ Step on the brake pedal and operate the selector lever at the same time.

The Manoeuvre Assistant is cancelled without engaging selector lever position P. Driving can continue immediately.

Cancelling the Manoeuvre Assistant automatically

The system automatically cancels in situations such as the following:

- ▷ If the driver grips the steering wheel or steers the vehicle.
- ▷ When operating the accelerator pedal or the selector lever.
- ▷ When the driver's seat belt is not fastened.

- ▷ With open luggage compartment.
- ▷ With open bonnet.
- ▷ When the doors are open.
- ▷ During activation or intervention by driver assistance systems.
- ▷ When the system limits of the ultrasonic sensors and cameras are reached.
- ▷ If you switch to other functions on the control display.
- ▷ When the display on the control display is faded due to messages.
- ▷ In case of obstacles.
- ▷ On snow-covered or slippery road.
- ▷ When the lane is too narrow.
- ▷ On steep uphill or downhill gradients.
- ▷ In trailer operation.

In the event of an automatic cancellation of the system, the vehicle is decelerated to a complete stop and selector lever position P is engaged.

An interrupted manoeuvre can be continued, if needed. Turn the Manoeuvre Assistant on again and follow the instructions on the control display or in the instrument cluster.

Editing stored manoeuvres

Individual or all manoeuvres can be deleted or renamed.

1.  Apps menu
2. "Vehicle"
3. "Driving settings"
4. "Driver assistance"
5. "Parking"
6. "Recorded paths"
7. Select the desired setting.

System limits

General

Observe the limits of the system in the Chapter "Park assistance systems".

Functional limitations

The system does not provide support in trailer operation.

System limits can cause functional limitations, for example, in the following situations:

- ▷ With poor GPS reception.
- ▷ On steep uphill or downhill gradients.
- ▷ In case of recorded manoeuvres where the system minimum distance to objects cannot be maintained.
- ▷ Greatly deviating conditions when storing and driving the distance covered, for example other tyres or changed environmental factors like light conditions or weather.
- ▷ Delayed display of overlapping stored manoeuvres when driving into the activation range.
- ▷ In multi-storey car parks, for recordings on different parking levels or for recordings that run over several parking levels.

Remote Control Parking

Principle

With the Remote Control Parking function, the vehicle can be driven by remote control in parking and manoeuvring situations of the Manoeuvre Assistant and Park Assist Professional.

The manoeuvre is performed independently outside the vehicle using a smartphone. This makes it easy to get in and out.

In suitable parking spaces, for example, a garage, the parking position can be corrected

with Remote Control Parking through slight manoeuvring.

A manoeuvre that has already begun can be continued at any time with Remote Control Parking.

Vehicle equipment

This system may not be available in the vehicle in question, for example due to the selected optional equipment, the national-market version or the possibility of subsequent enabling and software updates. This also applies to the individual functions of the system.

For further information:

Vehicle equipment, see page 8.

General

Observe the contents in the chapter Park Assist and Manoeuvre Assistant.

Protect the smartphone against unauthorised use.

The low-beam headlights are switched on for the duration of the manoeuvre.

A parking procedure offered by Park Assist Professional is only available for Remote Control Parking for a short time after exiting the vehicle.

Operating requirements

- ▷ All occupants have exited the vehicle.
- ▷ Doors and luggage compartment are closed.
- ▷ The smartphone is compatible with Remote Control Parking.
- ▷ The My BMW App must be installed on a compatible smartphone.
- ▷ The My BMW App must be connected to a ConnectedDrive account.
- ▷ Bluetooth must be activated on the smartphone.

- ▷ The distance between the vehicle and smartphone is no greater than approx. 6 m, approx. 19 ft.
- ▷ A valid digital key must be set up in the vehicle.
For further information:
BMW Digital Key, see page 94.

Performing a parking manoeuvre with Remote Control Parking

1. Engage selector lever in position P.
2. Exit the vehicle and close the doors and luggage compartment.
3. Open Remote Control Parking in the My BMW App and manoeuvre forwards or backwards or select the desired parking method.
4. Follow the instructions on the smartphone.
In the event of obstacles, stop the vehicle manually.
Depending on the selection in the My BMW App, the vehicle is parked at the end of the parking procedure or control of the vehicle can be assumed again.

System limits

Execution of the Remote Control Parking function may be interrupted as a result of environmental factors, for example, an impaired Bluetooth connection due to external interference.

If the power supply of the vehicle battery is not sufficiently ensured, for example due to excessive discharge, remote controlled parking may not be available. Follow the instructions in the My BMW app.

Reversing Assistant

Principle

The Reversing Assistant assists when driving in reverse, for example when driving out of tight or confusing parking or street situations.

Vehicle equipment

This system may not be available in the vehicle in question, for example due to the selected optional equipment, the national-market version or the possibility of subsequent enabling and software updates. This also applies to the individual functions of the system.

For further information:

Vehicle equipment, see page 8.

General

The vehicle saves the driving movements for the last distance covered. This stored distance can be driven back with automated steering.

The system takes control of the steering. The speed must be controlled by the driver using the accelerator pedal and the brake.

Reversing Assistant: a maximum of 50 m, approx. 164 ft is stored.

Reversing Assistant Professional: a maximum of 200 m, approx. 656 ft is stored.

Follow the information in the Chapter "Parking assistance systems".

Safety information

WARNING

The system does not relieve you of your personal responsibility to assess the traffic situation correctly. Due to system limits, it cannot respond independently and appropriately in all traffic situations. There is a risk of accident. Adapt your driving style to the traffic conditions. Observe the traffic situation, be ready to take over steering and braking at

any time, and actively intervene if the situation warrants it.

⚠ WARNING

When the trailer tow hitch is in use, the assistance system cannot react correctly if its sensors are obstructed. There is a risk of accident or material damage. Do not use the assistance system in trailer operation or when using the trailer tow hitch, for example with a rear bicycle carrier.

⚠ WARNING

The system can steer the vehicle over or onto kerbs. There is a danger of injury or material damage. Observe the traffic situation and intervene actively if the situation warrants it

Operating requirements

- ▶ To save the distance covered, drive forwards without interruption.
- ▶ To store the distance covered, do not drive faster than 35 km/h/22 mph.
- ▶ No trailer operation.
- ▶ Reversing Assistant Professional: sufficiently bright light conditions on the stored distance covered.
- ▶ Reversing Assistant Professional: the cameras on the vehicle must be clean and clear.

Reversing with automated steering

1. Switch on drive-ready state.



2. With the vehicle at a standstill, press the button or engage reverse gear.

The display of the parking assistance systems is shown.

3. "Start Reversing Assistant"

The length of the distance covered is displayed on the control display and in the instrument cluster.

If applicable, follow the instructions on the control display or in the instrument cluster.

4. Take your hands off the steering wheel and carefully drive in reverse with the accelerator pedal and the brake.

Green: the system takes control of the steering.

When driving in reverse, observe the vehicle surroundings.

In case of obstacles, stop immediately and take over control of the vehicle. Pay attention to the information on Park Distance Control.

5. Shortly before the end of the stored distance covered, an acoustic signal will sound and a message is displayed.

Stop when you reach normal road traffic at the latest and take over control of the vehicle, for example by engaging a forward gear.

Cancelling the Reversing Assistant manually

The assisted reversing by the Reversing Assistant can be cancelled manually:

- ▶ "Cancel"
- ▶ Press the key.

Cancelling the Reversing Assistant automatically

The system automatically cancels in situations such as the following:

- ▶ If the driver grips the steering wheel or steers the vehicle.
- ▶ When shifting from reverse gear to another selector lever position.

- ▶ During activation or intervention by driver assistance systems.
 - ▶ After an extended period of time when the vehicle is stationary.
 - ▶ When exiting the stored lane when reversing, for example with a maximum steering wheel angle.
 - ▶ When the display on the control display is faded due to messages.
 - ▶ In case of a slippery surface.
 - ▶ When the vehicle is rolling, for example on a slope.
 - ▶ In case of changed environmental factors.
 - ▶ When the trailer socket is occupied or trailer operation is activated.
 - ▶ At speeds over approximately 10 km/h, 6 mph.
 - ▶ Reversing Assistant Professional: in the event of functional limitations of the sensors from approx. 50 m, approx. 164 ft.
- ple, different tyres or changed environmental factors like the weather.
- ▶ Reversing Assistant Professional: when light conditions change.
- Also observe the limits of the system in the chapter "Parking assistance systems".

System limits

- ▶ The maximum speed when driving in reverse is limited to approx. 10 km/h, approx. 6 mph.
A warning occurs at a speed of approx. 7 km/h, approx. 4 mph.
If the maximum speed is exceeded, the function is interrupted.

Various factors can cause the vehicle to deviate sideways when reversing along the saved distance covered. These factors include, for example:

- ▶ If the steering wheel is moved with the vehicle stationary while the distance covered is being saved.
- ▶ The speed is not adapted to the distance covered in question.
- ▶ Certain road characteristics, for example gradients, inclines or slippery road surface.
- ▶ Greatly deviating conditions when storing and driving the distance covered, for exam-



Driving comfort

Vehicle equipment

This chapter describes equipment, systems and functions which are offered or may be offered in future on a model-specific basis, even if they are not included in the vehicle in question.

For further information:

Vehicle equipment, see page [8](#).

Adaptive suspension Professional

The Adaptive suspension Professional is an actively controlled suspension and includes the following systems:

- ▶ Adaptive suspension, see page [290](#).
- ▶ Integral Active Steering, see page [226](#).

Adaptive suspension

Principle

The suspension reduces body movements with a sporty driving style or on an uneven road.

General

The active shock absorbers increase vehicle driving dynamics and enhance driving comfort, depending on the road conditions, driving style, and the drive mode selected.

- ▶ SPORT drive mode: increased driving dynamics to support a sporty driving style.
- ▶ All other drive modes: support for a comfortable driving style.

BMW IconicSounds

Depending on the equipment and national-market version, the drive sound of the vehicle can be adjusted with BMW IconicSounds.

1.  Apps menu
2. "Vehicle"
3. "Driving settings"
4. "Drivetrain and chassis"
5. "IconicSounds"
6. Select the desired setting.

Air conditioning

Vehicle equipment

This chapter describes equipment, systems and functions which are offered or may be offered in future on a model-specific basis, even if they are not included in the vehicle in question.







For further information:







Vehicle equipment, see page 8.

Air conditioning control

Overview



Functions in the air conditioning menu

Icon	Function
	Switching the air conditioning system on/off
	Automatic programme.
	Temperature.
	Air conditioning function.
	Maximum cooling.
	Air recirculation function.
	Automatic air recirculation control.



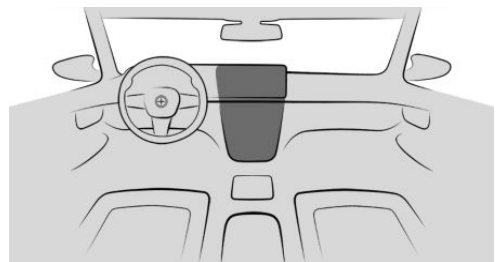

Icon	Function
	Fresh air.
	Amount of air.
	Air distribution.
	SYNC programme.
	Seat heating.
	Active seat ventilation.
	Steering wheel heating.

Buttons, integrated automatic heating/air conditioning system



Icon	Function
	Defrost function.
	Rear window heating.

Automatic rear air conditioning system

Icon	Function
	Automatic programme.
	Temperature.
	Amount of air.
	Air distribution.
	Seat heating.

Go to air conditioning functions

The Climate menu can be accessed via iDrive:



-  Tap the icon for the Climate menu in the menu bar.

Or:

-  Apps menu
- "Vehicle"
- "Climate control"

Turning the air conditioning system on/off

The air conditioning system can be switched on or off using iDrive.

-  Tap the icon for the Climate menu in the menu bar.
-  Tap the button for switching on and off.

The complete air conditioning system is switched on or off with the last settings.

When the air conditioning system is turned on, individual air conditioning functions can be turned off.

Settings

Individual settings for the air conditioning functions can be made via iDrive, for example:

- ▷ Intensity of the seat heating.
- ▷ Pre-cooling.

-  Tap the icon for the Climate menu in the menu bar.
- "Individual settings" or "General settings"
- Select the desired setting.

Turning automatic rear air conditioning system on/off

Operating requirements

- ▷ Automatic air conditioning is turned on.
- ▷ Defrost function is deactivated.

Via iDrive

-  Tap the icon for the Climate menu in the menu bar.
- "Individual settings"

3. "Second row of seats"
4. "Rear climate control"
5. Select the desired setting.

The automatic rear air conditioning system can be activated with the default setting for temperature and AUTO programme:

"Activate with default settings"

Locking the automatic rear air conditioning system



1.  Tap the icon for the Climate menu in the menu bar.
2. "Individual settings"
3. "Second row of seats"
4. "Lock rear climate control"

Automatic programme

Principle

The automatic programme ensures a comfortable climate, which can be modified with the set temperature and individual settings.

The automatic programme cools, ventilates, or heats the vehicle interior automatically.

General

Depending on vehicle equipment, the automatic programme provides the best possible settings for air conditioning functions depending on the outside temperature, interior temperature, sunlight, seat occupancy, and the desired temperature setting:

- ▶ Amount of air.
- ▶ Air distribution.
- ▶ Temperature.
- ▶ Seat heating.
- ▶ Active seat ventilation.
- ▶ Steering wheel heating.

The automatic programme takes the seat occupancy into account to ensure energy-efficient control adapting to the vehicle passengers.

At the same time, a condensation sensor controls the automatic programme in such a way that condensation is avoided as far as possible.

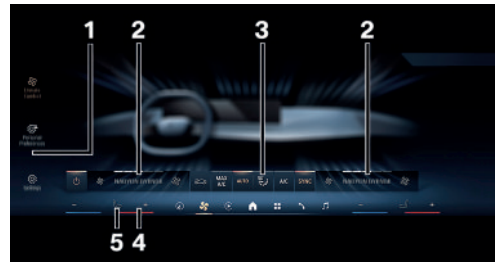

Overview



- 1 Settings
- 2 Air intensity
- 3 Air conditioning functions bar
- 4 Temperature
- 5 Seat heating
Steering wheel heating
Active seat ventilation

Switching the automatic programme on/off

The automatic programme can be switched on or off using iDrive.

1.  Tap the icon for the Climate menu in the menu bar.
2.  Tap the button for the automatic programme.

Switching the automatic rear air conditioning system programme on/off

Via iDrive



1. Tap the icon for the Climate menu in the menu bar.
2. "Individual settings"
3. "Second row of seats"
4. "Automatic programme"
5. Select the desired setting.

Via rear air conditioning display



Tap the button.

Setting the intensity

When the automatic programme is activated, the intensity of individual climate comfort functions, for example, the seat heating, can be individually adjusted.



1. Tap the icon for the Climate menu in the menu bar.
2. "Individual settings"
3. Select the desired setting; for example:
 - ▷ "LOW"
 - ▷ "MEDIUM"
 - ▷ "HIGH"

Each level has a specific control range of the intensity.

Based on the stored data models, the intensities are dynamically adjusted during the journey. It is not necessary to manually change the desired intensity to lower or higher levels while driving.

The individually selected settings of the air conditioning functions are stored and automat-

ically set up again, for example, after the vehicle is started again.

Display

The indicator in the menu bar provides information about the temperature differential between the set desired temperature and current interior temperature:

- ▷ The red or blue bar next to the temperature display indicates the progress of heating up or cooling.
- ▷ The desired interior temperature is reached as soon as the bar is no longer displayed.

Active air conditioning functions, for example seat heating, are displayed as an icon in the menu bar.

Temperature

Principle

The automatic air conditioning cools or heats to the set temperature and then keeps the temperature constant.

General

Avoid switching between different temperature settings in rapid succession. The automatic air conditioning may not have sufficient time to adjust to the set temperature.

Adjusting the temperature



The desired temperature can be set individually in the menu bar for the driver and front passenger.

- ▷ + Increase the temperature.
- ▷ - Reduce the temperature.

Setting the automatic rear air conditioning system temperature

Via iDrive

1.  Tap the icon for the Climate menu in the menu bar.
2. "Individual settings"
3. "Second row of seats"
4. Set the desired temperature.

Via rear air conditioning display

The temperature can be set individually for the driver's side and passenger's side.

Set the desired temperature:

- ▷ + Increase the temperature.
- ▷ - Reduce the temperature.

Footwell temperature

General

The air temperature in the footwell can be adjusted.

The set interior temperature for driver and front passenger is not changed by this.

Adjusting the footwell temperature

1.  Tap the icon for the Climate menu in the menu bar.
2. "Individual settings"
3. "Driver" or "Front passenger"
4. "Temperature adjustment for footwell"
5. Increase or decrease the temperature.

Amount of air

General

The blower-generated air flow can be adjusted individually as needed.

Adjusting the amount of air

The amount of air can be set using iDrive.

1.  Tap the icon for the Climate menu in the menu bar.

The amount of air may be reduced in order to save the vehicle battery power.

Adjusting the amount of air of the automatic rear air conditioning system

1.  Tap the icon on the rear air conditioning display to set the desired intensity.



Air distribution

Principle

In manual mode, the air distribution can be adjusted as required.

Adjusting the air distribution

The air distribution can be set using iDrive.

1.  Tap the icon for the Climate menu in the menu bar.
2.  Tap the air distribution icon in the Air conditioning functions bar.
3. Select the desired setting:
 - ▶ Direct the air flow downwards, arrow 1.
 - ▶ Direct the air flow upwards, arrow 2.
 - ▶ Direct the air flow to the windscreen, arrow 3.

The selected air distribution is displayed.

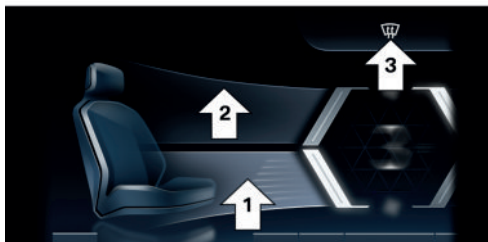

Adjusting the air distribution, automatic rear air conditioning system

1.  Tap the icon on the rear air conditioning display to set the desired air distribution.

Air conditioning function

Principle



With the cooling function, the air in the interior is cooled, dried and then heated again depending on the temperature setting.

Operating requirements

Standby state or drive-ready state is switched on.

Switching the cooling function on/off

The cooling function can be switched on or off via iDrive:

1.  Tap the icon for the Climate menu in the menu bar.
2.  Tap the button for the cooling function.

The air conditioning function is switched on automatically when the air recirculation function is operating in order to dry the air and prevent condensation.

Depending on the weather conditions, the windscreen and the side windows may mist over for a short time after switching on drive-ready state.

Cooling produces condensation, which then exits underneath the vehicle.

Maximum cooling

Principle

The maximum cooling enables quick and intense cooling of the interior.

The lowest temperature and maximum amount of air are set automatically.



This function is automatically activated in the rear when the SYNC programme is turned on.

Operating requirements

The function is available at an outside temperature above approximately 0 °C, 32 °F and when drive-ready state is switched on.

Turning maximum cooling on/off

Maximum cooling can be switched on or off via iDrive:

1.  Tap the icon for the Climate menu in the menu bar.
2.  Tap the button for maximum cooling.

The air flows from the air vents for the upper body area. Open the vents.

Air recirculation function

Principle

If the air outside the vehicle has an unpleasant odour or contains pollutants, the supply of outside air into the interior of the vehicle can be shut off. The interior air is then recirculated.

In the automatic recirculated-air control, outside air is drawn in or the interior air is circulated, depending on the outside air quality.

When the air recirculation function is turned off, outside air is directed into the interior.





General

If there is condensation, switch off the air recirculation function.

The interior filter cleans the incoming outside air or the circulated inside air in air recirculation mode.

Turning the air recirculation function on/off

The air recirculation function can be switched on or off via iDrive:

1.  Tap the icon for the Climate menu in the menu bar.
2. The current operating mode is displayed in the air conditioning functions toolbar. Tap the button until the desired operating mode is set.
 - ▶  Air recirculation.
 - ▶  Fresh air.
 - ▶  Automatic air recirculation control.

The air conditioning function is switched on automatically when the air recirculation function is operating in order to dry the air and prevent condensation.

Depending on the equipment, the air recirculation function will turn off automatically after some time depending on the environmental factors to prevent condensation.

SYNC programme

Principle

If the SYNC programme is activated, settings on the driver's side are transferred to the passenger's side and to the rear.

If the SYNC programme is deactivated, the following settings are applied automatically with the automatic programme, depending on seat occupancy:

- ▶ If the front passenger seat is not occupied, the settings for the driver's side are applied.
- ▶ The default settings are applied to unoccupied seats in the rear.



General

The following settings can be transferred:

- ▶ Temperature.
- ▶ Amount of air.
- ▶ Air distribution.
- ▶ Automatic programme.

Turning the SYNC programme on/off

The SYNC programme can be switched on or off via iDrive:

1.  Tap the icon for the Climate menu in the menu bar.
2.  Tap the button for the SYNC programme.

If the settings on the passenger side or in the rear are changed, the programme is automatically switched off.

Defrost function

Principle

With the defrost function, ice and condensation are quickly removed from the windscreen and the front side windows.

The amount of air and air temperature are automatically optimised for the removal of ice and condensation.

The air distribution is directed towards the windscreen and the front side windows.

If there is condensation, turn on the automatic programme to utilise the advantages of the condensation sensor.

When the defrost function is switched on, the automatic rear air conditioning system is deactivated to provide maximum power.

Turning the defrost function on/off



Press the defrost button on the instrument panel.

The LED in the button is illuminated when the system is switched on.

When the defrost function is switched on, the automatic rear air conditioning system is deactivated to provide maximum power.

Check that air can flow to the windscreen and front side windows.

Rear window heating

Principle

With the rear window heating, ice and condensation are quickly removed from the rear window.

Operating requirements

Standby state or drive-ready state is switched on.

Turning the rear window heating on/off



Press the rear window heating button on the instrument panel.

The LED is illuminated when the rear window heating is switched on.

The rear window heating switches off automatically after a while.

Seat heating

Principle

The system heats the seats if necessary.

General

If a drive is resumed within about 15 minutes after a temporary stop, the functions are automatically switched on at the last temperature setting.

Adjusting the seat heating

Automatic programme

When the automatic programme is activated, the intensity of seat heating can be adjusted. The heating power is automatically adjusted according to the set intensity during the course of the journey.

Adjusting the seat heating manually

The heat output level can be adjusted manually:

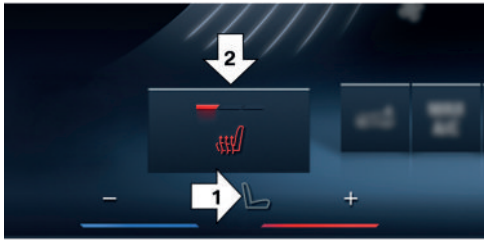

1. Tap the icon for seat climate control in the menu bar, arrow 1.

2.  Press the button for the seat heating repeatedly until the desired level is selected, arrow 2.

If a drive mode for a consumption-optimised driving style is selected, the heater output is reduced.

Switching the seat heating for the rear automatic climate control on/off



Tap the icon on the rear air conditioning display to set the desired heating output level.

Active seat ventilation

Principle

The system cools the seat and backrest surfaces if required and ensures a pleasant seating climate.

Adjusting active seat ventilation

Automatic programme

When the automatic programme is activated, the intensity of the seat ventilation can be adjusted. The ventilation is automatically adjusted according to the set intensity during the course of the journey.

Adjusting the active seat ventilation manually

The ventilation level can be adjusted manually:



1. Tap the icon for seat climate control in the menu bar, arrow 1.

2.  Press the button for the seat ventilation repeatedly until the desired level is selected, arrow 2.

Steering wheel heating

Principle

The system heats the steering wheel if necessary.

Adjusting the steering wheel heating

Automatic programme

When the automatic programme is activated, the intensity of the steering wheel heating can be adjusted. The heating power is automatically adjusted according to the set intensity during the course of the journey.

Adjusting the steering wheel heating manually

The heat output level can be adjusted manually:



1. Tap the icon for seat climate control in the menu bar, arrow 1.



2. Press the button for the steering wheel heating repeatedly until the desired level is selected, arrow 2.

If a drive mode for a consumption-optimised driving style is selected, the heater output is reduced.

Ventilation

Principle

The ventilation system provides individual ranges of adjustment for direct or indirect ventilation to optimise the movement of air inside the vehicle.

General

Open the air vents and position them in a way that ensures effective climate control.

The air flow heats or cools noticeably, depending on the set temperature.

Ventilation at front



- ▷ Change in air flow direction, arrows 1.
- ▷ Adjustment of the amount of air at the air vent, arrows 2.

Ventilation in rear passenger compartment

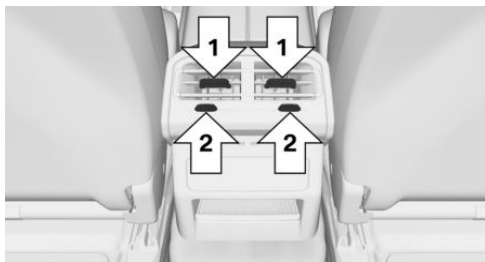

- ▷ Change in air flow direction, arrows 1.
- ▷ Knurled wheel for steplessly opening and closing the air vents, arrows 2.

Ventilation in the rear, side

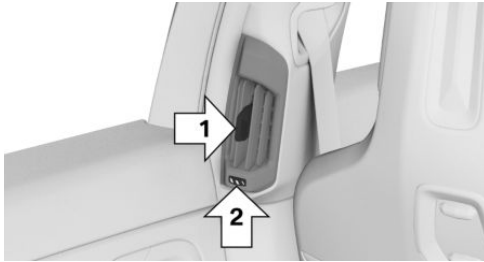

- ▷ Lever for changing the air flow direction, arrow 1.
- ▷ Knurled wheel for steplessly opening and closing the air vents, arrow 2.

Adjusting the ventilation

Depending on the set ventilation, align the air flow directly or indirectly toward the passengers.

Air quality

General

The air quality in the interior is improved by the following components:

- ▷ Emissions-tested interior.
- ▷ Interior filter.
- ▷ Climate control system for regulating temperature, amount of air and air recirculation function.
- ▷ Pre-cooling.

Interior filter

The interior filter cleans the incoming outside air or the circulated inside air in air recirculation mode.

Depending on the equipment:

- ▷ Dust and pollen are filtered out from the inflowing outside air.
- ▷ Nano-particle emissions are reduced.

- ▷ Gaseous pollutants are filtered.
- ▷ Microbial particles, viruses, and allergens are filtered.

The vehicle manufacturer recommends having the interior filter replaced when the vehicle is serviced.

Pre-cooling/pre-heating

Principle

The system consists of the pre-cooling and pre-heating functions. It allows the temperature of the interior to be adjusted before the journey starts. The interior is ventilated or heated depending on the set temperature and ambient temperature. When doing so, the system uses any available residual heat from the engine or the vehicle's fuel for generating heat.

General

The system can be switched on and off directly or for a preselected departure time.

The switch-on time is calculated based on the outside temperature. The system will switch on in good time before the preselected departure time.

The system switches off automatically after a while. It continues to run for a short time after it has been switched off.

If outside temperatures are below 0 °C, 32 °F, water vapour condenses and exits underneath the vehicle.

Safety information

DANGER

A blocked exhaust pipe or inadequate ventilation can allow harmful exhaust fumes to enter the vehicle. The exhaust fumes contain pollutants which are colourless and odourless. In enclosed spaces, exhaust fumes can also build up outside the vehicle. There is

a danger to life. Keep the exhaust pipe clear and ensure sufficient ventilation. Do not switch on the pre-heating in enclosed spaces, for example closed garages.

 **WARNING**

When the pre-heating is operating, high temperatures can be generated under the body, for example because of the exhaust system. If flammable materials come into contact with hot parts of the exhaust system, these materials may ignite. There is a risk of fire. Make sure that no flammable materials, for example leaves, grass, gas, petrol, oil or other flammable objects, can come into contact with vehicle parts when the pre-heating is operating. Switch off the pre-heating before refuelling.

Operating requirements

- ▷ The vehicle is in rest state or standby state.
- ▷ The vehicle battery must be sufficiently charged.

When activated, the pre-cooling/pre-heating uses power from the vehicle battery. As a result, the maximum operating time is restricted to protect the vehicle battery. After the engine is started or after driving a short distance, the system will be available again.

- ▷ For pre-heating: the fuel tank capacity is sufficient.

If the fuel tank capacity is low and the vehicle is parked on a slant, the pre-heating function may be restricted.

- ▷ Time and date are set correctly.
- ▷ The air vents of the ventilation are open.

Turning the pre-cooling/pre-heating on/off



1. Tap the icon for the Climate menu in the menu bar.
2. "General settings"
3. "Pre-heating/cooling"
4. Select the desired setting.

Departure time

General

To ensure a pleasant interior temperature in the vehicle at the start of the journey, it is possible to set different departure times.

- ▷ One-off departure time: the time can be set. The system is activated once.
- ▷ Departure time with day of the week: the time and day of the week can be set. The system is switched on before the set departure time on the required days of the week.

Preselection of departure time is done in two stages:

- ▷ Set the departure times.
- ▷ Activate the departure time.

At least 10 minutes should pass between setting/activating the departure time and the scheduled departure time, so the climate control has enough time to work.

Setting the departure time



1. Tap the icon for the Climate menu in the menu bar.
2. "General settings"
3. "Pre-heating/cooling"
4. "Departure plan"
5. Select the required departure time.



6. Set the desired departure time.
7. Select the day of the week if necessary.

Activating the departure time



1. Tap the icon for the Climate menu in the menu bar.
2. "General settings"
3. "Pre-heating/cooling"
4. "Departure plan"
5. Activate the required departure time.

Display

Icon	Description
	Icon on instrument panel. Icon illuminates: the pre-heating is switched on.
	Icon on instrument panel. Icon is illuminated: a departure time is activated. Icon flashes: the pre-cooling is turned on.

Activating with the My BMW App

Depending on the equipment, the My BMW App with remote function can be used to switch on the pre-cooling/heating via a pre-selected departure time or directly.

Pre-conditioning via Remote Engine Start

Principle

Pre-conditioning cools or warms the interior to a comfortable temperature before the start of a journey. The system does this by automatically cooling, ventilating or heating depending on the internal, external and set desired tem-

perature. Any snow and ice can be removed more easily.

The system starts the engine automatically for this purpose and lets it run for a limited time.

Safety information

DANGER

A blocked exhaust pipe or inadequate ventilation can allow harmful exhaust fumes to pollute the area around the vehicle or enter it. The exhaust fumes contain pollutants which are colourless and odourless. In enclosed spaces or spaces with inadequate ventilation, the exhaust fumes can also build up outside the vehicle. There is a danger to life. Keep the exhaust pipe clear and ensure sufficient ventilation. Do not switch on the pre-conditioning in enclosed or poorly ventilated spaces, for example closed garages.

WARNING

When the pre-conditioning is operating, high temperatures can be generated under the body, for example because of the exhaust system. If flammable materials come into contact with hot parts of the exhaust system, these materials may ignite. There is a risk of fire. Make sure that no flammable materials, for example leaves, grass, gas, petrol, oil or other flammable objects, can come into contact with vehicle parts when the pre-conditioning is operating.

Operating requirements

- ▷ The vehicle is in rest state or standby state.
- ▷ Battery must be sufficiently charged.
- ▷ Fuel tank capacity is sufficient.
- ▷ Bonnet is closed.



- ▶ Ensure that the date and time are set correctly in the vehicle.
- ▶ Ventilation air vents are open.

Enabling automatic engine start

The automatic engine start must be enabled before using the system. This enables the engine to switch on automatically in order to control the interior climate.



1. Tap the icon for the Climate menu in the menu bar.
2. "General settings"
3. "Pre-conditioning"
4. "Remote Engine Start"
5. "Start engine for climate cont."
6. Confirm the disclaimer.

Turning on/turning off the pre-conditioning

General

For safety reasons, the system switches off automatically after 15 minutes at the latest.

The system can be switched on a maximum of twice in succession.

The system will be available again once the drive-ready state has been activated and deactivated again.

Switching on via iDrive



1. Tap the icon for the Climate menu in the menu bar.
2. "General settings"
3. "Pre-conditioning"
4. "Start now"

Switching on/off using the vehicle key

The system can be switched on and off using the vehicle key.



Press the vehicle key button three times within 1 second.

After the vehicle key is pressed, it will take around 3 seconds for the engine to switch on.

To switch the system off, press the button again three times.

Switching off using the Start/Stop button

The system can be switched off directly by pressing the Start/Stop button without depressing the brake pedal.

Air conditioning for departure time

General

To ensure a pleasant interior temperature in the vehicle at the start of the journey, it is possible to set scheduled departure times in the system.

- ▶ One-off departure time: the scheduled departure time can be set.
The system is switched on as a one-off.
- ▶ Departure time with day of the week: the scheduled departure time and day of the week can be set.

Preselection of departure time is done in two stages:

- ▶ Set the departure times.
- ▶ Activate the departure time.

The system is automatically activated a few minutes before the set departure time. The system remains switched on until just after the set departure time.

For safety reasons, climate control for departure time is only possible once.

The system will be available again once the drive-ready state has been activated and deactivated again.

Observe the information regarding the intended use of the vehicle.

For further information:

Your own safety, see page 9.

Setting the departure time



1. Tap the icon for the Climate menu in the menu bar.
2. "General settings"
3. "Pre-conditioning"
4. "Departure plan"
5. Set the departure time.
6. Select the day of the week if necessary.

Activating the departure time



1. Tap the icon for the Climate menu in the menu bar.
2. "General settings"
3. "Pre-conditioning"
4. "Departure plan"
5. Activate the required departure time.

Display

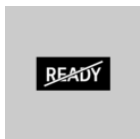

In the instrument cluster:

The engine runs for the purpose of operating the pre-conditioning. The vehicle is not ready to drive.

Icon	Description
	Icon on instrument panel. Icon is illuminated: a departure time is activated. Icon flashes: the pre-conditioning is turned on.

Vehicle acknowledgement signals

The system switch-on is acknowledged by two flashes.

The side lights remain switched on while the system is switched on.

Interior equipment

Vehicle equipment

This chapter describes equipment, systems and functions which are offered or may be offered in future on a model-specific basis, even if they are not included in the vehicle in question.

For further information:

Vehicle equipment, see page 8.

Integrated universal remote control

Principle

The integrated universal remote control in the interior mirror can operate remote-controlled systems, for example, garage door openers, alarm systems or locking systems.

General

The integrated universal remote control replaces up to three different hand-held transmitters. To use the opener, the buttons on the interior mirror must be programmed with the desired functions.

If you sell the vehicle, delete the saved functions beforehand for your own safety.

If possible, do not install the aerial of the remote-controlled system near metal objects to ensure the best possible operation.

Safety information

WARNING

Parts of the body can be trapped when operating radio-controlled systems, for example a garage door, with the integrated universal remote control. There is a danger of injury

or material damage. During programming and operation, make sure that the movement range of the system concerned is kept clear. Also follow the safety notes supplied with the hand-held transmitter.

Compatibility

The integrated universal remote control does not support the frequency band 27 MHz to 40 MHz.



If this icon is printed on the packaging or in the operating instructions of the remote-controlled system, the system is generally compatible with the integrated universal remote control.

A list of compatible hand-held transmitters is available on the Internet: www.homelink.com

HomeLink is a registered trademark of Gentex Corporation.

Additional questions can be answered by an authorised Service Partner or another qualified Service Partner or a specialist workshop.

Operating elements on the interior mirror



- ▷ Buttons, arrow 1.
- ▷ LED, arrow 2.
- ▷ Hand-held transmitter of the remote-controlled system, arrow 3.

Programming the integrated universal remote control

Operating requirements

The battery in the hand-held transmitter must be fully charged during programming to ensure the integrated universal remote control will have the optimum range.

Programming individual buttons

1. Park your vehicle within the range of the radio remote-controlled system.
2. Switch on standby state.
3. Select desired button on the interior mirror:
 - ▶ Program available button:
Press the key.
 - ▶ Program already assigned button:
Press and hold the button for approx. 20 seconds.

The LED on the interior mirror flashes orange slowly.

4. Hold the hand-held transmitter for the remote-controlled system approx. 2.5 to 30 cm, 1 to 12 in away from the buttons on the interior mirror.
The distance required depends on the hand-held transmitter.
5. Press and hold the button on the hand-held transmitter.
6. The LED can illuminate in various ways:
 - ▶ The LED is illuminated green: programming is complete.
Release button.
 - ▶ The LED flashes green rapidly: the hand-held transmitter was detected but programming is not complete.
Press and hold the button on the interior mirror for approx. 2 seconds. Perform this procedure three times.
If the integrated universal remote control remains non-operational, continue

with the special features for alternating-code radio systems.

- ▶ LED does not illuminate green after 60 seconds: programming not completed.
Repeat steps 3 to 5.

Special instruction for alternating-code radio systems

For systems with an alternating-code radio system, the integrated universal remote control and the system must also be synchronised.

Refer to information on synchronisation in the operating instructions of the remote-controlled system.

1. Program the desired button on the interior mirror.
2. Locate and press the synchronising button on the remote-controlled system, for example, on the garage door.

The next step must be carried out within approximately 30 seconds.

To make synchronisation easier, enlist the assistance of a second person.

3. Press and hold the programmed button on the interior mirror for approx. 3 seconds.
Repeat this step as needed up to three times to end synchronisation. When synchronisation is completed, the programmed function is performed.

Operation

After programming, the remote-controlled system can be operated with the button on the interior mirror.

Press and hold the desired button of the remote-controlled system within range until the function is triggered.

The LED on the interior mirror is continuously illuminated green during the transmission of the radio signal.

Deleting a button assignment

The button assignment cannot be deleted individually.

Press and hold the two outer buttons on the interior mirror simultaneously for approximately 10 seconds until the LED flashes green rapidly.

All stored button assignments will be deleted.

Sun visor

Glare protection

Fold the sun visor downwards or upwards.

Protection from glare at the side

Folding the sun visor out

1. Fold down the sun visor.
2. Detach the sun visor from its holder and pivot it sideways to the side window.

Folding the sun visor in

To close the sun visor, proceed in reverse order.

Vanity mirror

A vanity mirror is located behind a cover in the sun visor.

Sockets

Principle

The socket can be used for electronic devices when the standby or drive-ready state is switched on.

General

The total load of all sockets must not exceed 140 watts at 12V.

Do not damage the socket by using unsuitable connectors.

Safety information

WARNING

Devices and cables, for example portable navigation devices, that are located in the deployment range of the airbags may impede airbag deployment or be thrown around the vehicle interior when the airbag is deployed. There is a danger of injury or material damage. Make sure that devices and cables are not in the deployment range of the airbags.

WARNING

Battery chargers that charge the vehicle battery via sockets or cigarette lighters in the vehicle may overload or damage the 12V electrical system. There is a danger of injury or material damage. Only connect battery chargers for the vehicle battery to the starting aid terminals in the engine compartment.

WARNING

If metallic objects fall into the socket, they can cause a short circuit. There is a danger of injury or material damage. After using the socket, re-fit the cigarette lighter or socket cover.

Front centre armrest

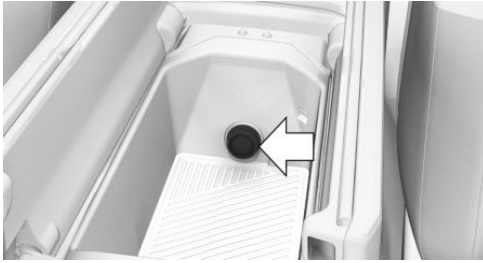

There is a socket in the centre armrest.

USB port

General

Please comply with the notes on connecting mobile devices to the USB port in the chapter on USB connections.

For further information:

For information on USB connection, see Owner's Handbook for Navigation, Entertainment, Communication.

In the front centre console

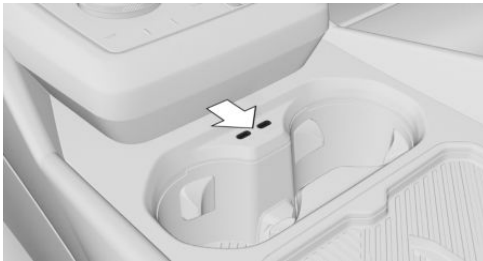

There are two USB ports in the centre console.

Properties:

- ▶ USB port type C.
- ▶ For charging mobile devices and transferring data.
- ▶ Charge current: maximum 3 A per port.

In the rear centre console

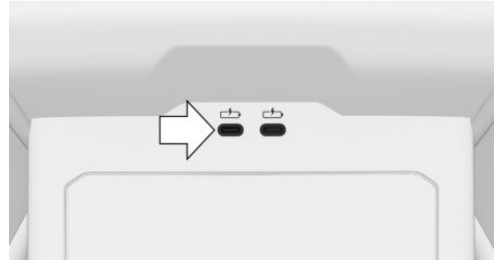

There are two USB ports in the rear centre console.

Properties:

- ▶ USB port type C.
- ▶ For charging mobile devices.
- ▶ Charge current: maximum 3 A per port.

BMW Travel & Comfort System

General

USB connections and mounts for mounting optional accessories, e.g. universal holders for tablets or clothes hangers are located on the backrests of the front seats.

USB port properties:

- ▶ USB port type C.
- ▶ For charging mobile devices.
- ▶ Charge current: maximum 3 A / 45 W per seat.

Additional information is available from an authorised Service Partner or another qualified Service Partner or a specialist workshop.

Overview

Depending on the equipment:

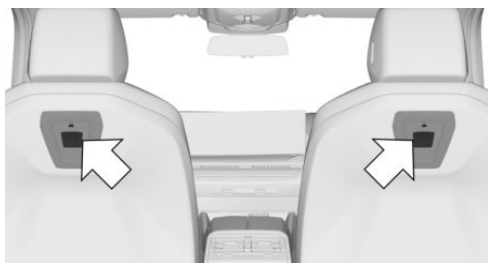

The fixtures are located behind the marked covers.

The USB ports are located behind the marked covers.

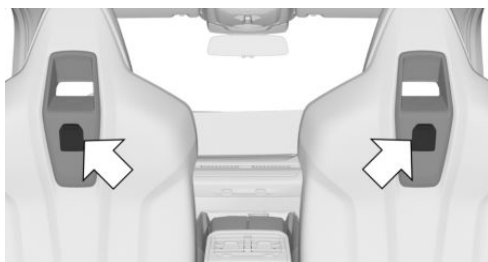

The sockets and the USB ports are located behind the marked covers.

Installing optional accessories

Depending on the equipment:

1. Slide the cover down.

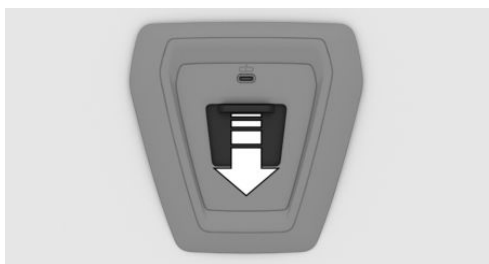

2. Fit optional accessories, see installation instructions.

1. Slide the cover down.

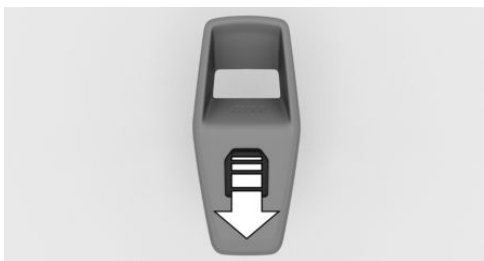

2. Fit optional accessories, see installation instructions.

Wireless charging tray

Principle

The wireless charging tray allows wireless charging of mobile phones and other mobile devices certified according to the Qi standard.

General

Depending on the mobile device, quick charging functions are supported.

The integrated fan allows cooling of the device being charged.

When inserting the device to be charged, make sure that there are no objects in the wireless charging tray together with the device to be charged.

(⚡) The charging process is indicated by the charge indicator on the control display.

Safety information

⚠ WARNING

When charging a Qi-compatible device in the wireless charging tray, any metal objects that are in the tray together with the device can become very hot. If storage media or electronic cards, for example, smart cards, cards with magnetic strips or cards for transmitting

signals, are located in the tray together with the device, their function may be impaired. There is a danger of injury or material damage. When charging mobile devices, make sure there are no objects in the tray together with the device.

Overview

Dock in the centre console:

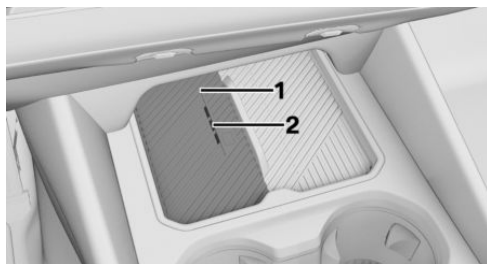

- 1 Dock surface
- 2 Fan

Operating requirements

- ▶ The device to be charged must have been certified according to the Qi standard.
- ▶ Standby state is switched on.
- ▶ Charging function is turned on.
- ▶ The mobile phone cannot exceed a maximum size of approx. 170 x 85 x 18 mm, 6.69 x 3.34 x 0.7 in.
- ▶ Protective sleeves and covers must be suitable for wireless charging.
- ▶ The mobile phone to be charged is located in the middle of the dock. The display of the mobile phone faces upwards.

Switching the charging function on/off

1.  Apps menu
2. "Vehicle"
3. "System settings"

4. "Wireless charging tray"
5. "Wireless charging"

Inserting the mobile phone

Place the mobile phone in the centre of the dock on the driver's side with the display facing upwards.

Forgotten phone warning

General

A warning can be issued if a mobile phone with Qi certification has been left in the wireless charging tray when exiting the vehicle.

The forgotten phone warning is shown in the instrument cluster.

Enabling/disabling the forgotten warning

1.  Apps menu
2. "Vehicle"
3. "System settings"
4. "Wireless charging tray"
5. "Mobile phone reminder"

System limits

The charging current may be reduced or charging may be temporarily interrupted in the wireless charging tray in the following situations:

- ▶ Due to excessive temperatures of the tray and mobile phone.
- ▶ When there are objects between the mobile phone and wireless charging tray.
- ▶ If storage media or electronic cards, such as chip cards, cards with magnetic strips or cards for signal transmission, are located between the mobile phone and the wireless charging tray.
- ▶ By protective sleeves and covers that exceed a thickness of 2 mm, 0.07 in.

- ▶ By protective sleeves and covers made of unsuitable material, e.g. with magnetic parts.
- ▶ By add-on parts on the mobile phone, e.g. holders.
- ▶ By settings on the mobile phone, for example for charging. Follow the relevant instructions on the control display and in the instructions for the mobile phone, if applicable.

Interior camera

Principle

The interior camera can be used to take media recordings of the vehicle interior.

General

The interior camera can enable the following functions:

- ▶ Interior camera.
Media can be recorded, stored and displayed.
- ▶ Remote Inside View.
The vehicle interior can be recorded using the My BMW App.
- ▶ Anti-theft recorder.
If the alarm system is triggered, the vehicle interior is automatically recorded. The media recording can be displayed via the My BMW App.

Data protection

General

The reliability of the recording and the use of media recordings depend on the legal regulations in the country where the system is to be used. The user is responsible for the use of the system and for complying with the provisions that apply in each case.

Before using for the first time, the vehicle manufacturer recommends checking that there are no legal or official restrictions on using the system in the state or country in question. Additionally, the legality of using the system should be checked at regular intervals, especially if the vehicle frequently crosses borders.

Other users and passengers of the vehicle must be informed about the system. Information about the system must also be provided if the vehicle is passed on to anyone else.

Data transfer and data storage

Data transfer and data storage of the media recordings depends on the recording function.

Interior camera:

- ▶ Data transfer to a mobile device, connection to the vehicle via Wi-Fi.
- ▶ Data is stored in the vehicle and is assigned to the BMW ID or a driver profile.

Remote Inside View:

- ▶ Data transfer with the My BMW App to a mobile device, connection with the ConnectedDrive account.
- ▶ Data storage takes place in the My BMW App and after the data transfer to the mobile device.

Anti-theft recorder:

- ▶ Data transfer with the My BMW App to a mobile device, connection with the ConnectedDrive account.
- ▶ Data is stored in the vehicle and after the data transfer to the mobile device.

More information on the scope and content of data processing is available on the Internet in the ConnectedDrive data protection notes / service descriptions.

Operating requirements

Interior camera:

- ▶ Privacy Policy has been accepted.

Data protection, see page 74.

- ▷ The camera is activated.

To send media recordings to mobile devices:

- ▷ Data transfer is activated.
- ▷ Mobile device is connected to the vehicle via Wi-Fi.

Remote Inside View/Anti-theft recorder:

- ▷ Privacy Policy has been accepted.
- ▷ My BMW App is installed on the mobile device.
- ▷ My BMW App is linked with the Connected-Drive account.
- ▷ The vehicle is locked and parked.
- ▷ Anti-theft recorder: equipped with alarm system.

Ensure that the faces of the passengers are visible and are not partially or completely covered, for example by face masks.

Overview

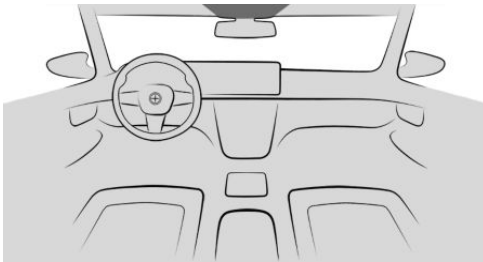

The interior camera is located on the headliner.

For further information:

Around the headliner, see page 41.

Activating/deactivating interior camera

Prior to the first use of the interior camera, the recording function and data transfer must be activated, if necessary. To do this, confirm the query on the control display.

Observe the applicable statutory regulations.

The recording function or data transfer can be deactivated and activated.

1.  Apps menu
2. "All apps"
3. "Interior camera"
4. "Settings"
5. Select the desired setting.

Interior camera

Recording mode

Recording mode	Function
"Single photo"	Shortly after triggering, a photo will be taken.
"Smile"	When the system detects a smile, a picture will be taken.
"Self-timer (3 sec.)"	After the timer has elapsed, a photo will be taken.
"Burst mode"	Shortly after triggering, a series of pictures will be taken.

Take picture

1.  Apps menu
2. "All apps"
3. "Interior camera"
4. "Photo"
5. Select desired recording mode.
6. Trigger photo capture.

Depending on the selected recording mode, a photo recording is made shortly after triggering, when a smile is recognised or after the timer has elapsed.

For burst shots, the series of pictures will be displayed as a preview.

Video recording

1. "MENU"
2. "All apps"
3. "Interior camera"
4. "Video"
5. Start video recording.

Video recording is time-limited.

Viewing and managing media recordings

Saved media recordings can be displayed, sent, and deleted in the vehicle.

In some national-market versions, media recordings on the control display are only displayed up to approx. 3 km/h, approx. 2 mph for your own safety.

1.  Apps menu
2. "All apps"
3. "Interior camera"
4. "Gallery"
5. Select the desired media recording.
6. Select the desired setting.

Scan the QR code shown on the display to send media recordings to a mobile device. The media recording is sent when the pop-up opens on the mobile device. The mobile device must be connected to the vehicle via Wi-Fi.

Settings

1.  Apps menu
2. "All apps"
3. "Interior camera"
4. "Settings"
5. Select the desired setting.

An individual gesture can be set up for media recording with the interior camera.

Remote Inside View

Media recordings of the vehicle interior can be displayed on a mobile device with the My BMW App in order to check the vehicle interior, for example, for forgotten objects.

This function is not suitable for monitoring persons or animals left in the vehicle.

Anti-theft recorder

If the alarm system is triggered, the vehicle interior is automatically recorded. The My BMW App provides a notification about the media recording. The media recording can be displayed on the mobile device.

Up to three media recordings are stored in the vehicle and synchronised with the My BMW App. The media recordings saved in the vehicle are deleted when the vehicle is reset to its factory settings.

Occupying the seats

The interior camera is also used for the detection of occupied seats.

When all doors are closed, the interior camera regularly turns on automatically. The system analyses the interior to detect occupied seats. No recordings are made. While the interior camera is active, two infrared light sources next to the camera lens light up. The infrared light sources can be visible depending on the light conditions.

Storage compartments

Vehicle equipment

This chapter describes equipment, systems and functions which are offered or may be offered in future on a model-specific basis, even if they are not included in the vehicle in question.

For further information:

Vehicle equipment, see page 8.

Safety information

WARNING

Devices connected to the vehicle with a cable, e.g. mobile phones, or loose objects can be thrown around the interior while driving, e.g. in the event of an accident, or when braking or performing evasive manoeuvres. There is a danger of injury or material damage. Secure devices connected to the vehicle with a cable or loose objects.

WARNING

Open storage compartment lids, e.g., for the glove compartment or centre armrest, protrude into the interior and can interfere with the deployment of airbags. In addition, objects inside the open storage compartment may be thrown into the interior while driving, e.g., in the event of an accident or when braking or avoiding an obstacle. There is a danger of injury. Immediately close storage compartments after use.

WARNING

Anti-slip mats can damage the instrument panel. Attached objects can become detached. There is a danger of injury or material damage. Do not use anti-slip mats.

Glove compartment

Opening the glove compartment

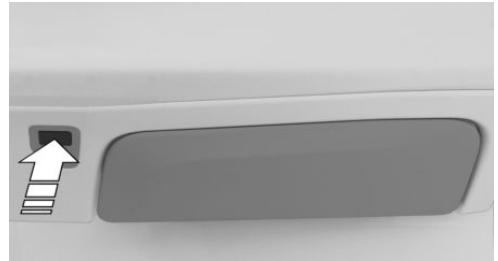

Press the key.

Storage compartments in the doors

General

There are storage compartments in the doors.

Safety information

WARNING

Breakable objects, for example glass bottles or glasses, may get broken in the event of an accident or when braking or taking avoidance manoeuvre. Splinters may scatter throughout the interior. There is a danger of injury or material damage. Do not use breakable objects

during a journey. Only stow breakable objects in closed storage compartments.

Storage compartments in the centre console

There are storage compartments in the centre console.

For further information:

Wireless charging tray, see page [310](#).

Front centre armrest

General

There are storage compartments in the centre armrest between the seats.

Opening the centre armrest

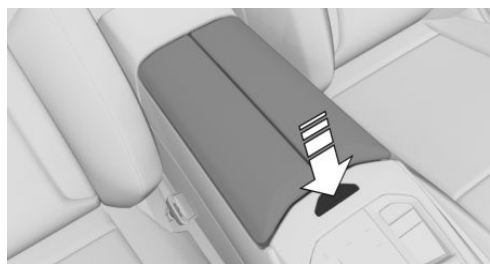

Press the key.

Close the centre armrest

Press both lids down until they engage.

Cup holder front

Safety information

WARNING

Unsuitable containers placed in the cup holders may damage the cup holders or be flung into the interior, for example in the event of an accident or when braking or taking avoidance manoeuvre. Spilled fluids can distract the driver from the traffic situation, lead to an accident and damage vehicle components. Hot beverages may damage the cup holders or cause scalding. There is a danger of injury or material damage. Do not force objects into the cup holder. Use lightweight, sealable and shatterproof containers. Clean up spilled fluids immediately. Do not transport hot drinks.

Overview



There are two cup holders in the centre console.

Cup holder rear

Safety information

WARNING

Unsuitable containers placed in the cup holders may damage the cup holders or be flung into the interior, for example in the event of an accident or when braking or taking avoidance manoeuvre. Spilled fluids can distract the driver from the traffic situation, lead to an accident and damage vehicle components. Hot beverages may damage the cup holders or cause scalding. There is a danger of injury or material damage. Do not force objects into the cup holder. Use lightweight, sealable and shatterproof containers. Clean up spilled fluids immediately. Do not transport hot drinks.

Overview



There are two cup holders in the centre armrest.

Coat hooks

General

The coat hooks are located on the grab handles in the rear.

Safety information

WARNING

Items of clothing on the coat hooks can impair visibility when driving. There is a risk of accident. Hang items of clothing from the coat hooks in such a way that they do not obstruct visibility when driving.

WARNING

Incorrect use of the coat hooks can present a danger, for example if objects are thrown around as a result of braking or avoidance manoeuvres. There is a danger of injury or material damage. Only hang lightweight objects, for example items of clothing, on the coat hooks.

Luggage compartment

Vehicle equipment

This chapter describes equipment, systems and functions which are offered or may be offered in future on a model-specific basis, even if they are not included in the vehicle in question.

For further information:

Vehicle equipment, see page 8.

Loading

Safety information

WARNING

A high total weight can make the tyres overheat, causing internal damage and a sudden tyre pressure loss. Handling characteristics may be adversely affected, for example reduced directional stability, longer stopping distance and altered steering characteristics. There is a risk of accident. Please comply with the permitted load index of the tyre, and do not exceed the permitted total weight.

WARNING

If the permitted total weight and the permitted axle loads are exceeded, the operational safety of the vehicle is no longer guaranteed. There is a risk of accident. Do not exceed the permitted total weight and permitted axle loads.

WARNING

Devices connected to the vehicle with a cable, e.g. mobile phones, or loose objects can be thrown around the interior while driving, e.g. in the event of an accident, or when braking or performing evasive manoeuvres. There is a danger of injury or material damage. Secure devices connected to the vehicle with a cable or loose objects.

WARNING

Incorrectly stowed objects may slip or be thrown into the interior, for example in the event of an accident or when braking or taking avoidance manoeuvre. Vehicle occupants could be struck and injured. There is a danger of injury or material damage. Stow and secure objects and the load correctly.

NOTICE

Liquids in the luggage compartment may cause damage. There is a risk of material damage. Ensure that no liquids leak out into the luggage compartment.

Stowing and securing loads in the vehicle

- ▷ Wrap protective material around any sharp corners and edges on the load.
- ▷ Secure load-securing equipment to the lashing eyes in the luggage compartment.
- ▷ Small and lightweight load: secure with tensioning straps or retaining straps or with a luggage compartment net.
- ▷ Large and heavy loads: secure with lashing straps.

- ▶ Heavy loads: stow as far forward as possible, low down and directly behind the rear seat backrests.
- ▶ Very heavy loads: stow as far forward as possible, low down and directly behind the rear seat backrests. If there are no passengers on the rear seat, insert both outer seat belts into the respective opposite buckles.

Lashing eyes in the luggage compartment

General

Load-securing equipment, for example lashing straps, tensioning straps, retaining straps or luggage compartment nets, must be secured to the lashing eyes.

Overview



The lashing eyes are located in the luggage compartment.

Multifunction hook

General

There is a multifunction hook on the left and right side in the luggage compartment.

Safety information

WARNING

Incorrect use of the multifunction hook may present a danger, for example if objects are flung around when performing braking and avoidance manoeuvres. There is a danger of injury or material damage. Only hang light-weight objects from the multifunction hooks. Only transport heavy luggage in the luggage compartment if suitably secured.

Weight

Only hang items with a maximum weight of 5 kg, approx. 11 lb on the multifunction hook.

Side storage compartment, right

Depending on the equipment:

There is a storage compartment on the right side of the luggage compartment.

Side storage compartment, left

Depending on the equipment:

There is a storage compartment on the left side of the luggage compartment.

For emergency spare wheel: enlarging the luggage compartment

Principle

The emergency spare wheel and associated components can be removed temporarily to increase the luggage compartment space.

Taking out the emergency spare wheel and storage elements

1. To remove the luggage compartment floor, pull it up directly behind the rear seat backrests, or fold down the rear seat backrest, see page 320, if necessary.

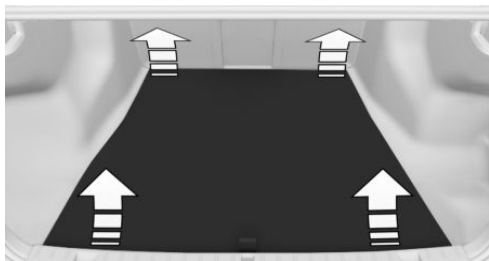

2. Remove the storage compartment.

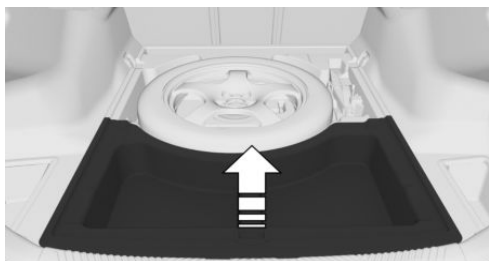

3. Slightly lift the storage tray containing the wheel change set and emergency spare wheel, then pull it backwards.

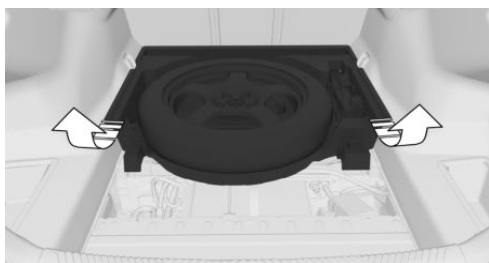

4. Remove the emergency spare wheel, wheel change set, and storage tray.
5. Insert the luggage compartment floor.

Inserting the emergency spare wheel and storage elements

Proceed in reverse order to insert the emergency spare wheel and storage elements.

Enlarging the luggage compartment

Principle

The luggage compartment can be enlarged by folding down the rear seat backrests.

General

The rear seat backrest is split 40–20–40. The right rear seat backrest and the centre section can be folded down individually. The left rear seat backrest can be folded down together with the centre section.

The rear seat backrests can be folded down from the luggage compartment. The centre section can be folded down separately from the rear.

Safety information

WARNING

When folding down the rear seat backrest, vehicle parts can be damaged or body parts can become trapped. There is a danger of injury or material damage. When folding down, make sure that the movement range of the rear seat backrest, including the head restraint, is kept clear.

WARNING

If a rear seat backrest is not locked, unsecured load may be flung into the interior, for example in the event of an accident or when braking or taking avoidance manoeuvre. There is a danger of injury. Make sure

that the rear seat backrest is locked after it has been folded back.

WARNING

If the seat is not set properly or the child seat has been installed incorrectly, the child restraint system may have restricted or no stability at all. There is a danger of injury or danger to life. Make sure that the child restraint system rests firmly against the seat backrest. Wherever possible, adapt the backrest angle of all relevant seat backrests and adjust the seats correctly. Make sure that the seats and their backrests are correctly engaged or locked. If possible and if necessary, adjust the height of the head restraints or remove them.

Folding down the rear seat backrest

From the luggage compartment

1. Unlock the belt lock of the centre seat belt in the rear passenger compartment with the seat belt tongue of another seat belt.
2. Insert the seat belt tongue at the end of the seat belt into the designated mounting on the parcel shelf.

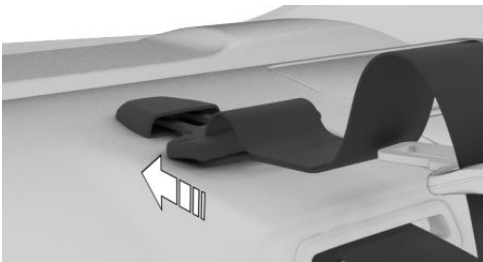

3. Push the respective head restraint as far down as possible.
4. Pull the corresponding lever in the luggage compartment to unlock the rear seat

backrest. The unlocked rear seat backrest moves slightly to the front.

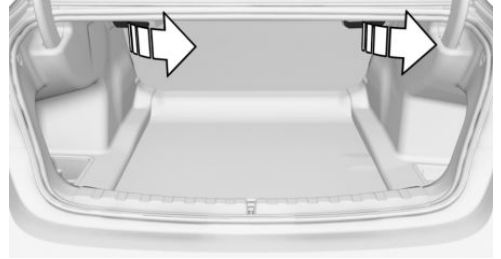

5. Fold the rear seat backrest forward.



Folding back the rear seat backrest

1. Fold back the rear seat backrest into the seat position and engage.
2. Remove seat belt tongue from the mount on the parcel shelf.
3. Put seat belt tongue into the belt lock of the centre safety belt. The seat belt tongue must be heard to engage.

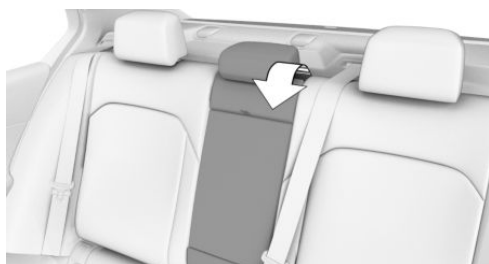

Folding down the centre section



Pull the lever and fold the centre section forwards.

Locking/unlocking the centre section

The centre section can be locked to prevent it from folding out of the rear, for example if the vehicle is to be handed over to valet parking.

1. Fold down the left rear seat backrest with the centre section.
2.  Lock: push the locking mechanism forwards.
 -  Unlock: push the locking mechanism backwards.



3. Fold back the rear seat backrest into the seat position and engage.

Driving precautions

Vehicle equipment

This chapter describes equipment, systems and functions which are offered or may be offered in future on a model-specific basis, even if they are not included in the vehicle in question.

For further information:

Vehicle equipment, see page 8.

Running-in instructions

General

Moving parts need to adjust to each other.

The following notes will help to maximise the vehicle's lifetime and efficiency.

Safety information

 **WARNING**

New parts and components can cause safety and driver assistance systems to respond with a delay. There is a risk of accident. After new parts have been installed or if the vehicle is new, drive moderately and take action promptly if necessary. Please comply with running-in procedures for the corresponding parts and components.

Engine, transmission and differential

Up to 2000 km, 1200 miles

Do not exceed the maximum rotational speed and vehicle speed:

- ▶ With petrol engine 4500 rpm and 160 km/h, approx. 100 mph.
- ▶ With diesel engine 3500 rpm and 150 km/h, approx. 93 mph.

Generally avoid kickdown and driving under full load.

From 2000 km, 1200 miles onwards

Rotational speed and vehicle speed can be gradually increased.

Tyres

Due to the manufacturing process, new tyres do not achieve their full road grip immediately.

Drive moderately for the first 300 km, 200 miles.

Brake system

Brake discs and brake pads must be run in to avoid effects that can lead to brake noise. Drive moderately for the first 500 km, approx. 300 miles.

After fitting new parts

Please comply with the running-in procedures again if the components previously referred to are renewed.

General driving notes

Closing the boot lid

Safety information

WARNING

When open, the boot lid protrudes above the vehicle, and in the event of an accident, braking or avoidance manoeuvre, it can endanger vehicle occupants and other road users, or damage the vehicle. In addition, exhaust fumes or water may enter into the vehicle interior. There is a danger of injury or material damage. Do not drive with the boot lid open.

Driving with the boot lid open

If the vehicle still needs to be driven with the boot lid open:

- ▷ Close all windows.
- ▷ Adjust the blower output to a high setting.
- ▷ Maintain a moderate speed.
- ▷ Secure the boot lid, e.g. with a tensioning belt.

Hot exhaust system

WARNING

High temperatures may occur under the vehicle body during driving, for example because of the exhaust system. Contact with the exhaust system may cause burns. There is a danger of injury. Do not touch the exhaust system, including exhaust pipe, when hot.

WARNING

If flammable materials, for example leaves or grass, come into contact with hot parts of the exhaust system, these materials can catch fire. There is a risk of fire and injury. Never

remove the heat shields installed in this area or apply underbody protection to them. Make sure that when driving, idling or parking, no flammable materials can come into contact with hot vehicle parts.

Exhaust gas particulate filter

Principle

The exhaust gas particulate filter traps soot particles. The soot particles are burned at high temperatures to clean the exhaust gas particulate filter as when required.

General

The cleaning process takes a few minutes, during which the following may occur:

- ▷ The engine may temporarily run a little roughly.
- ▷ A slightly higher rotational speed may be required to achieve the usual power output.
- ▷ Fuel consumption may increase. The increased fuel consumption is shown as the mean value in the current consumption display.
- ▷ There may be a small amount of smoke from the exhaust system, even after stopping the engine.
- ▷ Noise, for example from radiator fan operation, may be heard, even some minutes after stopping the engine.

It is normal for the radiator fan to keep running for several minutes, even after short journeys.

Condensation detected in the drive system

The proper function of the drive is ensured by various driver profiles. Consistently driving at low load can impair this function (e.g., condensation may form in the drive system). Occasionally longer engine running times with higher loads can counteract this.

Proceed as follows the next time you drive outside of built-up areas for around 30 minutes.

With petrol engine:

- ▶ Deactivate the Cruise Control System.
- ▶ Activate the Sport programme.
- ▶ If possible, drive at alternating speeds.

With diesel engine:

- ▶ Activate the Sport programme.
- ▶ If possible, drive at a constant speed.

For further information:

Steptronic transmission, see page 136.

Attachment point of wireless systems

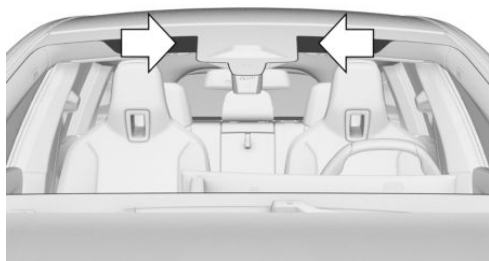

With climate comfort windscreen: the marked area does not have a heat-reflecting coating. The marked area can be used to attach wireless systems, e.g.:

Vehicle laminated glass

The laminated glass offers full protection against the harmful effects of UV light on the skin.

Radio signals

! WARNING

Certain vehicle functions may be affected by interference from high-frequency radio signals. Such signals are output from a series of transmission systems, for example from

air traffic beacons or relay stations for mobile telecommunications.

We recommend you consult your Service Partner should you experience any difficulties.

Mobile radio in the vehicle

! WARNING

There is a possibility of reciprocal interference between the vehicle electronics and mobile radio devices. Radiation is generated when mobile radio devices are transmitting. There is a danger of injury or material damage. If possible, only use mobile radio devices, for example mobile phones, inside the vehicle if they are connected directly to an external aerial or personal eSIM in order to eliminate reciprocal interference and to divert the radiation away from the vehicle interior.

Aquaplaning

On wet or slushy roads, a water wedge can form between the tyres and the road.

This phenomenon is known as aquaplaning and can cause the tyre to lose contact partially or fully with the road surface, meaning that the vehicle can neither be steered, nor the brakes properly applied.

Driving through water

General

Please comply with the following when driving through water:

- ▶ Only drive through when the combustion engine is running.
- ▶ Prevent the engine from switching off, e.g., by deactivating Auto Start/Stop.
- ▶ Only drive through still water.

- ▷ Only drive through water up to a max. depth of 25 cm, 9.8 in.
- ▷ Drive through water at a walking speed of no more than 5 km/h, 3 mph.

Safety information

NOTICE

Driving too quickly through excessively deep water can cause water to enter the engine compartment, electrical system or transmission. There is a risk of material damage. When driving through water, do not exceed the maximum water depth and maximum speed specified above.

Safe braking

General

The vehicle is equipped with an Anti-lock Braking System as standard.

Perform full braking in situations that require it. In order to achieve the best possible braking force assistance, do not reduce the pressure on the brake pedal during full braking.

The vehicle remains steerable. Steer as smoothly as possible to avoid any obstacles.

Objects in the movement range of the pedals

WARNING

Objects in the driver's footwell can restrict the pedal travel or block a pedal that has been pressed. There is a risk of accident. Ensure that items in the vehicle are stowed securely and cannot get into the driver's footwell. Only use floor mats that are suitable for the vehicle and can be securely fastened to the floor. Do not use loose floor mats, and do not place several floor mats on top of one another. Make sure that there is sufficient space

for the pedals. Ensure that floor mats are securely reattached after removal, for example for cleaning.

Pedal feel when driving off

When drive-ready state is switched on from rest state, an unfamiliar pedal feel can occur, for example short or long pedal travel. Once you have completely released the brake pedal, the pedal feel will be back to normal.

Wet roads

In wet weather, road salt exposure and in heavy rain, apply the brakes lightly every few kilometres/miles.

Ensure that you do not obstruct other road users when doing so.

The heat generated by braking dries the brake discs and brake pads and protects them against corrosion.

This helps to maintain braking power so that it is available immediately when needed.

Downhill gradient

General

When driving on long or steep downhill stretches, use the gear in which the least braking is required. Otherwise the brake system can overheat and the braking effect is reduced.

Engine braking effect can be additionally increased by manually shifting down, even into first gear where required.

Safety information

WARNING

Even slight but continuous pressure on the brake pedal can cause overheating, brake wear or even brake system failure. There is a risk of accident. Avoid excessive loads on the brake.

WARNING

In idle or with drive-ready state switched off, safety-relevant functions, for example engine braking effect or steering and braking force assistance, are either restricted or not available at all. There is a risk of accident. Do not drive in idle or with the drive-ready state switched off.

Corrosion of the brake disc

Corrosion of the brake discs and contamination of the brake pads increase in the following circumstances:

- ▶ Low mileage.
- ▶ Extended stationary periods when the vehicle is not used.
- ▶ Infrequent use of the brakes.
- ▶ Aggressive, acidic or alkaline cleaning agents.

During braking, corroded brake discs may cause juddering which usually cannot be eliminated.

Condensation when vehicle is parked

When the automatic air conditioning is operating, condensation develops and exits underneath the vehicle.

Pennant holder

Safety information

NOTICE

When a pennant is attached, damage can be caused to the vehicle, to the pennant holder and to the pennant itself at high speeds. There is a risk of material damage. Do not exceed a speed of 130 km/h, 80 mph. Re-

move the pennant before driving at high speeds.

Overview



The pennant holder is located on the side of the vehicle.

Fitting

1. Remove the protective cap.
2. Insert the pennant horizontally.
3. Rotate the pennant through 90° clockwise to lock the pennant in place.

Roof bars

General

Roof racks are available as optional accessories.

Safety information

WARNING

When driving with a roof load, for example with roof bars, the higher centre of gravity can mean that driving safety is no longer guaranteed in critical driving situations. There is a risk of accident or material damage. Driving with roof load only with activated Dynamic Stability Control.

Roof strip with flaps

The mounting points are located on the roof strip above the doors.

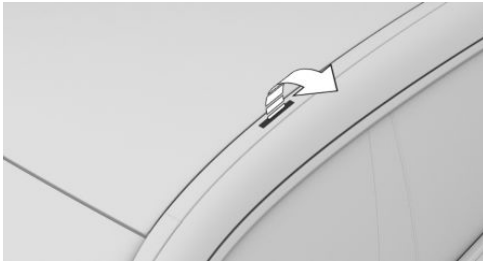

Fold the cover outwards.

Fitting

Follow the installation instructions for the roof rack.

Loading

Loaded roof bars change the driving and steering behaviour of the vehicle by shifting the centre of gravity.

When loading and driving, bear the following in mind:

- ▶ Do not exceed the permitted roof and axle load or the permitted total weight.
- ▶ Distribute the roof load evenly.
- ▶ The roof load must not be spread over an area that is too large.
- ▶ Place heavy items of luggage at the bottom.
- ▶ Securely fasten the luggage, for example with tensioning straps.
- ▶ Do not allow objects to protrude into the swing range of the boot lid.
- ▶ Driving behaviour. Avoid driving off and braking suddenly and fast cornering.

Driving on a racing track

WARNING

The vehicle is not designed for use in M Sport competitions or similar. There is a risk of accident. Do not use the vehicle in M Sport competitions or similar.

The higher mechanical and thermal loads involved when driving on racing tracks lead to increased wear. This wear is not covered by the warranty.

Before and after driving on a racing track, have the vehicle checked at an authorised Service Partner or another qualified Service Partner or a specialist workshop.

Trailer and rear carrier

Vehicle equipment

This chapter describes equipment, systems and functions which are offered or may be offered in future on a model-specific basis, even if they are not included in the vehicle in question.

For further information:

Vehicle equipment, see page 8.

General

The permitted trailer loads, axle loads, trailer nose weights and permitted total weight rating are specified in the technical data.

Consult an authorised Service Partner or another qualified Service Partner or a specialist workshop about options for increasing the loads.

For Australia: note

Towing

The Australian/New Zealand Standards AS 4177.1-2004 Caravan and light trailer towing components – trailer tow hitches and towing brackets includes the following statement which BMW Group Australia herewith adopts: **FOR TRAILER TOWING ONLY.** The trailer tow hitch supplied with your BMW vehicle should only be used for towing purposes, the trailer tow hitch assembly should not be used in conjunction with any towbar-mounted carrying device, such as, for example, a bicycle carrier.

As all BMW Group towbar assemblies are designed, tested and approved as a single unit, the practice of modifying or replacing the BMW supplied towball mount assembly is not ap-

proved. Use only the genuine BMW towball mount assembly.

BMW Group Australia does not recommend or support the installation and use of a Weight Distribution Hitch or Load Levelling Device on any BMW Group vehicle. The use of such devices may affect the vehicle's warranty status.

We recommend you consult your Authorised BMW Dealer for any further advice or clarification.

Before a journey

Trailer nose weight

The trailer nose weight should not be less than the minimum trailer nose weight of 25 kg, 55 lb. Utilise the maximum trailer nose weight as far as possible.

The weight of the trailer tow hitch and the trailer nose weight reduce the maximum load of the towing vehicle. The trailer nose weight increases the vehicle weight. Do not exceed the permitted total weight of the towing vehicle.

Loading

Distribute the load as evenly as possible over the loading area.

Stow the load as low down as possible and as close as possible to the trailer axle. A low centre of trailer gravity makes the car/trailer combination much more stable and safe to drive.

The permitted total weight of the trailer and the permitted trailer load of the vehicle must not be exceeded. The lower value is the limit which should be adhered to.

Tyre inflation pressure

Check the vehicle's and the trailer's tyre inflation pressures carefully.

On the vehicle, the tyre inflation pressure for higher loads applies.

For the trailer, the regulations of the manufacturer apply.

Re-initialise the flat tyre monitor or reset the Tyre Pressure Monitor or after the tyre inflation pressure has been corrected or a trailer has been attached or detached.

For further information:

- ▷ Tyre inflation pressure information, see page 348.
- ▷ Tyre Pressure Monitor, see page 358.
- ▷ Flat Tyre Monitor, see page 364.

Exterior mirrors

Two exterior mirrors which bring both rear corners of the trailer into your field of view are required by law. Mirrors of this type are available as optional accessories from an authorised Service Partner or another qualified Service Partner or a specialist workshop.

Power consumption

General

Before the start of a journey, check the function of the trailer rear lights.

When towing a caravan, only operate power consumers briefly to avoid placing an excessive load on the vehicle battery.

Not Australia/New Zealand:Trailer rear lights

The power output of the trailer's rear lights must not exceed the following values:

- ▷ Turn indicators: 42 watts per side.
- ▷ Rear lights: 50 watts per side.
- ▷ Brake lights: 84 watts total.

- ▷ Rear fog lights: 42 watts total.
- ▷ Reversing lights: 42 watts total.

Australia/New Zealand:Trailer rear lights

The power output of the trailer's rear lights must not exceed the following values:

- ▷ Turn indicators: 54 watts per side.
- ▷ Brake lights: 108 watts total.
- ▷ Rear lights: 100 watts in total.
- ▷ Reversing lights: 54 watts total.

Not for Australia:Trailer tow hitch with electrically adjustable ball head

General

The adjustable ball head is located on the underside of the vehicle.

Safety information

WARNING

If the ball head is not locked, unstable driving conditions or accidents can result. There is a risk of accident or material damage. Before a journey with a trailer or rear carrier, check that the ball head is correctly locked.

NOTICE

The trailer tow hitch is intended to be used with a trailer. If the ball head of the trailer tow hitch has been swivelled out, it may become jammed if the vehicle is subsequently driven without a trailer or rear carrier. There is a risk of material damage. Swivel the ball head back in when driving without a trailer or rear carrier.

Overview



The button for swivelling the ball head in and out is in the luggage compartment.

Operating requirements

- ▶ Vehicle is standing on level ground.
- ▶ Luggage compartment is open.
- ▶ The trailer socket is not occupied.
- ▶ Trailer operation is not activated.
- ▶ The vehicle battery is sufficiently charged.

The LED in the button illuminates green if the system is operational.

Swivelling out the ball head

1. Open the luggage compartment.
2. Step out of the swing range of the ball head behind the vehicle.

3.  Press the button in the luggage compartment.
The ball head swivels out. The LED flashes green.

4. Wait until the ball head has reached the end position and audibly locks.

If the ball head is not properly locked, the LED in the button lights up red.

Swivelling the ball head back in

1. Disconnect the trailer or rear carrier.
2. Remove any fittings for the track-stabilising devices.

3. Remove the power supply connector for the trailer and any adapter from the trailer socket.

4.  Press the button in the luggage compartment.

The ball head swivels inwards. The LED flashes green.

5. Wait until the ball head has reached the end position.

Cancelling the swivel operation

General

The swivel movement is interrupted, might be reversed or is not performed if electrical current limits are exceeded, for example at very low temperatures, or if mechanical resistance is encountered. LED illuminates red.

Repeating the swivel operation

1. Switch on drive-ready state.
2. Step out of the swing range of the ball head behind the vehicle.

3.  Press the button in the luggage compartment and hold it until the ball head has moved completely in or out.

If necessary, repeat the swivel movement with the button pressed and the engine running.

The LED in the button illuminates green when the ball head has reached an end position.

If the swivel movement is repeatedly interrupted, contact an authorised Service Partner or another qualified Service Partner or a specialist workshop.

Trailer socket

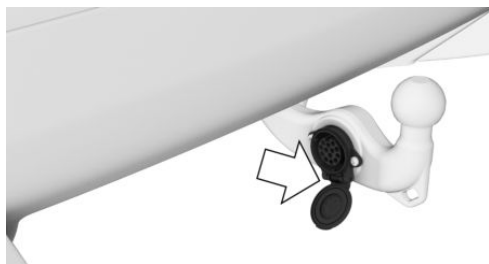

The trailer socket is located on the trailer tow hitch.

Fold down the cover.

Eye for trailer securing cable

General

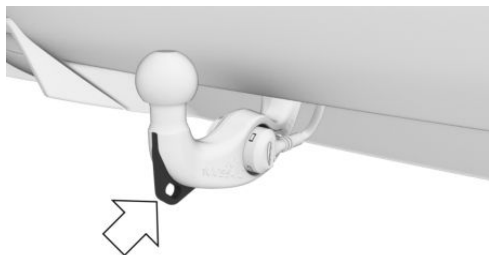

There is an eye on the trailer tow hitch for fastening the trailer securing cable.

Safety information

⚠ WARNING

If the trailer's securing cable or securing chain is not attached correctly, the trailer may come detached unintentionally. There is a risk of accident. Before driving with a trailer, make sure that the trailer's securing cable or securing chain is correctly attached to the eye of the trailer tow hitch.

⚠ WARNING

If the trailer's securing cable or securing chain is not attached correctly, the securing cable or securing chain may become entangled and damage the vehicle or trailer. There is a risk of accident. Before driving with a trailer, make sure that the trailer's securing cable or securing chain is correctly attached to the eye of the trailer tow hitch. Make sure that the securing cable or securing chain has the necessary clearance and is not dragging on the ground.

Driving with a trailer or rear carrier

General

When driving with a trailer or rear carrier, some driver assistance systems are unavailable or only available to a limited extent. A Check Control message is shown where applicable. The driving stability control systems, e.g., Anti-lock Braking System, can still be used.

If necessary, select another driver assistance system that can be used in trailer operation, e.g., Active Cruise Control.

For further information:

- ▶ Driver assistance systems, see page [227](#).
- ▶ Driving stability control systems, see page [223](#).
- ▶ Cruise Control, see page [235](#).

Safety information

⚠ WARNING

Speeds in excess of approximately 80 km/h, 50 mph, can be enough to cause trailer snaking, depending on the type of trailer and the load being carried. There is a risk of accident or material damage.

Keep to an appropriate speed when towing a trailer. If the trailer starts to snake, brake immediately and make the necessary steering corrections as carefully as possible.

 **WARNING**

The tyre inflation pressure must be adapted because of the increased axle load in trailer operation. Driving with inadequate tyre inflation pressure can damage the tyres. There is a risk of accident or material damage. Do not exceed a speed of 100 km/h, 60 mph. Increase the tyre inflation pressure of the towing vehicle by 0.2 bar. Note the maximum possible tyre inflation pressure stated on the tyre.

Operation with trailer or rear carrier

General

If the trailer socket is occupied, a selection menu is displayed on the control display. In the selection menu, specify whether the vehicle is to be driven with a trailer or rear carrier.

When driving with a trailer or rear carrier, for example rear bicycle carrier, and if the trailer socket is not occupied, some driver assistance systems may only operate to a limited extent or may malfunction. To avoid malfunctions, activate the operation of the trailer or rear carrier manually.

Safety information

 **WARNING**

If incorrect settings are made on the control display, some driver assistance system functions may be restricted or faulty. There is a risk of accident. Ensure that the relevant setting is activated when operating with a trailer or rear carrier.

Activating/deactivating trailer operation manually

1.  Apps menu
2. "Vehicle"
3. "Driving settings"
4. "Driver assistance"
5. "Trailer mode"
6. "Type"
7. Select whether driving with or without trailer/rear carrier.

Maximum speed

General

When towing a trailer, the maximum permitted speed for the vehicle combination can be set. Depending on the equipment, this setting is taken into account for the speed limit systems.

For further information:

- ▷ Speed Limit Info, see page [227](#).
- ▷ Speed Limit Assist, see page [253](#).

Setting the maximum speed

1.  Apps menu
2. "Vehicle"
3. "Driving settings"
4. "Driver assistance"
5. "Trailer mode"
6. "Maximum permitted speed"
7. Select the required speed.

Upward gradients

General

Trailer operation is permitted for gradients of up to 12%.

If higher trailer loads have been subsequently approved, the limit is 8%.

Driving off on upward gradients

The parking brake is automatically released when the accelerator pedal is operated.

To prevent the vehicle from rolling back when driving off, use the parking brake.

-  Press and release the button shortly before starting.
The parking brake is engaged.
- To drive off, press the accelerator pedal with sufficient force.

Downhill gradient

On downward gradients, a car/trailer combination tends to start snaking movement earlier.

Before the downhill gradient, shift down manually to the next-lowest gear and drive downhill slowly.

High loads and high outside temperature

NOTICE

On long journeys with high trailer loads, a high outside temperature and a low fuel tank capacity, the fuel system can overheat leading to reduced engine output. There is a risk of material damage. Refuel in good time. On long journeys with high trailer loads and a high outside temperature, make sure that the fuel tank is more than 1/4 full.

Trailer Assistant

Principle

The Trailer Assistant provides support when reversing with a trailer.

When reversing, the steering angle of the front wheels is determined based on the articulation angle entered and then applied by the system.

Vehicle equipment

This system may not be available in the vehicle in question, for example due to the selected optional equipment, the national-market version or the possibility of subsequent enabling and software updates. This also applies to the individual functions of the system.

For further information:

Vehicle equipment, see page 8.

General

The kink angle determines the angle between the vehicle and trailer and thus the desired direction of travel of the car/trailer combination in reverse.

With the Trailer Assistant, the car/trailer combination is not guided via the steering wheel when reversing, but via the continuous input and correction of the kink angle on the control display.

The system takes control of the steering. The speed must be controlled by the driver using the accelerator pedal and the brake.

Follow the information in the Chapter "Parking assistance systems".

For further information:

Parking assistance systems, see page 260.

Safety information

WARNING

The system does not relieve you of your personal responsibility to assess the traffic situation correctly. Due to system limits, it cannot respond independently and appropriately in all traffic situations. There is a risk of accident. Adapt your driving style to the traffic conditions. Observe the traffic situation, be ready to take over steering and braking at any time, and actively intervene if the situation warrants it.

 **WARNING**

The system can steer the vehicle over or onto kerbs. There is a danger of injury or material damage. Observe the traffic situation and intervene actively if the situation warrants it

Operating requirements

- ▶ A trailer is attached and connected.
- ▶ The system has been configured for the trailer used.
- ▶ Trailer operation is activated, depending on vehicle equipment and national-market version.
- ▶ The Reversing Assist Camera is clean and unobstructed.
- ▶ Vehicles with removable trailer tow hitch: use suitable accessories approved by BMW.

Adapting the Trailer Assistant

The Trailer Assistant must be adapted again each time a trailer is hitched up.

A message on the control display prompts the driver to drive forwards at a low speed and steer while doing so.

Switching operating tips on/off

Operating tips can be displayed for easier operation of the Trailer Assistant.

1. Select the BMW ID or driver profile.
2.  Apps menu
3. "Vehicle"
4. "Driving settings"
5. "Driver assistance"
6. "Parking"
7. "Operating tips for Trailer Assistant"

Reversing with Trailer Assistant

1. Attach trailer to vehicle and connect.
2. Adapt the Trailer Assistant.
3. Depending on the equipment and national-market version, activate the trailer operation on the control display.



4.  With the vehicle at a standstill, press the button or engage reverse gear.

The parking assistance system display is shown on the control display.

5. "Start Trailer Assistant"
The control display shows the Reversing Assist Camera image with a view of the trailer towbar and a stylised display of the vehicle with the trailer.
6. If necessary, confirm or switch off the operating tips on the control display.
7. If necessary, engage reverse gear.
8. Set the desired kink angle.
Follow the instructions on the control display.
9. Take your hands off the steering wheel and carefully drive in reverse with the accelerator pedal and the brake.
 Green: the system takes control of the steering.
When driving in reverse, observe the vehicle surroundings.
If there are obstacles, stop immediately and take control of the steering.
10. If necessary, adjust the kink angle during driving to correct the direction.
11. Engage selector lever position P at the end of the manoeuvring process.

Cancelling Trailer Assistant manually

The manoeuvring of the car/trailer combination can be cancelled manually:

"Cancel"

Automatically cancelling Trailer Assistant

The system automatically cancels in situations such as the following:

- ▷ If the driver grips the steering wheel or steers the vehicle.
- ▷ When shifting from reverse gear to selector lever position D, the Trailer Assistant switches to standby mode.
If reverse gear is engaged again after a short distance, the function is reactivated.
- ▷ During activation or intervention by driver assistance systems.
- ▷ When the display on the control display is faded due to messages.
- ▷ In case of a slippery surface.
- ▷ When the vehicle is rolling, for example on a slope.
- ▷ In case of changed environmental factors.
- ▷ At speeds over approximately 10 km/h, 6 mph.

Turning trailer protection brake on/off

Whenever the Trailer Assistant is cancelled, trailer protection braking is performed and the vehicle is secured at a standstill. As a result, the car/trailer combination cannot continue to roll uncontrolled. The trailer protection braking function can be switched on/off.

1.  Apps menu
2. "Vehicle"
3. "Driving settings"
4. "Driver assistance"
5. "Parking"
6. "Trailer protection braking"

System limits

General

The maximum speed is limited to approx. 10 km/h, approx. 6 mph.

A warning occurs at a speed of approx. 7 km/h, approx. 4 mph.

If the maximum speed is exceeded, the function will be cancelled.

Functional limitations

The following can restrict the function during manoeuvring or lead to a collision:

- ▷ Accessories on the trailer towbar, for example rear bicycle carrier.
- ▷ Special shapes of trailer towbar and trailer.
- ▷ Unsuitable, detachable trailer tow hitches.
- ▷ Rear-view camera dirty or covered.

For further information:

Cameras, see page 42.

Trailers with pivot steering are not supported.

Trailer Stability Control

Principle

Trailer Stability Control assists in intercepting trailer snaking movements.

The system detects snaking movements and promptly brakes the vehicle so that the vehicle speed falls to below the critical speed range and the outfit is stabilised.

General

The system can also activate in extreme driving situations when the trailer socket is occupied without a trailer attached, for example when using a rear bicycle carrier with lighting.

Operating requirements

- ▶ A trailer is attached.
- ▶ The trailer socket is occupied.
- ▶ Vehicle speed is greater than approx. 65 km/h, approx. 40 mph.

System limits

The system is unable to intervene or intervenes too late, in the following situations for example:

- ▶ If a trailer folds instantly, for example on slippery or loose road surfaces.
- ▶ If a trailer with a high centre of gravity tips over before snaking movement is detected.
- ▶ If Dynamic Stability Control is deactivated or has failed.
- ▶ If the power consumption of a trailer is too low to be detected by the system, for example due to LED rear lights.

Rear carrier

Principle

The ball head of the trailer tow hitch can be used as a mount for rear carriers, for example rear bicycle carrier systems.

General

Rear carriers that have been classified as suitable by the vehicle manufacturer are available as optional accessories.

Rear bicycle carrier systems for up to three bicycles can be used.

Fitting

Follow the installation instructions for the rear carrier.

Loading

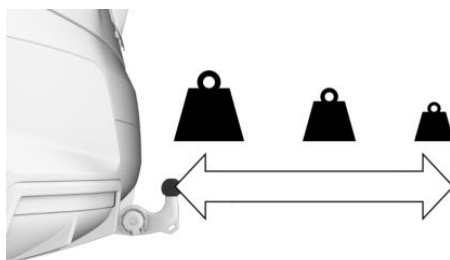

The permitted total weight of the rear carrier when loaded depends on how far its centre of gravity is from the ball head.

- ▶ If the centre of gravity is up to 30 cm, approx. 11.8 in away from the ball head, the total weight of the rear carrier must not exceed 75 kg, 165 lbs.
- ▶ If the centre of gravity is 60 cm, approx. 23.5 in from the ball head, the total weight of the rear carrier must not exceed 35 kg, 77 lbs.
- ▶ Stow heavy loads as close as possible to the ball head.
- ▶ Fasten loads securely to the rear carrier and secure them against sliding around.

Before a journey

Before starting the journey, check the function of the rear lights of the rear carrier.

The maximum power of the rear lights on the rear carrier must not exceed the maximum power of the trailer's rear lights.

To prevent functional limitations and malfunctions affecting driver assistance systems, activate trailer operation accordingly.

For further information:

- ▶ Power consumption, see page 331.
- ▶ Operation with a trailer or rear carrier, see page 333.

Driving with a rear carrier

Loaded rear carriers change the driving and steering behaviour of the vehicle by shifting the centre of gravity.

When loading and driving, bear the following in mind:

- ▶ Do not exceed the permitted axle load or the permitted total weight.
- ▶ Drive cautiously and avoid driving off and braking suddenly or fast cornerings.

Saving fuel

Vehicle equipment

This chapter describes equipment, systems and functions which are offered or may be offered in future on a model-specific basis, even if they are not included in the vehicle in question.

For further information:

Vehicle equipment, see page 8.

Reducing fuel consumption

Principle

The vehicle has a wide range of technologies for reducing consumption and emissions.

Some measures can influence fuel consumption and environmental pollution:

- ▶ Remove unnecessary loads from the vehicle.
- ▶ Remove add-on parts after use, for example, a rear carrier.
- ▶ Close the windows while driving.
- ▶ Check the tyre inflation pressure regularly and increase if necessary.
- ▶ Switch off the engine if stopping for a longer period.
- ▶ Use anticipatory driving and let the vehicle roll more often, for example.
- ▶ Deactivate functions that are not required, for example rear window heating.
- ▶ Have the vehicle serviced regularly.

Adaptive recuperation

Principle

Adaptive recuperation supports an anticipatory and comfort-oriented driving style.

Map data and various sensors analyse the current driving situation, for example the distance to the vehicle in front.

General

Adaptive recuperation is available depending on vehicle equipment and national-market version.

Based on the situation, the system decides whether energy is recovered through recuperation, or how the vehicle rolls.

The recuperation level is adaptive, so that the vehicle decelerates at different rates when coasting to a stop.

Activating/deactivating adaptive recuperation

Adaptive recuperation is deactivated by activating SPORT drive mode.

When changing to another drive mode, adaptive recuperation is activated.

Display

Display in the instrument cluster

Adaptive recuperation can be displayed on the instrument cluster.

For further information:

Power display, see page 160.

Display on the control display

Adaptive recuperation can be displayed on the control display.

For further information:

Current driving condition, see page 167.

Coasting

Principle

The drivetrain allows efficient coasting in the D selector lever position with minimal deceleration. This drive state is called coasting. This reduces fuel consumption, and the vehicle may not consume any fuel.

General

An anticipatory driving style helps to use the function frequently and supports the consumption-reducing effect of coasting.

Coasting is automatically adapted to the driving situation in question.

The coasting drive state is displayed in the Live Vehicle menu as efficient coasting.

For further information:

Current driving condition, see page 167.

Examples of driving situations

If a distance can be covered without foreseeable braking, it is advantageous to roll this distance.

The following examples of driving situations may be suitable for this:

- ▷ Rolling on straight downhill gradient with no obstacles.
- ▷ Rolling to a stop on a section of route without obstacles.

Avoid late or heavy braking.

Operating requirements

- ▷ Selector lever position D is engaged.
- ▷ Brake is not depressed.
- ▷ Accelerator pedal is not operated.

- ▷ System detects a calm and smooth driving style.
- ▷ Engine and transmission are at operating temperature.
- ▷ The system does not detect any obstructive traffic situations or routes.

The function is available in the speed range from approx. 25 km/h, 16 mph to 160 km/h, 100 mph.

Operation via shift paddles

Principle

Depending on the equipment, the coasting drive state can be controlled via the shift paddles.

Activating/deactivating coasting via shift paddles

Operate the right-hand shift paddle for longer to activate.

Operate the left-hand shift paddle to deactivate.

System limits

- ▷ In the case of navigation data that is invalid, outdated or not available.
- ▷ If there are country-dependent restrictions on map-based route sections.
- ▷ With a temporary and variable speed limit, such as at road works.
- ▷ If Cruise Control is active.
- ▷ If the sensors are faulty, soiled or covered.
- ▷ Driving in the handling limit range or on steep uphill or downhill gradients.
- ▷ Battery charge state temporarily too low or too high power requirement in the electrical system.
- ▷ Trailer operation.

Efficient Mode

Principle

Efficient Mode supports an efficient driving style.

The engine is disconnected from the transmission in selector lever position D when certain conditions are met. The vehicle rolls in idle to optimise consumption. Selector lever position D remains engaged.

In addition, the Efficiency Coach displays situation dependent notes to assist with an efficient driving style.

The extended range that is achieved by adopting these tips is shown in the instrument cluster as a bonus range.

Overview

Button in the vehicle

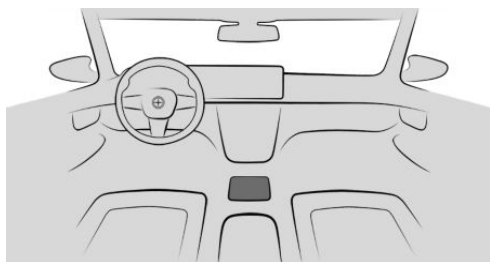

My Modes

Configuring Efficient Mode

1.  Press the button.
2. "EFFICIENT"
3. "Settings"
4. Select the desired setting.

Resetting settings

1.  Press the button.
2. "EFFICIENT"
3. "Settings"
4. "Reset settings"

Efficiency Coach

Principle

The system provides assistance for a predictive and comfort oriented driving style. For this purpose, map information and sensor data is used to analyse the current driving situation, such as upcoming speed limits and vehicles driving in front. Based on this information, the driver receives notices for an efficient driving style early on. The efficiency of the driving style is evaluated in the control display and shown in three categories.

General

The system has different displays to support the driver with an efficient driving style.

Operating requirements

- ▶ Selector lever position D is engaged.
- ▶ Efficient mode is activated.

Display

Power display

When the Efficient Mode is activated, the display changes to a special configuration.

Depending on the equipment, some system information can also be displayed in the Head-up display.

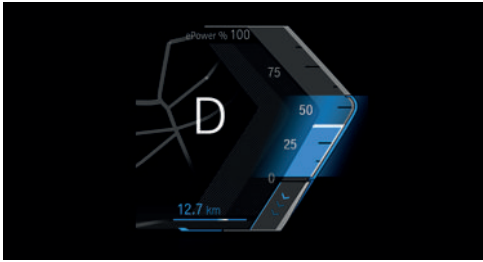

The efficient range of the power display is coloured blue. Additionally, the bonus range will be displayed.

The efficient range is adjusted depending on the driving situation.

If the power display moves within the blue range, the current driving style is efficient. The display will change to grey if the driving style is inefficient.

Bonus range

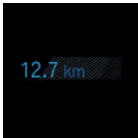

It is possible to achieve a range extension by adjusting the driving style.

The range extension is displayed as the bonus range in the instrument cluster.

If the bonus range is shown in grey or hidden, the current driving style is inefficient.

The display turns blue as soon as all the conditions for consumption-optimised driving are met.

The intervals for resetting the bonus range depend on the trip data settings.

Display inefficient driving style



When driving above the efficient range, an arrow will be displayed.

For example, the display occurs in the following situations:

- ▷ Excessive acceleration.
- ▷ Excessive speed.
- ▷ Special route section, for example roundabout, ahead.

In addition, a deceleration notification is displayed.

System limits

For example, the function is not available in the following situations:

- ▷ If Cruise Control is active.
- ▷ In trailer operation.

Anticipatory driving style

Principle

The display informs the driver about decelerations ahead, for example, speed limit reductions or roundabouts, even when they are not yet visible. The situation-specific information and distance to the route section ahead is shown above the current speed limit in the instrument cluster. If there is a notice, the speed can be reduced in an energy-saving way by coasting using the corresponding accelerator pedal position until the section of road is reached.

The system promptly makes a recommendation to the driver to slow down by reducing the efficient range in the power display. The reduced efficient range in the power display is displayed until the efficient range is reached.

Display in the instrument cluster

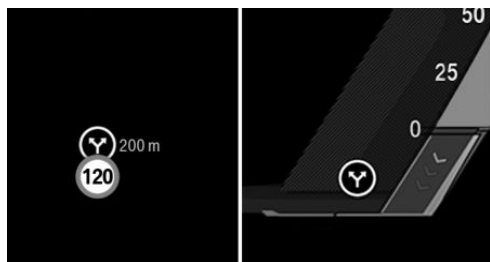

A note regarding a section of the route ahead is given as a recommendation to allow the vehicle to roll.

An icon, for example a turn, indicates the detected section of the route:

Icon	Section of the road in front
	Turning.
	Speed limit or town entrance.
	Roundabout.
	Departure.
	Corner.

System limits

For example, the display of the upcoming route sections is not available in the following situations:

- ▶ With temporary and variable speed limits, for example, at road works.
- ▶ In the case of navigation data that is invalid, outdated or not available.
- ▶ If there are country-dependent restrictions on map-based route sections.

Efficiency evaluation

General

The efficiency of the driving style is evaluated in the control display and shown in three categories, e.g. accelerate. The current trip is analysed.

Operating requirements

The function is available in Efficient Mode.

Going to efficiency evaluation

1. Apps menu
2. "Vehicle"
3. "Live Vehicle"

For further information:

Live Vehicle, see page [149](#)

Display on the control display

The display of the efficiency analysis shows the efficiency of the driving style.

The more efficient the driving style, the larger the area that is displayed in colour and the faster the bonus range increases.

In contrast, a reduced area will be displayed with an inefficient driving style.

Refuelling

Vehicle equipment

This chapter describes equipment, systems and functions which are offered or may be offered in future on a model-specific basis, even if they are not included in the vehicle in question.

For further information:

Vehicle equipment, see page 8.

Things to consider when refuelling

General

Before refuelling, take note of the fuel grade information.

On vehicles with diesel engine, the fuel filler neck is designed for refuelling at diesel pumps.

When topping up, hook the fuel pump nozzle fully into the filler pipe. Lifting the fuel pump nozzle while topping up will cause the following to happen:

- ▶ The supply is stopped too soon.
- ▶ Fuel vapour recovery is less effective.

The fuel tank is full when the fuel pump nozzle cuts out for the first time.

Please comply with the safety regulations displayed at filling stations.

For further information:

Fuel grade, see page 374.

Safety information

NOTICE

If the range drops below 50 km, approx. 30 miles, the engine may no longer be supplied with sufficient fuel. The engine functions are no longer ensured. There is a risk of material damage. Refuel in good time.

NOTICE

Fuels are poisonous and aggressive substances. Overfilling the fuel tank can damage the fuel system. If fuel comes into contact with paintwork, it can damage it. The environment is polluted. There is a risk of material damage. Avoid overfilling.

Fuel filler cap

Safety information

WARNING

The retaining strap of the fuel filler cap may become trapped and crushed when turning the cap to close it. As a result, the cap may not be closed properly. Fuel or fuel vapours can leak out. There is a danger of injury or material damage. Make sure that the retaining strap does not get trapped and crushed when closing the cap.

Opening

1. To open the fuel filler flap, press on the rear edge, arrow. The fuel filler flap opens.

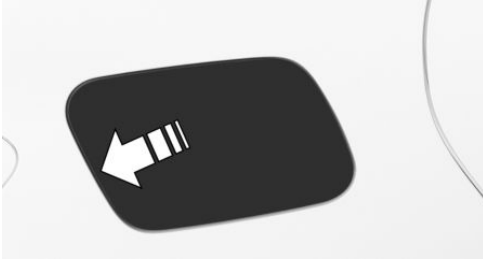

2. Turn the fuel filler cap anticlockwise.

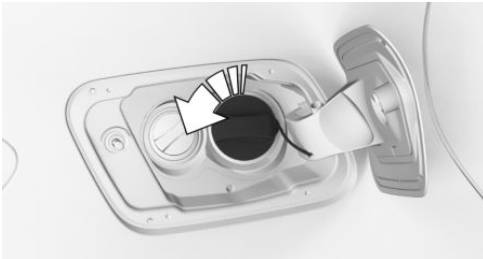

3. Place the fuel filler cap in the holder on the fuel filler flap.

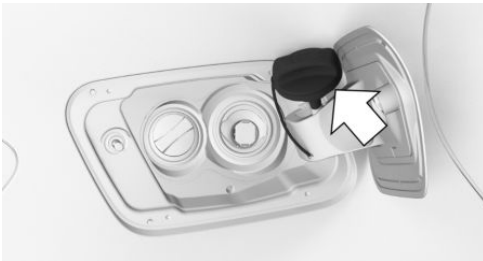

Closing

1. Fit the fuel filler cap and turn clockwise until it is clearly heard to click into place.
2. Press on the fuel filler flap until it engages.

Emergency release

In certain situations, it may be necessary to unlock the fuel filler flap manually, for example if there is an electrical fault.

Have the fuel filler flap unlocked by an authorised Service Partner or another qualified Service Partner or a specialist workshop.

Wheels and tyres

Vehicle equipment

This chapter describes equipment, systems and functions which are offered or may be offered in future on a model-specific basis, even if they are not included in the vehicle in question.

For further information:

Vehicle equipment, see page 8.

Tyre inflation pressure

General

The tyre condition and tyre inflation pressure influence the following:

- ▶ Tyre service life.
- ▶ Driving safety.
- ▶ Driving comfort.
- ▶ Fuel consumption.

Safety information

WARNING

A tyre with too little or no tyre inflation pressure can heat up significantly and sustain damage. Handling characteristics, for example steering and braking, will be impaired as a result. There is a risk of accident. Check the tyre inflation pressure regularly, for example twice a month or before any long journey, and correct as necessary.

Tyre inflation pressure information

On the body pillar



The tyre inflation pressure information is located on the body pillar of the driver's door.

The tyre inflation pressures apply to all tyre sizes and recommended tyre makes that have been approved by the vehicle manufacturer as suitable for the model version. The list can also include tyre sizes that are only suitable in combination with specific equipment.

Information about approved wheels and tyres for the vehicle can be requested from an authorised Service Partner or another qualified Service Partner or specialist workshop.

The tyre inflation pressure appropriate for the respective load conditions should be used. For partially loaded vehicles, the specified tyre inflation pressure for a partially loaded vehicle, for example, is the optimum tyre inflation pressure.

For Australia/New Zealand

WARNING

The inflation pressures on the tyre label are applicable only for tyre types explicitly mentioned on the label. Tyre inflation pressures that may be covered by the label – by size, speed category and load rating/load index –

but not explicitly mentioned on the label may be different. Please obtain adequate inflation pressures in accordance with the tyre manufacturer's specifications from your tyre dealer.

On the control display

The current tyre inflation pressures and the specified tyre inflation pressures for the installed tyres can be displayed on the control display.

To ensure that they are displayed correctly, the tyre sizes must be stored in the system and must have been set for the fitted tyres.

The current tyre inflation pressure value is shown on each tyre.

The specified tyre inflation pressure value is located towards the bottom of the control display.

Checking the tyre inflation pressure

General

The tyres heat up while driving. The tyre inflation pressure increases with the temperature of the tyre.

The tyres have a natural, uniform tyre pressure loss.

The pressures displayed by some pressure gauges may be up to 0.1 bar too low.

Checking using tyre inflation pressure information on the body pillar

1. Determine the specified tyre inflation pressures for the tyres installed on the vehicle.
2. Check the tyre inflation pressure in all four tyres, using a pressure gauge, for example.
3. Correct the tyre inflation pressure if the current tyre inflation pressure deviates from the specified tyre inflation pressure.
4. Check that all valve caps are screwed onto the tyre valves.

The tyre inflation pressure information on the tyre pressure label on the body pillar only relates to cold tyres or tyres at the same temperature as the ambient temperature.

Only check the tyre inflation pressures when the tyres are cold, i.e.:

- ▷ If the vehicle has been driven a distance of no more than 2 km, 1.25 miles.
- ▷ If the vehicle has not moved again for at least 2 hours after a journey.

If equipped with an emergency tyre: check the tyre inflation pressure of the emergency wheel in the luggage compartment regularly and correct if necessary.

Checking using the tyre inflation pressure information on the control display

1.  Apps menu
2. "Vehicle"
3. "Vehicle status"
4. "Tyre Pressure Monitor"
5. Check if the current tyre inflation pressures match the specified tyre pressure value.
6. Correct the tyre inflation pressure if the current tyre inflation pressure deviates from the specified tyre inflation pressure.

The current tyre inflation pressure on the control display may be restricted when the vehicle is stationary. The tyre inflation pressure is updated after a short drive.

After adjusting the tyre inflation pressure

If equipped with a Tyre Pressure Monitor, tyre inflation pressure corrections are applied automatically. Make sure that the tyre settings are correct. For tyres that are not listed in the tyre inflation pressure information on the control display, reset the Tyre Pressure Monitor.

If equipped with a Flat Tyre Monitor, reinitialize the Flat Tyre Monitor.

Tyre tread

Safety information

WARNING

If the tyre tread depth is too low, safety may be impaired in critical situations, e.g., aquaplaning or driving on slush. There is a risk of accident. Note the minimum tyre tread depth of 3 mm, approx. 0.12 in for summer tyres, and 4 mm, approx. 0.16 in for winter and all-season tyres, or follow applicable legal requirements for minimum tread depth.

- ▷ Unusual vibrations.
- ▷ Unusual tyre or running noises.
- ▷ Unusual vehicle response, such as pronounced pulling to the left or right.
- ▷ Uneven wear pattern, for example increased wear near the tyre shoulder.

Damage can be caused by situations such as the following:

- ▷ Driving over kerbs.
- ▷ Road damage.
- ▷ Tyre inflation pressure too low.
- ▷ Overloading the vehicle.
- ▷ Incorrect tyre storage.

Minimum tread depth

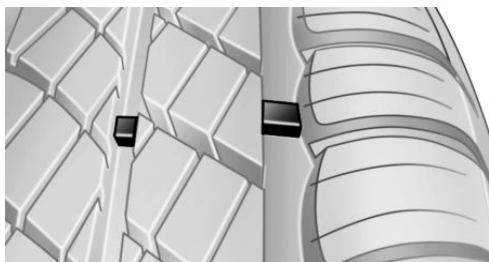

There are wear indicators from the tyre manufacturer distributed over the tyre circumference with a height of at least 1.6 mm, approx. 0.06 in, which serve as an indicator of tyre tread wear.

The positions of the wear indicators are identified on the tyre sidewall by TWI, Tread Wear Indicator.

Tyre damages

General

Inspect tyres regularly for damage, the presence of foreign bodies and wear.

Symptoms that may indicate tyre damage or a malfunction:

Safety information

WARNING

If the tyres are damaged, the tyre inflation pressure may be reduced, causing you to lose control of the vehicle. There is a risk of accident. If you suspect tyre damage while you are driving, immediately reduce speed and bring the vehicle to a stop. Have the wheels and tyres checked. To do so, carefully drive to an authorised Service Partner or another qualified Service Partner or a specialist workshop. If necessary, have the vehicle towed or transported there. Do not repair damaged tyres. Have them replaced.

WARNING

Driving over kerbs, potholes, or other obstacles can damage the wheels, tyres, and suspension components. Larger wheels have a smaller tyre cross-section. The smaller the tyre cross-section, the higher the risk of tyre damage. There is a risk of accident and material damage. Avoid kerbs, potholes, or other obstacles whenever possible, or drive over them slowly and carefully.

Tyre age

Recommendation

Irrespective of the tyre tread depth, change tyres after 6 years at the latest.

Production date

The production date of the tyre can be found on the tyre sidewall.

Designation	Production date
DOT ... 1923	19th week of 2023

Replacement of wheels and tyres

Fitting and balancing

Have the wheel fitted and balanced by an authorised Service Partner or another qualified Service Partner or a specialist workshop.

Suitable wheels and tyres

General

Depending on the vehicle and equipment, only certain wheel/tyre combinations are suitable. The wheel/tyre combinations are determined by the manufacturer of the vehicle on the basis of the following criteria:

- ▷ Tyre size; for example, tyre width, aspect ratio.
- ▷ Wheel size; for example rim diameter, offset.

Information on the suitable wheels and tyres for the vehicle, as well as the special equipment, can be obtained from an authorised Service Partner, another qualified Service Partner or a specialist workshop.

Safety information

WARNING

Wheels and tyres that are not suitable for the vehicle can damage parts of the vehicle. There is a risk of accident. The manufacturer of the vehicle recommends only using wheels and tyres that have been approved as suitable for the vehicle type concerned.

WARNING

Mounted steel wheels can lead to technical problems, for example wheel bolts may work loose and brake discs may be damaged. There is a risk of accident. Do not install steel wheels.

WARNING

Wheel and tyre combinations that are unsuitable for the vehicle can impair the vehicle's driving characteristics and various system functions, for example, the Anti-lock Braking System (ABS) or Dynamic Stability Control. There is a risk of accident. The manufacturer of the vehicle recommends using wheels and tyres that have been rated as suitable for the vehicle type concerned. After a tyre has been damaged, refit the same wheel/tyre combination as the original.

Recommended makes of tyre



For each vehicle, tyre types are developed that are optimised specifically for the individual requirements of the vehicle. For example:

- ▷ Handling.
- ▷ Comfort.
- ▷ Noise characteristics.

The specially developed tyres are marked with a star on the tyre sidewall. After replacing wheels and tyres, the vehicle manufacturer recommends using tyres with a star marking again. The manufacturer of the vehicle recommends that tyres of the same make and tread design are used.

New tyres

Due to the manufacturing process, new tyres do not achieve their full road grip immediately.

Drive moderately for the first 300 km, 200 miles.

Retreaded tyres

WARNING

Retreaded tyres may have different tyre carcasses. Their durability may be restricted due to their advanced age. There is a risk of accident. The vehicle manufacturer advises against the use of retreaded tyres.

Maximum speed

Safety information

WARNING

If the maximum permitted speed of the fitted tyres is exceeded, the tyres may be damaged. There is a risk of accident. Do not exceed the maximum permitted speed of the tyres.

Speed index

The maximum permitted speed of the tyres is indicated by the speed index.

The speed index can be found in the official tyre designation on the tyre sidewall.

Designation	Maximum speed
Q	up to 160 km/h, 100 mph
R	up to 170 km/h, 106 mph
S	up to 180 km/h, 112 mph
T	up to 190 km/h, 118 mph
H	up to 210 km/h, 131 mph
F	up to 240 km/h, 150 mph
W	up to 270 km/h, 167 mph
Y	up to 300 km/h, 186 mph
(Y)	above 300 km/h, 186 mph

Maximum speed of winter tyres

If the maximum speed of the vehicle is higher than the maximum permissible speed for winter tyres, a sign with the maximum permissible speed must be displayed in the field of view. The sign is available from an authorised Service Partner or another qualified Service Partner or a specialist workshop.

Winter tyres



Winter tyres are recommended if driving in winter conditions.

"The winter tyres are identified on the tyre sidewall by a icon with mountain and snowflake, as well as by the lettering M+S.

So-called all-season tyres with M+S marking but without icon with mountain and snowflake have better winter properties than summer tyres. As a rule, all-season tyres do not achieve the performance of winter tyres.

Wheel change between axles

WARNING

Wheel change between axles on vehicles with different tyre sizes or rims on the front and rear may cause tyre damage and damage to the vehicle. There is a risk of accident. Do not swap wheels between axles on vehicles with different tyre sizes or rims on the front and rear.

Depending on the individual operating conditions, the tyre tread wears differently on the front and rear axles. To achieve even abrasion, the tyres can be swapped in pairs between the axles. Additional information is available from an authorised Service Partner or another qualified Service Partner or a specialist workshop. After changing the wheels, check the tyre inflation pressure and correct if necessary.

Storing tyres

Tyre inflation pressure

Do not exceed the maximum tyre inflation pressure indicated on the tyre sidewall.

Storage

- ▶ Store wheels and tyres in a cool, dry and dark place when not in use.
- ▶ Protect the tyres against contamination from oil, grease and solvents.
- ▶ Do not leave tyres in plastic bags.
- ▶ Remove dirt from the wheels or tyres.

Remedying a flat tyre

Safety measures

- ▶ Park the vehicle on firm and non-slip ground at a safe distance from traffic.
- ▶ Switch on the hazard warning lights.
- ▶ Apply the parking brake.
- ▶ Engage the steering wheel lock with the wheels in the straight-ahead position.
- ▶ As soon as the traffic flow permits, have all vehicle occupants get out of the vehicle and guide them out of the danger area, for example behind the crash barrier.
- ▶ If necessary, set up the hazard triangle or hazard warning lamp at an appropriate distance.

Tyre repair kit

Principle

With the tyre repair kit, minor tyre damage can be quickly sealed to allow the driver to continue driving.

General

- ▶ The filled in tyre sealant encloses the damage from the inside when it hardens.
- ▶ Please observe the notes on using the tyre repair kit which are on the compressor and the tyre sealant bottle.
- ▶ The use of the tyre repair set can be ineffective in the event of tyre damage from a size of approx. 4 mm, approx. 0.16 in.
- ▶ Foreign bodies that have penetrated the tyre should remain inside the tyre. Only remove foreign objects if they are visibly protruding from the tyre.
- ▶ The compressor can be used to check the tyre inflation pressure.

Overview

Storage

Depending on the equipment, storage for the tyre repair set is provided as follows:

- ▶ In the luggage compartment under the luggage compartment floor.
- ▶ In the luggage compartment on the left or right side.
- ▶ In the luggage compartment behind a side trim panel.

Tyre sealant bottle and filler hose



- 1 Tyre sealant bottle
- 2 Tyre sealant bottle outlet
- 3 Filler hose

- 4 Tyre sealant bottle connection
- 5 Wheel valve connection

Compressor



- 1 Compressor
- 2 Tyre inflation pressure indicator
- 3 Pressure reducing valve button
- 4 Tyre sealant bottle holder
- 5 Connector for socket
- 6 On/off switch

Safety measures

- ▶ Park the vehicle on a firm surface and as far away from moving traffic as possible.
- ▶ Switch on the hazard warning lights.
- ▶ Apply the parking brake.
- ▶ Engage the steering wheel lock with the wheels in the straight-ahead position.
- ▶ As soon as the traffic flow permits, have all vehicle occupants get out of the vehicle and guide them out of the danger area, for example behind the crash barrier.
- ▶ If necessary, set up the hazard triangle or hazard warning lamp at an appropriate distance.
- ▶ Remove the warning sign for the maximum permissible speed from the compressor and attach it in the visible area in the vehicle interior.
- ▶ Remove the warning sign from the tyre sealant bottle and stick it on the wheel rim.

Preparing the tyre repair kit

1. Insert the tyre sealant bottle into the mount on the housing of the compressor.

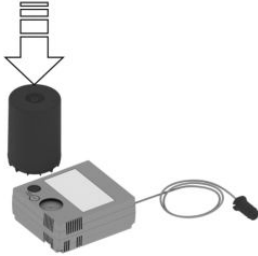

2. Turn the tyre sealant bottle clockwise by 90° to the stop.

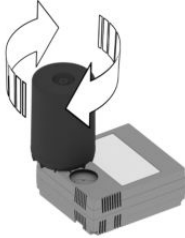

3. Connect the filler hose to the outlet of the tyre sealant bottle and turn clockwise by 90° to the stop.



4. Unscrew the valve cap from the wheel and screw the connecting piece of the filler hose onto the valve.

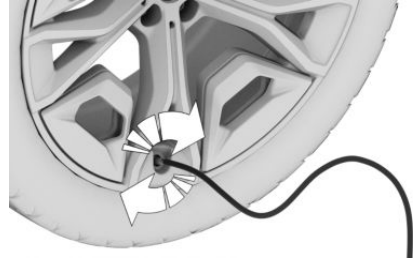

5. With the compressor switched off, insert the plug into the socket inside the vehicle interior.

Filling with tyre sealant

Safety information

DANGER

A blocked exhaust pipe or inadequate ventilation can allow harmful exhaust fumes to enter the vehicle. The exhaust fumes contain pollutants which are colourless and odourless. In enclosed spaces, exhaust fumes can also build up outside the vehicle. There is a danger to life. Keep the exhaust pipe clear and ensure sufficient ventilation.

NOTICE

The compressor can overheat if operated for too long. There is a risk of material damage. Do not let the compressor run for longer than 10 minutes.

Filling with tyre sealant

1. Switch on the compressor with standby state or drive-ready state switched on.

Let the compressor run for max. 10 minutes to fill in the tyre sealant and reach a tyre inflation pressure of 2.5 bar.

While the tyre is being filled with tyre sealant, the tyre pressure can briefly reach approx. 6 bar. Do not turn off the compressor in this phase.



2. Switch off compressor.

Checking the tyre inflation pressure

Read the tyre pressure on the tyre inflation pressure indicator of the compressor. The tyre pressure must be at least 2.5 bar.

Tyre pressure too high

If the tyre inflation pressure is too high, reduce the tyre pressure with the pressure reducing valve on the compressor.

Minimum tyre inflation pressure is not reached

Do not continue driving unless a minimum tyre pressure of 2.5 bar is reached. Contact an authorised Service Partner or another qualified Service Partner or a specialist workshop.

Minimum tyre inflation pressure is reached

1. Pull the connector out of the socket in the vehicle interior.
2. Disconnect the hose from the tyre sealant bottle and the valve on the wheel.
3. Screw the valve cap onto the valve.

4. Stow the tyre repair kit in the luggage compartment.
5. Immediately drive for approximately 10 km/5 miles to evenly distribute the tyre sealant in the tyre.

Do not exceed the permitted maximum speed of 80 km/h, approx. 50 mph.

If possible, do not drive slower than 20 km/h/12 mph.

Tyre sealant may spray from the damaged area during the initial wheel rotations.

Adjusting the tyre pressure

1. Stop in a suitable area.
2. Connect the hose directly to the compressor and turn clockwise by 90° until it audibly engages.



3. Unscrew the valve cap from the wheel and screw the connecting piece of the hose onto the valve.

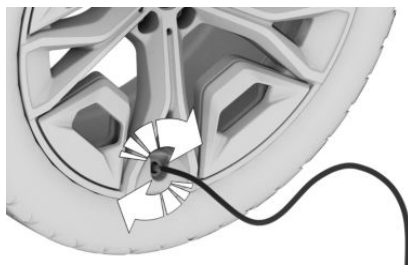

4. Insert the connector into the socket in the vehicle interior.
5. Read the tyre pressure on the tyre inflation pressure indicator of the compressor.

Do not continue driving unless a minimum tyre pressure of 1.3 bar is displayed. Contact an authorised Service Partner or another qualified Service Partner or a specialist workshop.

6. Correct the tyre pressure to 2.5 bar.
 - ▶ Increase tyre inflation pressure: with standby or drive-ready state turned on, turn on the compressor and let it run for a maximum of 10 minutes.
 - ▶ Reduce tyre inflation pressure: press the pressure reducing valve button on the compressor.

Removing and stowing the tyre repair kit

1. Switch off compressor.
2. Pull the connector out of the socket in the vehicle interior.
3. Disconnect the hose from the compressor and the valve on the wheel.
4. Screw the valve cap onto the valve.
5. Stow the tyre repair kit in the luggage compartment.

Resuming a journey

Do not exceed the permitted maximum speed of 80 km/h, approx. 50 mph.

Do not exceed a maximum distance travelled of 200 km/125 miles.

Re-initialise the flat tyre monitor or reset the Tyre Pressure Monitor.

Have the punctured tyre and the tyre sealant bottle of the tyre repair kit replaced as soon as possible.

For further information:

- ▶ Flat Tyre Monitor, see page [364](#).
- ▶ Tyre Pressure Monitor, see page [358](#).

System limits

Contact an authorised Service Partner or another qualified Service Partner or a specialist workshop if you are unable to put the tyre back in operation.

With Tyre Pressure Monitor: using sealant can damage the air pressure sensor. In this case, have the electronics replaced at the next opportunity.

Snow chains

Safety information

WARNING

If snow chains are fitted to unsuitable tyres, the snow chains can come into contact with parts of the vehicle. There is a risk of accident or material damage. Only fit snow chains on tyres that the vehicle manufacturer has classified as suitable for use with snow chains.

WARNING

Insufficiently tensioned snow chains can damage tyres and vehicle components. There is a risk of accident or material damage. Ensure that snow chains are always adequately tensioned. Re-tension them if necessary in accordance with the snow chain manufacturer's instructions.

Fine-link snow chains

The vehicle manufacturer recommends using fine-link snow chains. Certain fine-link snow chains have been tested, found safe for use in traffic and rated as suitable by the manufacturer of the vehicle.

Information regarding suitable snow chains is available from an authorised Service Partner or

another qualified Service Partner or a specialist workshop.

Use

Use only in pairs on the rear wheels, equipped with the tyres of the following wheel/tyre sizes:

Tyre size	Wheel size	Rim offset (IS)
225/55 R18	7.5J x 18	23
245/45 R19	8.5J x 19	29

The information on wheel size and rim offset is located on the inside of the wheel.

The list can also include wheel/tyre sizes that are only suitable for certain models.

Information about approved wheels and tyres for the vehicle can be requested from an authorised Service Partner or another qualified Service Partner or specialist workshop.

Observe the snow chain manufacturer's instructions.

If equipped with a Tyre Pressure Monitor: do not reset the Tyre Pressure Monitor when using snow chains. Otherwise, incorrect values may be displayed.

If equipped with a flat tyre monitor: do not initialise the flat tyre monitor when using snow chains. Otherwise, incorrect values may be displayed.

When driving with snow chains, activate the drive-off support to optimise propulsion, if necessary.

Maximum speed with snow chains

When snow chains are fitted, do not exceed 50 km/h, 30 mph.

Rear-wheel steering with snow chains

General

In order to guarantee freedom of movement of the wheels when operating with snow chains, rear-wheel steering must be turned off when snow chains are mounted.

The rear-wheel steering is switched on again automatically above the permitted maximum speed for snow chains of 50 km/h, approx. 30 mph.

The setting for fitted snow chains is possible only below 50 km/h, approx. 30 mph.

Safety information

WARNING

If the rear-wheel steering is activated while snow chains are fitted, the snow chains may come into contact with the vehicle bodywork. There is a risk of accident or material damage. Switch off the rear-wheel steering when snow chains are fitted.

Switching off the rear-wheel steering

The rear-wheel steering is switched off by selecting the 'snow chains fitted' setting.

1.  Apps menu
2. "Vehicle"
3. "Driving settings"
4. "Drivetrain and chassis"
5. "Snow chains"

Tyre Pressure Monitor

Principle

The Tyre Pressure Monitor monitors the tyre pressure and issues a warning if the tyre pressure has dropped.

General

Sensors in the tyre valves measure the tyre inflation pressure and tyre air temperature.

Depending on the tyres detected or entered, the system displays the specified nominal pressures on the control display and compares them to the current tyre inflation pressures.

If the vehicle is fitted with tyres which are not listed in the tyre inflation pressure information on the vehicle, for example tyres with special approval, the system must be actively reset. The current tyre inflation pressures are then accepted as the nominal pressures.

When operating the system, please also comply with the information and notes in the chapter on tyre inflation pressure.

For further information:

Tyre inflation pressure, see page 348.

Safety information

WARNING

The display showing the nominal pressures does not replace the tyre inflation pressure information on the vehicle. If incorrect data has been entered into the tyre settings, the specified tyre inflation pressures will also be incorrect. As a result, reliable message of a tyre pressure loss can no longer be guaranteed. There is a danger of injury or material damage. Make sure that the sizes of fitted tyres are displayed correctly, and that the sizes match the information given on the tyres and tyre inflation pressure inscriptions on the vehicle.

Operating requirements

The following requirements must be met for the system, otherwise reliable message of a tyre pressure loss is not ensured:

- ▷ After each tyre or wheel change, the system has detected the fitted tyres, updated

the relevant information and, after a short journey, shown it on the control display.

If the system does not detect the tyres automatically, enter the specifications for the fitted tyres in the tyre settings.

- ▷ The Tyre Pressure Monitor only becomes active after driving for several minutes:
 - ▷ After tyre/wheel change.
 - ▷ After a reset, for tyres with special approval.
 - ▷ After changing the tyre setting.
- ▷ For tyres with special approval:
 - ▷ After every tyre or wheel change, the system must be reset once the tyre inflation pressure is correct.
 - ▷ A reset must be carried out after the tyre inflation pressure has been adjusted to a new value.
- ▷ Wheels with air pressure sensor.

Tyre settings

General

If the system does not detect the tyres automatically, the specifications for the fitted tyres can be entered in the tyre settings.

The tyre sizes of the fitted tyres can be found in the tyre inflation pressure information on the vehicle or directly on the tyres.

The tyre data does not have to be re-entered if the tyre inflation pressure is being corrected.

For summer and winter tyres, the tyre data last entered for each type is saved. This means that the settings can be selected again after a tyre or wheel change.

Adjusting tyres

1.  Apps menu
2. "Vehicle"
3. "Vehicle status"
4. "Tyre Pressure Monitor"

5. "Tyre settings"
6. "Tyre selection"
7. "Manual"
8. "Tyre type"
9. Select the tyre size that is mounted on the rear axle.
For tyres with special approval:
"Other tyres"
See the Performing a reset section for how to proceed.
10. After selecting the tyre size, select the load status of the vehicle.
11. "Save tyre settings"

The measurement of the current tyre inflation pressure is started. The progress of the measurement is shown.

Status display

Current status

The status of the system, for example whether the system is active, can be shown on the control display.

1.  Apps menu
2. "Vehicle"
3. "Vehicle status"
4. "Tyre Pressure Monitor"

The current status is displayed.

Current tyre inflation pressure

The current tyre inflation pressure is displayed for each tyre.

The current tyre inflation pressures can vary depending on vehicle operation or outside temperature.

Current tyre air temperature

The current tyre air temperatures are shown depending on the model.

The current tyre air temperatures can change as a result of driving the vehicle or the outside temperature.

Nominal pressure

The nominal pressure for the tyres on the front and rear axle is displayed.

The stated nominal pressure takes account of the temperature effects caused by driving the vehicle and the outside temperature. The appropriate nominal pressure is always displayed irrespective of the weather conditions, tyre air temperatures and length of journey.

The displayed nominal pressure may vary and differ from the value stated in the tyre inflation pressure information on the body pillar of the driver's door. The tyre inflation pressure can thus be corrected to the value of the displayed nominal pressures.

The nominal pressure is adjusted immediately if the load status is changed in the tyre settings.

Tyre statuses

General

The status of the system and tyres is indicated by the wheel colour and a message on the control display.

Existing messages may not be deleted if the nominal pressure is not reached when the tyre inflation pressure is corrected.

All wheels green

- ▷ The system is active and bases any warnings on the nominal pressures.
- ▷ In the case of tyres with special approval: the system is active and bases its warnings on the tyre inflation pressures saved at the last reset.

One to four wheels yellow

There is a flat tyre or major tyre pressure loss in the tyres shown.

Wheels grey

Tyre pressure losses might not be detected.

Possible causes:

- ▷ Malfunction.
- ▷ The tyre inflation pressure is being measured, after confirmation of the tyre settings.
- ▷ For tyres with special approval: a system reset is being performed.

For tyres with special approval: performing a reset

1.  Apps menu
2. "Vehicle"
3. "Vehicle status"
4. "Tyre Pressure Monitor"
5. Make sure that the tyre settings are correct. Tyre settings, see page [359](#).
6. Switch on drive-ready state but do not drive off.
7. Reset the tyre inflation pressure: "Perform reset"
8. Drive off.

The wheels are shown grey and the following appears on the display: "Resetting tyre pressure...".

After driving for several minutes, the set tyre inflation pressures are accepted as the specified tyre inflation pressures. The reset is completed automatically during the journey.

If the reset was successful, the wheels are shown in green on the control display and the following appears: "Reset successful."

You can interrupt your journey at any time. The reset resumes automatically when you continue driving.

Messages: for tyres without special approval

General

When a low tyre pressure is indicated, the Dynamic Stability Control may be turned on.

Safety information

WARNING

A damaged standard tyre with too little or no tyre inflation pressure impairs driving characteristics, for example steering and braking. There is a risk of accident. Do not continue driving. Repair the flat tyre or replace the wheel.

With recommended tyre pressure check

Message

An icon with service information is shown on the control display and, if necessary, in the My BMW App.

Icon	Possible cause
	Leak detected on the tyre.

Measure

Check the tyre inflation pressure and adjust as necessary.

If a tyre inflation pressure check is required

Message

An icon with a Check Control message is shown on the control display.

Icon Possible cause

The tyre was not inflated properly, for example insufficient air was added or there was a natural, even tyre pressure loss.

Measure

Check the tyre inflation pressure and adjust as necessary.

If the tyre inflation pressure is too low**Message**

A yellow warning light is illuminated in the instrument cluster.

In addition, an icon with a Check Control message is shown on the control display.

Icon Possible cause

There has been a tyre pressure loss.

Measure

1. Reduce speed. Do not exceed a speed of 130 km/h, 80 mph.
2. At the next opportunity, for example at a filling station, check the tyre inflation pressure in all four tyres and correct if necessary.

If there is a significant tyre pressure loss**Message**

A yellow warning light is illuminated in the instrument cluster.

In addition, an icon indicating which tyre is affected is shown in a Check Control message on the control display.

Icon Possible cause

There is a flat tyre or substantial tyre pressure loss.

Measure

1. Reduce your speed and carefully stop the vehicle. Avoid heavy braking and sudden steering manoeuvres.
2. Follow the description of what to do when the vehicle gets a flat tyre.

What to do in the event of a flat tyre, see page 363.

Messages: for tyres with special approval**General**

When a low tyre pressure is indicated, the Dynamic Stability Control may be turned on.

Safety information**! WARNING**

A damaged standard tyre with too little or no tyre inflation pressure impairs driving characteristics, for example steering and braking. There is a risk of accident. Do not continue driving. Repair the flat tyre or replace the wheel.

If a tyre inflation pressure check is required**Message**

An icon with a Check Control message is shown on the control display.

Icon	Possible cause
------	----------------



The tyre was not inflated properly, for example insufficient air was added.

The system has detected a wheel change, but no reset has been performed.

The tyre inflation pressure has dropped compared to the last reset.

No reset has been performed on the system. System warning is based on the tyre inflation pressures saved during the last reset.

Measure

1. Check the tyre inflation pressure and adjust as necessary.
2. Perform a system reset.

If the tyre inflation pressure is too low

Message



A yellow warning light is illuminated in the instrument cluster.

In addition, an icon with a Check Control message is shown on the control display.

Icon	Possible cause
------	----------------



There has been a tyre pressure loss.

No reset has been performed on the system. System warning is based on the tyre inflation pressures saved during the last reset.

Measure

1. Reduce speed. Do not exceed a speed of 130 km/h, 80 mph.
2. At the next opportunity, for example at a filling station, check the tyre inflation pres-

sure in all four tyres and correct if necessary.

3. Perform a system reset.

If there is a significant tyre pressure loss

Message



A yellow warning light is illuminated in the instrument cluster.

In addition, an icon indicating which tyre is affected is shown in a Check Control message on the control display.

Icon	Possible cause
------	----------------



There is a flat tyre or substantial tyre pressure loss.

No reset has been performed on the system. System warning is based on the tyre inflation pressures saved during the last reset.

Measure

1. Reduce your speed and carefully stop the vehicle. Avoid heavy braking and sudden steering manoeuvres.
2. Follow the description of what to do when the vehicle gets a flat tyre.

What to do in the event of a flat tyre, see page 363.

What to do in the event of a flat tyre

1. Identify the damaged tyre.

Check the tyre inflation pressure in all four tyres, for example using the tyre inflation pressure indicator of a tyre repair kit.

For tyres with special approval: if all four tyres are inflated to the correct tyre inflation pressures, the Tyre Pressure Monitor might not have been reset. Perform a reset.

If no tyre damage can be found, contact an authorised Service Partner or another

qualified Service Partner or a specialist workshop.

2. Repair the flat tyre, for example using a tyre repair kit or by changing the wheel.

The use of tyre sealant, for example a tyre repair kit, can damage the wheel electronics. Have the electronics replaced at the next opportunity.

System limits

Temperature

The tyre inflation pressure depends on the temperature of the tyre.

The tyre inflation pressure increases as the tyre air temperature increases, for example while driving or when exposed to sunlight.

The tyre inflation pressure decreases when the tyre air temperature drops.

Due to the given warning thresholds, therefore, this behaviour may cause a warning to be triggered when significant temperature drops occur.

After a temperature-related warning, the nominal pressures are displayed again on the control display after driving a short distance.

Sudden tyre pressure loss

No warning can be given by the system in the event of extreme, sudden tyre damages caused by external factors.

Reset not carried out

Tyres with special approval: the system will not function correctly if a reset has not been carried out, for example, a flat tyre may be reported even though the tyre pressure is correct.

Malfuction

Message



The yellow warning light flashes and then illuminates continuously. A Check Control message is shown. Tyre pressure losses may not be detected.

Measure

- ▷ A wheel without air pressure sensor is fitted: have the wheels checked if necessary.
- ▷ Fault due to systems or devices with the same transmission frequency: the system is automatically reactivated upon leaving the field of interference.
- ▷ For tyres with special approval: the system was unable to complete the reset. Perform a system reset again.
- ▷ If the Tyre Pressure Monitor has failed: have the system checked by an authorised Service Partner or another qualified Service Partner or a specialist workshop.

Flat tyre monitor

Principle

The flat tyre monitor detects a tyre pressure loss while driving and issues a warning if the tyre pressure has dropped.

General

The system identifies a tyre pressure loss by comparing the rotational speeds of the individual wheels during the journey.

A tyre pressure loss changes the diameter, and with it the rotational speed, of the corresponding wheel. The discrepancy is detected and reported as a flat tyre.

The system does not measure the tyre inflation pressure as such.

Operating requirements

The following requirements must be met for the system, otherwise reliable message of a tyre pressure loss is not ensured:

- ▶ After a tyre or wheel change, an initialisation was carried out at the correct tyre inflation pressure.
- ▶ The system must be initialised after the tyre inflation pressure is adjusted to a new value.

Status display

It is possible to display the current status of the Flat Tyre Monitor, for example to check whether the Flat Tyre Monitor is active.

1.  Apps menu
2. "Vehicle"
3. "Vehicle status"
4. "FLAT TYRE MONITOR"

The status is displayed.

Initialisation required

An initialisation must be performed in the following situations:

- ▶ After adjusting the tyre inflation pressure.
- ▶ After tyre/wheel change.

Initialisation

Initialisation saves the set tyre inflation pressures as reference values for subsequent detection of a flat tyre. Initialisation is started by confirming the correct tyre inflation pressures.

Do not initialise the system if driving with snow chains fitted.

1.  Apps menu
2. "Vehicle"
3. "Vehicle status"
4. "FLAT TYRE MONITOR"
5. Switch on drive-ready state but do not drive off.

6. Start the initialisation: "Perform reset"
7. Drive off.

Initialisation is completed while driving which can be interrupted at any time.

Initialisation resumes automatically when you continue driving.

Messages

General

When a flat tyre is indicated, the Dynamic Stability Control is turned on, if needed.

Safety information

WARNING

A damaged standard tyre with too little or no tyre inflation pressure impairs driving characteristics, for example steering and braking. There is a risk of accident. Do not continue driving. Repair the flat tyre or replace the wheel.

Flat tyre message



A yellow warning light is illuminated in the instrument cluster.

In addition, an icon with a Check Control message is shown on the control display.

Icon **Possible cause**



There is a flat tyre or substantial tyre pressure loss.

Measure

1. Reduce your speed and carefully stop the vehicle. Avoid heavy braking and sudden steering manoeuvres.
2. Follow the description of what to do when the vehicle gets a flat tyre.

What to do in the event of a flat tyre

1. Identify the damaged tyre.

To do this, check the tyre inflation pressure in all four tyres, for example using the tyre inflation pressure indicator of a tyre repair kit.

If all four tyres are inflated to the correct tyre inflation pressures, the flat tyre monitor might not have been initialised. In this case initialise the system.

If no tyre damage can be found, contact an authorised Service Partner or another qualified Service Partner or a specialist workshop.

2. Repair the flat tyre, for example using a tyre repair kit or by changing the wheel.

System limits

In the following situations, the system could be slow to respond or could work incorrectly:

- ▶ A natural, even tyre pressure loss in all four tyres that occurs over time will not be detected. Therefore check the tyre inflation pressure at regular intervals.
- ▶ No warning can be given in the event of extreme, sudden tyre damages caused by external factors.
- ▶ The system has not been initialised.
- ▶ When driving on snow-covered or slippery roads.
- ▶ Dynamic driving style: drive wheels slipping, high lateral acceleration.
- ▶ When driving with snow chains.

Wheel change

General

When using a tyre repair kit, it is not always necessary to change a wheel immediately if tyre inflation pressure is lost due to a flat tyre.

If necessary, wheel change tools, such as the vehicle manufacturer's jack, are offered as optional accessories by an authorised Service Partner, or another qualified Service Partner, or a specialist workshop.

Safety information

WARNING

The jack is only intended for raising the vehicle briefly during a wheel change. Even if the safety measures are complied with, there is a risk of the raised vehicle falling over due to the jack slipping. There is a danger of injury or danger to life. If the vehicle is raised with the jack, do not lie underneath the vehicle and do not switch on drive-ready state.

WARNING

Supports such as wooden blocks under the jack can prevent it from achieving its load capacity due to the restricted height. The load capacity of the wooden blocks may be exceeded, causing the vehicle to tip over. There is a danger of injury or danger to life. Do not place supports under the jack.

WARNING

The jack provided by the vehicle manufacturer is intended for changing a wheel in the event of a breakdown. The jack is not designed for frequent use; for example, changing from summer to winter tyres. Using the jack frequently may cause it to become jammed or damaged. There is a danger of injury or material damage. Only use the jack to change an emergency spare wheel or a spare wheel in case of a breakdown.

⚠ WARNING

On soft, uneven or slippery ground, for example, snow, ice, tiles or similar, the jack may slip. There is a danger of injury. Change the wheel on a level, firm and non-slip surface if possible.

⚠ WARNING

The jack is only optimised for raising the vehicle and for use with the jacking points on the vehicle. There is a danger of injury. Do not lift another vehicle or other loads with the jack.

⚠ WARNING

If the jack has not been guided into the jacking point provided, the vehicle might be damaged when the jack is extended, or the jack could slip. There is a danger of injury or material damage. When extending, make sure that the jack is guided into the jacking point adjacent to the wheel arch.

⚠ WARNING

A vehicle raised with a jack can fall from the jack if lateral forces are applied. There is a danger of injury or material damage. If the vehicle is raised, do not apply any lateral forces to the vehicle or pull the vehicle with sudden movements. If the wheel is jammed, have it removed by an authorised Service Partner or another qualified Service Partner or a specialist workshop.

⚠ NOTICE

Using an impact screwdriver to loosen or tighten the locking wheel bolt can damage the bolt. There is a risk of material damage. Only use a wheel bolt wrench to loosen and tighten the locking wheel bolt.

Securing the vehicle against rolling away

General

The vehicle manufacturer recommends that the vehicle should additionally be protected against rolling away during a wheel change.

On a level surface



Place chocks or other suitable objects in front of and behind the wheel diagonally opposite to the one being changed.

On a slight downhill gradient



If it is necessary to change a wheel on a slight downhill gradient, place chocks and other suit-

able objects, for example stones, under the wheels of the front and rear axles against the direction of roll.

Locking wheel bolts

Principle

The locking wheel bolts have a special coding. The bolts can only be released with an adapter that matches the coding.

Overview

The locking wheel bolt adapter is stored on the inside of the boot lid.

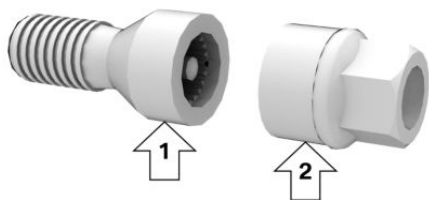

- ▷ Locking wheel bolt, arrow 1.
- ▷ Adapter, arrow 2.

Unscrewing

1. Place the adapter on the locking wheel bolt.
2. Unscrew the locking wheel bolt.
3. After unscrewing the wheel bolt, remove the adapter again.

Screwing in

1. Place the adapter on the locking wheel bolt. If necessary, turn the adapter until it fits on the locking wheel bolt.
2. Screw in the locking wheel bolt. The tightening torque is 140 Nm, 101 lb ft.
3. After screwing in the wheel bolt, remove the adapter again and stow it.

Safety measures

- ▷ Park the vehicle on firm and non-slip ground at a safe distance from traffic.
- ▷ Switch on the hazard warning lights.
- ▷ Apply the parking brake.
- ▷ Engage the steering wheel lock with the wheels in the straight-ahead position.
- ▷ Engage a gear or select selector lever position P.
- ▷ As soon as the traffic flow permits, have all vehicle occupants get out of the vehicle and guide them out of the danger area, for example behind the crash barrier.
- ▷ If necessary, set up the hazard triangle or hazard warning lamp at an appropriate distance.
- ▷ Depending on the equipment, take the wheel change set and, if applicable, the emergency spare wheel out of the vehicle.
- ▷ Additionally secure the vehicle against rolling away.
- ▷ Undo the wheel bolts by half a turn.

Jacking points

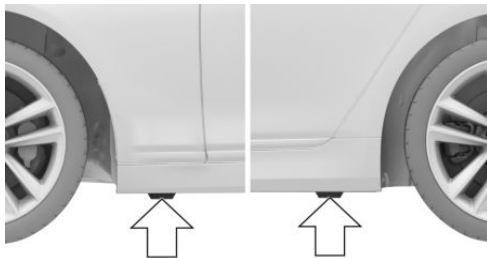

The jacking points are located in the marked positions.

Raising the vehicle

WARNING

Hands or fingers could get trapped when using the jack. There is a danger of injury. Keep your hands in the described position when using the jack, and do not change this position.

1. Hold the jack with one hand, arrow 1, and grasp the jack crank handle or lever with your other hand, arrow 2.

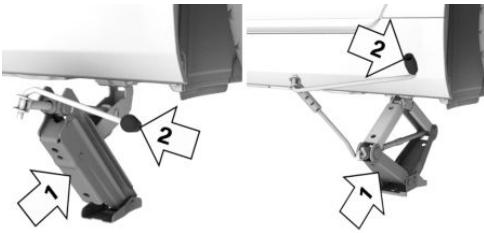

2. Guide the jack into the rectangular recess of the jacking point closest to the wheel to be changed.

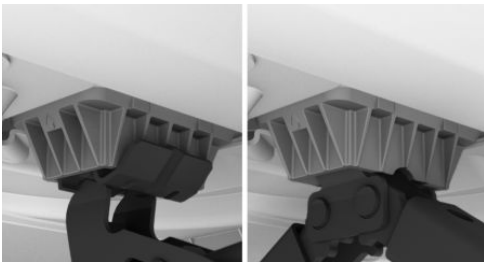

3. Turn the jack crank handle or lever clockwise to extend the jack.



4. Remove your hand from the jack as soon as the jack is under load and continue to turn the jack crank handle or lever with one hand.
5. Make sure that the jack base is extended vertically and at right angles underneath the jacking point.

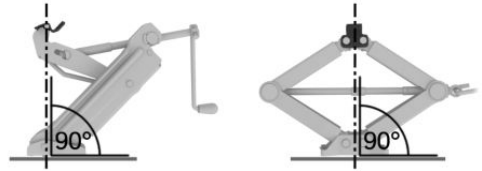

6. Raise by cranking until the surface of the jack stands fully on the ground and the wheel in question is a maximum of 3 cm, 1.2 inches off the ground.

Fitting a wheel

No more than one emergency spare wheel may be fitted.

1. Unscrew the wheel bolts.
2. Remove the wheel.
3. Put on the new wheel or emergency spare wheel and tighten at least two wheel bolts crosswise until finger-tight.

If installing non-original light alloy wheels not supplied by the manufacturer, the

wheel bolts belonging to the wheels may also have to be used.

4. Tighten the remaining wheel bolts until finger-tight and then tighten all the wheel bolts crosswise.
5. Turn the jack crank handle anticlockwise to retract the jack and lower the vehicle.
6. Remove the jack and stow it securely.

After wheel change

1. Tighten the wheel bolts crosswise. The tightening torque is 140 Nm, 101 lb ft.
2. Stow the faulty wheel in the luggage compartment, if necessary.
3. Check tyre inflation pressure at the next opportunity and correct as necessary.
4. Re-initialise the flat tyre monitor or reset the Tyre Pressure Monitor.
5. Check the tight fit of the wheel bolts using a calibrated torque wrench.
6. Drive to the nearest authorised Service Partner or another qualified Service Partner or a specialist workshop to have the damaged tyre replaced.

Emergency spare wheel

Principle

In case of a flat tyre, the emergency spare wheel can be used as a replacement for the defective tyre. The emergency spare wheel is intended for short-term use until the defective wheel has been replaced.

General

Only fit one emergency spare wheel at most. Additionally, regularly check the tyre inflation pressure of the emergency spare wheel in the luggage compartment and correct the pressure if necessary.

Safety information

WARNING

The emergency spare wheel has special dimensions. When driving with an emergency spare wheel, the driving properties may change, for example reduced directional stability when braking, longer braking distance and modified self-steering properties in the limit range. There is a risk of accident. Drive with care and do not exceed a speed of 80 km/h, 50 mph.

Overview

The emergency spare wheel and wheel change set for changing wheels are located in the luggage compartment under the luggage compartment floor.

Removing emergency spare wheel

1. Pull the luggage compartment floor up.
2. Remove the emergency spare wheel and the wheel change set from the storage tray.

Inserting the emergency spare wheel

1. Pull the luggage compartment floor up.
2. Place the emergency spare wheel and the wheel change set in the storage tray.
3. Press the luggage compartment floor downwards.

Engine compartment

Vehicle equipment

This chapter describes equipment, systems and functions which are offered or may be offered in future on a model-specific basis, even

if they are not included in the vehicle in question.

For further information:

Vehicle equipment, see page 8.

Overview

Overview

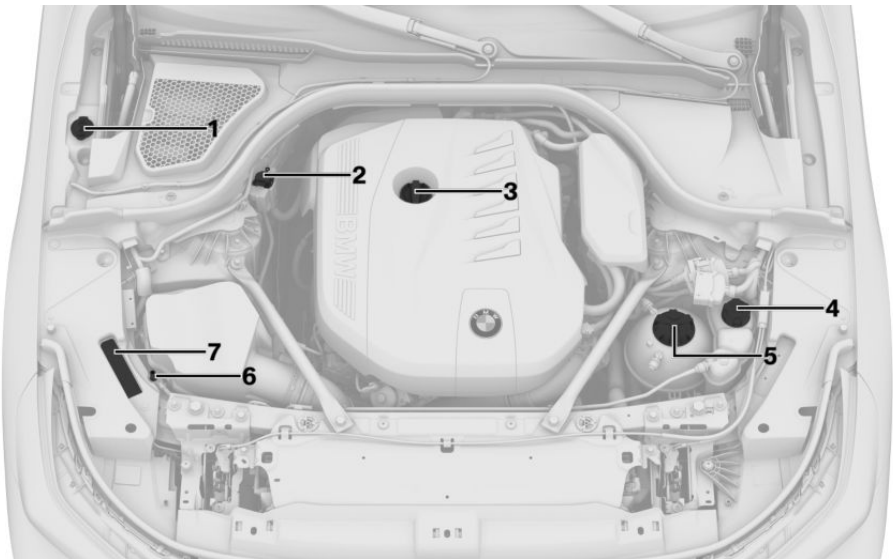

- | | |
|--|--|
| 1 Filler neck for washer fluid | 5 Engine coolant expansion tank |
| 2 Jump start, positive battery terminal | 6 Jump start, negative battery terminal |
| 3 Oil filler neck | 7 Vehicle identification number |
| 4 Additional coolant expansion tank cooling | |

Bonnet

Safety information

WARNING

Incorrectly performed work in the engine compartment can damage components and poses a safety risk. There is a risk of accident or material damage. Have work in the engine compartment carried out by an authorised Service Partner or another qualified Service Partner or a specialist workshop.

WARNING

The engine compartment contains moving components. Certain components in the engine compartment can also move when the vehicle is switched off, for example the radiator fan. There is a danger of injury. Do not reach into an area where there are moving parts. Keep articles of clothing and hair away from moving parts.

WARNING

The bonnet has protruding parts on the inside, for example locking hooks. There is a danger of injury. When the bonnet is open, watch out for protruding parts and keep these areas clear.

WARNING

If the bonnet is not correctly locked, it can come open during the journey and impair visibility. There is a risk of accident. Stop immediately and close the bonnet correctly.

WARNING

Parts of the body can become trapped when opening and closing the bonnet. There is a danger of injury. When opening and closing, make sure that the movement range of the bonnet is kept clear.

NOTICE

Windscreen wipers which are folded away from the windscreen can become trapped if the bonnet is opened. There is a risk of material damage. Before opening the bonnet, make sure that the windscreen wipers are fitted with wiper blades and are in contact with the windscreen.

NOTICE

When closing, the bonnet must lock into place on both sides. Applying additional pressure can damage the bonnet. There is a risk of material damage. Open the bonnet again and close it firmly. Avoid applying additional pressure.

Opening bonnet

The lever for unlocking the bonnet is located behind the footwell trim.

1. Pull the lever, arrow 1.
The bonnet is unlocked.

An acoustic signal and a message on the instrument cluster indicate that the bonnet is open.



2. Release the lever and pull it again, arrow 2. The bonnet can be opened.
3. Watch out for any protruding parts on the bonnet.

Closing the bonnet

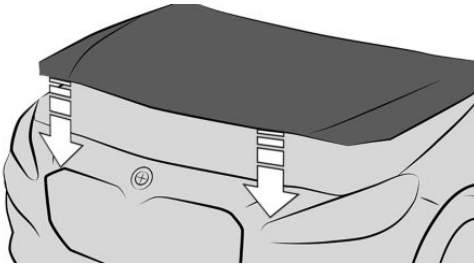

Allow the bonnet to drop from a height of approximately 50 cm, approx. 20 in.

The bonnet must engage on both sides.

Operating fluids

Vehicle equipment

This chapter describes equipment, systems and functions which are offered or may be offered in future on a model-specific basis, even if they are not included in the vehicle in question.

For further information:

Vehicle equipment, see page 8.

Fuel grade

General

Depending on the region, many filling stations sell fuel that is adapted to winter or summer conditions. Fuel that is sold in winter helps with cold starting, for example.

Petrol

General

For optimal fuel consumption, the petrol should be sulphur-free or have a low sulphur content.

Fuels labelled on the pump as containing metal must not be used.

You can fill up with fuels with a maximum ethanol content of 25 %, for example E10 or E25.

The power and consumption specifications refer to operation with RON 98 E10 fuel



The engine has knock control. This means that different petrol grades can be used.

When using fuel of the minimum quality RON 91 or fuel with ethanol content of more than 10 % to a maximum of 25 %, knocking noises as well as driving and acoustic abnormalities may occur. These have no effect on the engine service life.

Safety information

WARNING

The fuel system and engine can be damaged by the wrong fuel, even in small quantities, and by the wrong fuel additives. In addition, the catalytic converter may be permanently damaged. There is a danger of injury or material damage. For petrol engines, do not refuel with or add the following:

- ▷ Leaded petrol.
- ▷ Metallic additives, for example manganese or iron.

After filling with the wrong fuel, do not press the Start/Stop button. Contact an authorised Service Partner or another qualified Service Partner or a specialist workshop.

⚠ NOTICE

Fuel below the specified minimum grade can adversely affect engine function or lead to engine damage. There is a risk of material damage. Do not refuel with fuel below the specified minimum grade.

⚠ NOTICE

Incorrect fuels can damage the fuel system and engine. There is a risk of material damage. Do not refuel with fuel with a higher ethanol content than recommended. Do not refuel with fuel containing methanol, for example M5 to M100.

Petrol grade

The engine is designed to run on petrol complying with DIN EN 228.

Super, RON 95.

Minimum grade

Unleaded petrol, RON 91.

Diesel**General**

The following diesel fuels can be used for refuelling:

- ▶ Diesel fuels with a maximum biodiesel content of 10 %, e.g. B7 or B10.
- ▶ Paraffinic diesel fuels, e.g. XTL.

**Safety information****⚠ WARNING**

The fuel system and engine can be damaged by the wrong fuel, even in small quantities, and by the wrong fuel additives. There is a danger of injury or material damage.

Note the following with diesel engines:

- ▶ Do not fill up with petrol.
- ▶ Observe the minimum quality.
- ▶ Refuel with sulphur-free fuels or fuels with the lowest possible sulphur content.
- ▶ The vehicle manufacturer recommends only using diesel additives and additives that have been classified as suitable.

After filling with the wrong fuel, do not press the Start/Stop button. Contact an authorised Service Partner or another qualified Service Partner or a specialist workshop.

Diesel quality

The engine is designed to run on diesel fuel complying with DIN EN 590 and ASTM D975. Diesel with up to 7 % biodiesel (B7).

Minimum grade

Diesel with up to 10 % biodiesel (B10).
Paraffinic diesel fuel as per EN 15940.

BMW recommends
Shell Quality Fuels 

BMW Diesel with BluePerformance

Principle

BMW Diesel with BluePerformance reduces nitrogen oxides in the diesel exhaust by injecting the reducing agent AdBlue into the exhaust pipe system. In the catalytic converter, this produces a chemical reaction that reduces nitrogen oxides to a minimum.

General

The vehicle has a tank which requires topping up.

There must be a sufficient amount of the reducing agent present in order for drive-ready state to be activated the usual way.

The reducing agent can be topped up at any time.

The reducing agent AdBlue is a registered trademark of the Verband der Automobilindustrie e. V. (VDA).

The reducing agent is available at many service stations.

Preferably top up with reducing agent at a pump dispenser.

Displays on the control display

Displaying filling level and top-up quantity

The filling level and the top-up quantity is shown on the control display.

1. ■■ Apps menu
2. "Vehicle"
3. "Live Vehicle"
4. "Content"
5. "Vehicle status"
6. "AdBlue"

If the filling level is too low, a Check Control message is displayed.

Displays in the instrument cluster

Fuel reserve indicator light

The fuel reserve indicator light in the instrument cluster notifies you if the reducing agent fill level in the tank is low.

Do not allow the reducing agent tank to run completely empty, as otherwise it will not be possible to switch drive-ready state back on after stopping the engine.



A yellow warning light is illuminated in the instrument cluster: filling level too low. The remaining range is shown in the instrument cluster. Top up with at least 5 litres, 1.3 gal of reducing agent immediately.

AdBlue on the minimum level



The reducing agent tank is empty. Immediately top up with at least 15 litres, 4 gal of reducing agent. The engine will continue to run provided that it is not stopped and all other operating conditions are met, for example, there is sufficient fuel.

System fault

If there is a system fault, a Check Control message is displayed.

Visit the nearest authorised Service Partner or another qualified Service Partner or a specialist workshop.

Having AdBlue topped up

BMW recommends having the reducing agent topped up by a Service Partner as part of a regular maintenance schedule.

If you keep to this maintenance schedule, a single top-up is generally required between the maintenance appointments.

As soon as the fuel reserve indicator light is shown in the instrument cluster, have the reducing agent topped up, to avoid problems activating drive-ready state.

Topping up AdBlue yourself

Safety information

WARNING

When the reducing agent container is opened, small quantities of ammonia vapours can emerge. Ammonia vapours have a pungent smell and irritate the skin, mucous membranes and eyes. There is a danger of injury. Do not inhale ammonia vapours. Do not allow reducing agent to come into contact with clothing, skin or eyes, and do not swallow it. Keep children away from reducing agents.

WARNING

Operating fluids, for example oils, greases, coolants and fuels, can contain substances that are harmful to health. There is a danger of injury or danger to life. Please comply with the instructions on the containers. Do not allow operating fluids to come into contact with clothing, skin or eyes. Do not pour operating fluids into other bottles. Keep operating fluids out of the reach of children.

NOTICE

The constituents of the reducing agent are highly aggressive. There is a risk of material damage. Do not allow reducing agent to come into contact with vehicle surfaces.

Suitable AdBlue

AdBlue complying with ISO 22241-1

At many service stations, reducing agent is available at a special pump dispenser. Preferably top up with reducing agent at a pump dispenser.

If no pump dispenser is available, reducing agent can be topped up from a container. Reducing agent is available in various containers. Preferably use the special bottle recommended by BMW. With this bottle and its special adapter, reducing agent can be topped up conveniently.

AdBlue at low temperatures

At outside temperatures below $-11^{\circ}\text{C}/+12^{\circ}\text{F}$, the reducing agent should only be topped up directly before the start of a journey.

Top-up quantity

As soon as the fuel reserve indicator light is displayed, top up at least 5 litres, approx. 1.3 gal.

Displaying the top-up quantity

The top-up quantity is shown on control display.

1.  Apps menu
2. "Vehicle"
3. "Live Vehicle"
4. "Content"
5. "Vehicle status"
6. "AdBlue"

Reducing agent tank

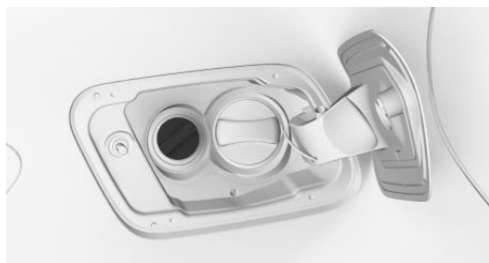

The fuel filler cap for the reducing agent is located next to the fuel filler cap for the fuel tank.

Topping up with reducing agent at the pump dispenser

General

When topping up, hook the fuel pump nozzle fully into the filler pipe. Lifting the fuel pump nozzle while topping up will cause the following to happen:

- ▶ The supply is stopped too soon.
- ▶ Overflow of reducing agent.

The reducing agent tank is full when the fuel pump nozzle cuts out for the first time.

Please comply with the safety regulations displayed at filling stations.

Adding reducing agent

1. Open the fuel filler flap.
Fuel filler cap, see page 346.
2. Turn the reducing agent cap anticlockwise and remove.

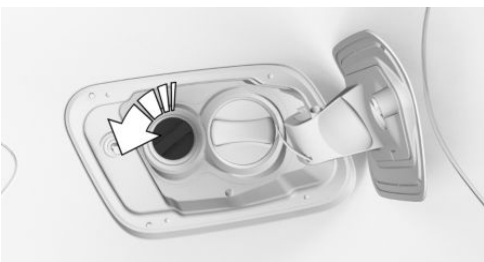

3. Place the fuel filler cap in the holder on the fuel filler flap.

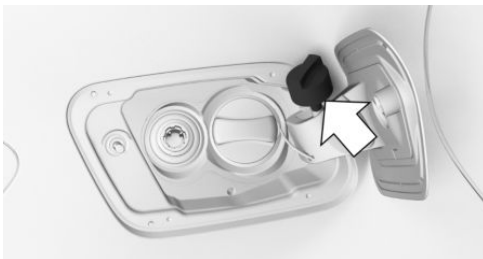

4. Use the fuel pump nozzle to add the recommended top-up quantity as a minimum. The tank is full when the fuel pump nozzle cuts out for the first time.

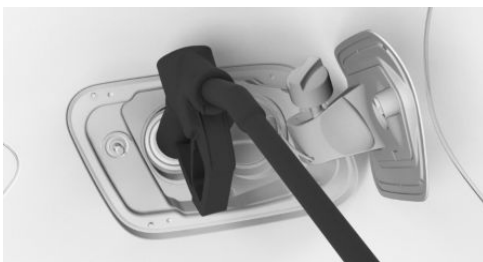

5. Put fuel filler cap on and turn clockwise.
6. Press on the fuel filler flap until it engages.

Filling with an incorrect fluid

General

A Check Control message is displayed if the tank has been filled with the wrong fluid.

If the wrong type of liquid has been added, contact an authorised Service Partner or another qualified Service Partner or a specialist workshop.

Safety information

WARNING

After filling with an incorrect liquid, the system may heat up and catch fire. There is a risk of fire and injury. Only fill with liquids that are intended for the tank. Do not start the engine after filling with an incorrect liquid.

After filling with reducing agent

Fuel reserve indicator light



After topping up, the fuel reserve indicator light continues to be shown with the remaining range.

Drive-ready state can be activated.

After driving for a short time, the fuel reserve indicator light turns off.

AdBlue on the minimum level



After filling up, the display continues to be shown.

Drive-ready state can only be activated when the display is no longer illuminated.

1. Press the Start/Stop button three times.
The display extinguishes after approximately 1 minute.
2. Press the Start/Stop button and switch on drive-ready state.

Engine oil

General

The engine oil consumption and the properties of the engine oil depend on the driving style and operating conditions.

Therefore check the engine oil level regularly each time you fill up with fuel by taking a detailed measurement.

Engine oil consumption may increase due to the following, for example:

- ▷ Dynamic driving style.
- ▷ While running in the engine.
- ▷ Engine idling.
- ▷ Use of engine oil grades rated as unsuitable.

Depending on the engine oil level and properties of the engine oil, different Check Control messages are displayed on the control display.

The manufacturer of the vehicle recommends having the engine oil changed by an authorised Service Partner or another qualified Service Partner or a specialist workshop.

Safety information

NOTICE

Too little engine oil causes engine damage. There is a risk of material damage. Top up with engine oil immediately.

NOTICE

Too much engine oil can damage the engine or the catalytic converter. There is a risk of material damage. Do not add too much engine oil. If there is too much engine oil, have the engine oil level corrected by an authorised Service Partner or another qualified Service Partner or a specialist workshop.

NOTICE

If the engine oil is not changed at the correct time, engine wear may increase which could cause engine damage. There is a risk of material damage. Do not exceed the service date indicated in the vehicle.

Electronic oil measurement

General

Electronic oil measurement uses two measuring procedures:

- ▶ Monitoring.
- ▶ Detailed measurement.

When frequently making short journeys or using a sporty driving style, for example fast cornering, perform a detailed measurement at regular intervals.

Monitoring

Principle

The engine oil level is monitored electronically during the journey and can be shown on the control display.

If the engine oil level is outside its permissible operating range, a Check Control message is shown.

Operating requirements

A current reading is available after approximately 30 minutes of normal driving.

Displaying the engine oil level

1.  Apps menu
2. "Vehicle"
3. "Vehicle status"
4. "Engine oil level"

The engine oil level is displayed.

System limits

When frequently making short journeys or using a sporty driving style, it may not be possible to obtain a measurement. In this case, the measurement for the last, sufficiently long journey is displayed.

Detailed measurement

Principle

The engine oil level is checked when the vehicle is stationary and is shown on a scale.

If the engine oil level is outside its permissible operating range, a Check Control message is shown.

General

During measurement, the idle rotational speed is increased slightly.

Depending on the equipment, an optimum operating range for racing track operation is displayed on the scale.

Operating requirements

- ▶ Vehicle is standing on level ground.
- ▶ Drive-ready state is switched on by pressing the Start/Stop button.
- ▶ Engine is at operating temperature.
- ▶ Selector lever in position N or P and accelerator pedal not pressed.

Carrying out a detailed measurement

1.  Apps menu
2. "Vehicle"
3. "Vehicle status"
4. "Engine oil level"
5. "Oil level measurement"
6. "Start measurement"

The engine oil level is checked and shown on a scale.

Topping up engine oil

General

Do not top up engine oil unless a message is displayed in the instrument cluster. The top-up quantity is specified in the message on the control display.

Only top up with suitable engine oil grades.

Stop the vehicle safely and switch off drive-ready state before topping up with engine oil.

Do not add too much engine oil.

Safety information

WARNING

Operating fluids, for example oils, greases, coolants and fuels, can contain substances that are harmful to health. There is a danger of injury or danger to life. Please comply with the instructions on the containers. Do not allow operating fluids to come into contact with clothing, skin or eyes. Do not pour operating fluids into other bottles. Keep operating fluids out of the reach of children.

NOTICE

Too little engine oil causes engine damage. There is a risk of material damage. Top up with engine oil immediately.

NOTICE

Too much engine oil can damage the engine or the catalytic converter. There is a risk of material damage. Do not add too much engine oil. If there is too much engine oil, have the engine oil level corrected by an authorised Service Partner or another qualified Service Partner or a specialist workshop.

Overview

The oil filler neck is in the engine compartment.

For further information:

Overview, see page 371.

Topping up engine oil

1. Open the bonnet.
Opening, see page 372.
2. Turn the cap anticlockwise to open.



3. Add engine oil.
4. Tighten cap.

Engine oil grades for topping up

General

Engine oil quality is a critical factor in the service life of the engine.

Only top up with the types of engine oil that are listed.

Some engine oil grades may not be available in all countries.

Safety information

NOTICE

Oil additives can damage the engine. There is a risk of material damage. Do not use oil additives.

NOTICE

Using the wrong engine oil can result in engine malfunctions and damage. There is a risk of material damage. When selecting the engine oil, make sure that it is the correct oil specification.

Suitable engine oil grades

Engine oil with the following oil specification can be topped up:

Petrol engine

BMW Longlife-12 FE.

BMW Longlife-17 FE+.

BMW Longlife-22 FE++.

Vehicles without petrol particulate filter: to top up the engine oil, the vehicle manufacturer recommends using an engine oil with the oil specification BMW Longlife-01 FE instead of engine oil with the oil specification BMW Longlife-12 FE.

Diesel engine

BMW Longlife-12 FE.

BMW Longlife-17 FE+.

BMW Longlife-19 FE.

The oil specification BMW Longlife-17 FE is not suitable for use with 40d diesel engines.

BMW Longlife-17 FE+ and BMW Longlife-12 FE are preferred for use with 20d and 23d diesel engines.

Alternative engine oil grades

If suitable engine oils are not available, up to 1 litre, approx. 2 pints, of an engine oil with the following oil specification can be used for topping up:

Petrol engine

ACEA C2.

ACEA C5.

Diesel engine

ACEA C2.

ACEA C5.

The oil specification ACEA C5 is not suitable for the 40d diesel engine.

Viscosity classes

When selecting an engine oil, make sure that the engine oil belongs to one of the following viscosity classes:

Petrol engine

SAE 0W-12.

SAE 0W-20.

SAE 0W-30.

Diesel engine

SAE 0W-20.

SAE 0W-30.

The viscosity class SAE 0W-20 is not suitable for use with 40d diesel engines.

Viscosity classes with a high viscosity grade can increase fuel consumption.

Further information on suitable engine oil specifications and viscosity classes can be obtained from an authorised Service Partner or another qualified Service Partner or a specialist workshop.

**BMW recommends
Original BMW Engine Oil.**

Coolant

General

Coolant is a mixture of water and coolant additive.

Not all commercially available coolant additives are suitable for the vehicle. The vehicle manufacturer recommends using coolant with the BMW LC-18 specification. Do not mix coolant additives of different colours. Comply with the 50:50 mixture ratio of water to coolant additive. Information regarding suitable coolant additives is available from an authorised Service Partner or another qualified Service Partner or a specialist workshop.

Safety information

WARNING

If the cooling system is opened when the engine is hot, coolant can escape and cause scalding. There is a danger of injury. Only open the cooling system when the engine has cooled down.

WARNING

Additives are harmful to health and using the wrong additives can damage the engine. There is a danger of injury or material damage. Do not allow additives to come into con-

tact with clothing, skin or eyes, and do not swallow them. Only use suitable additives.

NOTICE

Excessive water in the coolant reduces its cooling and antifreeze effect. There is a risk of material damage. Comply with the 50:50 mixture ratio of water to coolant additive.

Coolant level

General

On factory delivery, the coolant may be over-filled in the coolant tank. The normal coolant level is achieved by an extended operating time.

The target coolant level is indicated by means of the max. mark in the coolant filler neck of the coolant tank.

For further information:

Overview, see page [371](#).

Checking the coolant level

1. Allow the engine to cool down.
2. Open the bonnet.
Opening, see page [372](#).
3. Turn cap on coolant expansion tank slightly anticlockwise to allow the excess pressure to escape.
4. Open cap on coolant expansion tank.

- The coolant level is correct if it is just below the max. mark in the filler neck.



- Tighten cap.

Disposal



When disposing of coolant and coolant additives, comply with the relevant environmental protection regulations.

Washer fluid

General

All spray nozzles are supplied from one tank. Use a mixture of tap water and screenwash concentrate for the window washer system, if necessary with the antifreeze additive.

Recommended minimum fill quantity: 2 litres/3.5 Imp. pints.

Safety information

WARNING

Some antifreeze additives can contain toxic substances, and are flammable. There is a risk of fire and danger of injury. Please comply with the instructions on the containers. Keep antifreeze additives away from sources of combustion. Do not pour operating fluids into other bottles. Keep operating fluids out of the reach of children.

WARNING

Washer fluid can ignite on contact with hot parts of the engine and catch fire. There is a danger of injury or material damage. Only top up washer fluid when the engine has cooled down. Afterwards fully close the cap of the washer fluid reservoir.

NOTICE

Silicone additives mixed with the washer fluid for their water beading effect on the windows may damage the car wash. There is a risk of material damage. Do not add silicone additives to the washer fluid.

NOTICE

Mixing different screenwash concentrates or antifreeze additives may damage the car wash. There is a risk of material damage. Do not mix different screenwash concentrates or antifreeze additives. Please comply with the instructions and mixing ratios stated on the containers.

Overview



The reservoir for the washer fluid is located in the engine compartment.

Malfunction

Using undiluted screenwash concentrate or antifreeze additive based on alcohol may result in false readings at low temperatures below $-15\text{ }^{\circ}\text{C}$, $+5\text{ }^{\circ}\text{F}$.

Maintenance

Vehicle equipment

This chapter describes equipment, systems and functions which are offered or may be offered in future on a model-specific basis, even if they are not included in the vehicle in question.

For further information:

Vehicle equipment, see page 8.

BMW Maintenance System

Principle

The maintenance system indicates what maintenance measures are required and thereby assists in maintaining the road safety and operational safety of the vehicle.

General

The exact work required and the maintenance intervals may vary depending on the equipment and national-market version. Labour, spare parts, operating materials and wear materials are charged separately. Additional information is available from an authorised Service Partner or another qualified Service Partner or a specialist workshop.

Condition Based Service

Principle

Condition Based Service determines the maintenance requirement using sensors and special algorithms which monitor the conditions in which the vehicle is used.

Necessary maintenance measures are determined based on the individual usage profile.

General

Service notifications can be displayed on the control display.

For further information:

Service notifications, see page 168.

Service data in the vehicle key

Information on maintenance requirement is continuously stored in the vehicle key. The authorised Service Partner can read out this data and suggest appropriate maintenance measures for the vehicle.

Give the service advisor the vehicle key that was last used to drive the vehicle.

Stationary periods

Stationary periods when the vehicle is out of use with its vehicle battery disconnected are not taken into account.

Have any time-dependent maintenance measures, e.g., changing the brake fluid, engine oil, or microfilter/activated carbon filter, performed by an authorised Service Partner or another qualified Service Partner or specialist workshop.

Service history

Maintenance and repairs

Have maintenance and repairs carried out by an authorised Service Partner or another qualified Service Partner or a specialist workshop.

Entries

The maintenance work carried out is entered in the maintenance records and the vehicle data. As with a Service Booklet, the entries serve as proof of regular maintenance.

When data is entered into the vehicle's electronic service history, any service-relevant data is saved both in the vehicle and in the central IT systems of BMW AG, Munich.

After a change of registered keeper, the new owner will be able to view the data entered in the electronic service history. Similarly, an authorised Service Partner or another qualified Service Partner or a specialist workshop can also view the data entered in the electronic service history.

Objection

The registered keeper is entitled to contact an authorised Service Partner or another qualified Service Partner or a specialist workshop and request that no entries are made in the electronic service history and that no data relating to his/her time as owner is subsequently stored in the vehicle or transferred to the vehicle manufacturer. In such cases, no entries will be made in the vehicle's electronic service history.

Displays

Service work which has been logged can be displayed on the control display.

For further information:

Service notifications, see page [168](#).

For Australia: maintenance

No maintenance work other than normal maintenance is required to keep the emission levels of your vehicle within the design limits.

Socket for on-board diagnosis

General

Devices connected to the on-board diagnostic socket trigger the alarm system after locking the vehicle.

Remove devices connected to the on-board diagnostic socket before locking the vehicle.

For further information:

Indicator and warning lights, see page [152](#)

Safety information

NOTICE

Incorrect use of the on-board diagnostic socket can cause malfunctions in the vehicle. There is a risk of material damage. Service and maintenance work involving the on-board diagnostic socket must be carried out by an authorised Service Partner, or another qualified Service Partner, or a specialist workshop, or other authorised persons. Only connect devices that have been tested and found to be safe for use with the socket for on-board diagnosis.

Position



There is an on-board diagnostic socket on the driver's side for reading out vehicle data.



Recycling vehicle

The manufacturer of the vehicle recommends returning the vehicle to a collection point nominated by the manufacturer at the end of its life cycle. The relevant national legal provisions apply to returns and recycling in general. Information on recycling and sustainability can be found on the manufacturer's country-specific websites. Further information is available from an authorised Service Partner or another qualified Service Partner or a specialist workshop.

Replacing parts

Vehicle equipment

This chapter describes equipment, systems and functions which are offered or may be offered in future on a model-specific basis, even if they are not included in the vehicle in question.

For further information:

Vehicle equipment, see page 8.

Toolkit



The toolkit is located in the left storage compartment of the luggage compartment, under a cover.

Wiper blades

Safety information

NOTICE

The windscreen may sustain damage if a windscreen wiper falls onto it without the wiper blade fitted. There is a risk of material damage. Hold the windscreen wiper firmly when changing the wiper blade. Do not fold in or switch on the windscreen wiper without a wiper blade installed.

NOTICE

Windscreen wipers which are folded away from the windscreen can become trapped if the bonnet is opened. There is a risk of material damage. Before opening the bonnet, make sure that the windscreen wipers are fitted with wiper blades and are in contact with the windscreen.

Replacing the wiper blades

1. To replace the wiper blades, move the wipers to the fold-out position.
For fold-out position of the windscreen wipers, see page 182.
2. Fold out the wiper arm and hold firm.
3. Press together securing spring, arrow 1, and fold out the wiper blade, arrow 2.

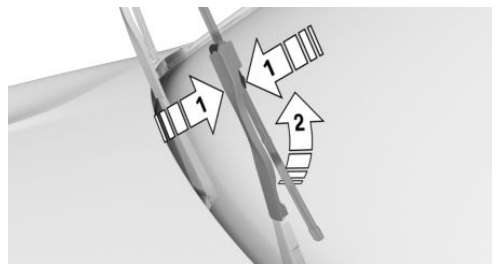

4. Remove the wiper blade forwards out of its catch.
5. Insert the new wiper blade in the opposite sequence ensuring that it clips into place.
6. Fold in the windscreen wipers.

Lights and bulbs

General

Lights and bulbs are an important aspect of driving safety.

All headlights and other lights use at least LED technology.

In the event of a fault, the manufacturer of the vehicle recommends having the relevant work carried out by an authorised Service Partner or another qualified Service Partner or a specialist workshop.

Safety information

WARNING

Intense brightness can irritate or harm the retina of the eye. There is a danger of injury. Do not look directly into the headlights or other light sources. Do not remove covers from LEDs.

Headlight glass

During cool or humid weather, the headlight glass can mist over on the inside. When driving with the lights switched on, the condensation disappears after a short time. There is no need to replace the headlight glass.

If moisture increases, for example if there are water droplets in the lamp despite the headlights being switched on, have the headlights checked.

Vehicle battery

General

The battery is maintenance-free.

More information regarding the battery can be obtained from an authorised Service Partner or

another qualified Service Partner or a specialist workshop.

Safety information

DANGER

Touching live components can result in an electric shock. There is a danger of injury or danger to life. Do not touch any components that could be live.

WARNING

Vehicle batteries that are classified as unsuitable may damage systems or result in functions no longer being carried out. There is a danger of injury or material damage. Only use vehicle batteries that have been classified as suitable by the vehicle manufacturer.

Registering the battery with the vehicle

The manufacturer of the vehicle recommends having an authorised Service Partner or another qualified Service Partner or a specialist workshop register the vehicle battery with the vehicle after the battery has been replaced. Once the battery has been registered again, all comfort functions will be available without restriction and any Check Control messages relating to the comfort functions will no longer be displayed.

Hazard icons

The following hazard icons can be found on the vehicle battery:

Icon	Meaning
	No smoking, no naked flames, no sparks.
	Wear protective goggles.
	Keep away from children.
	Risk of acid burns: wear gloves, do not tilt the battery.
	Rinse any splashes of acid with water immediately. If acid comes into contact with eyes or is swallowed, seek medical attention immediately.
	No direct sunlight, no frost.
	Follow the operating instructions.
	Explosive gas mixture. Do not seal any openings on the battery.

Replacing the battery

General

The manufacturer of the vehicle recommends only having the vehicle battery replaced by an authorised Service Partner or another qualified Service Partner or a specialist workshop. If the battery is not replaced properly, the vehicle may not recognise it properly and perfect functioning cannot be guaranteed.

Notes on removal

Observe the following notes on removing the vehicle battery:

- ▷ Park the vehicle and switch off consumers.
- ▷ First disconnect the power at the negative terminal. Then disconnect the power at the positive terminal.

Notes on installation

Observe the following notes on installing the vehicle battery:

- ▷ Remove any foreign bodies from the battery holder.
- ▷ Only install the battery in the intended position in the vehicle.
- ▷ Keep the battery and vehicle connection contacts clean.
- ▷ First connect the power at the positive terminal. Then connect the power at the negative terminal.
- ▷ Use the connections, connectors and covers provided.
- ▷ Connect a hose to the gas outlet opening if necessary.

Initial operation

The battery is operational. No special precautions are required for start-up.

Charging the battery

General

To ensure the full service life of the battery, keep the battery sufficiently charged.

Charge the battery under the following situations:

- ▷ If the inspection glass on the top of the battery is black.
- ▷ If there is not enough power to start the vehicle.

The following conditions can have a negative effect on battery performance:

- ▷ Frequently driving short distances.
- ▷ If the vehicle is not used for a period of one month or longer.

Safety information

WARNING

Battery chargers that charge the vehicle battery via sockets or cigarette lighters in the vehicle may overload or damage the 12V electrical system. There is a danger of injury or material damage. Only connect battery chargers for the vehicle battery to the starting aid terminals in the engine compartment.

Battery charger

Battery chargers developed especially for the vehicle and suitable for the electrical system can be obtained from an authorised Service Partner or another qualified Service Partner or a specialist workshop.

Charging the battery

Only charge the battery via the starting aid terminals in the engine compartment and with the engine switched off.

Only charge the battery when the bonnet is open.

For further information:

Jump start terminals, see page [400](#).

Open circuit

Following an open circuit, some equipment will have to be reinitialised or individual settings will need to be updated, for example:

- ▷ Parking brake, see page [145](#).
- ▷ With memory function: save positions again.
- ▷ Time: update.
- ▷ Date: update.

Storing the battery

Observe the following information on storing vehicle batteries:

- ▷ Store the battery in a cool and dry place.
- ▷ Protect the battery from direct sunlight and frost.
- ▷ Only clean the battery with a damp, anti-static cloth.
- ▷ Store the battery upright and secure it against falling over.
- ▷ Install the oldest batteries first.
- ▷ Do not remove the protective cap from the contacts.
- ▷ Charge or install the battery by the date on the battery label at the latest. Once fully charged, the battery will work for another 10 months.

Mild hybrid technology

Principle

The vehicle's mild hybrid technology includes a 48 volt battery. Mild hybrid technology can reduce fuel consumption.

Safety information

DANGER

Touching live components can result in an electric shock. There is a danger of injury or danger to life. Do not touch any components that could be live.

Notice

Do not replace or work on the mild hybrid technology battery.

Disposing of the old battery



Dispose of old batteries with an authorised Service Partner, another qualified Service Partner or a specialist work-

shop, or hand them in to an authorised collection point.

Batteries filled with acid should be transported upright. Protect batteries against falling over when in transit.

Warranty

See the vehicle purchase contract for information on the battery warranty.

Fuses

General

The fuses are located at different positions in the vehicle.

Information on fuse assignment, as well as the positions of the fuse boxes, is available on the Internet: fusecard.bmw.com.

Safety information

WARNING

Incorrect or repaired fuses can overload electrical cables and components. There is a risk of fire. Do not repair blown fuses or replace them with fuses with a different colour or amp rating.

Replacing fuses

The vehicle manufacturer recommends having fuses changed by an authorised Service Partner or another qualified Service Partner or a specialist workshop.

Help in case of a breakdown

Vehicle equipment

This chapter describes equipment, systems and functions which are offered or may be offered in future on a model-specific basis, even if they are not included in the vehicle in question.

For further information:

Vehicle equipment, see page 8.

Hazard warning lights

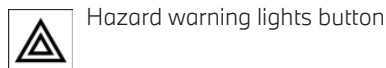
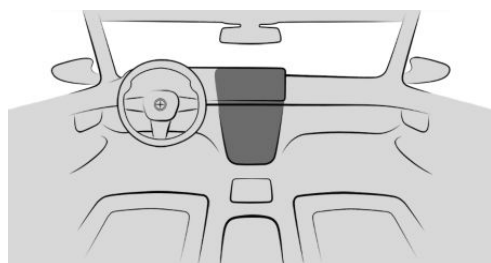

Hazard warning lights button

The red light in the button flashes when the hazard warning lights are turned on.

Warning triangle

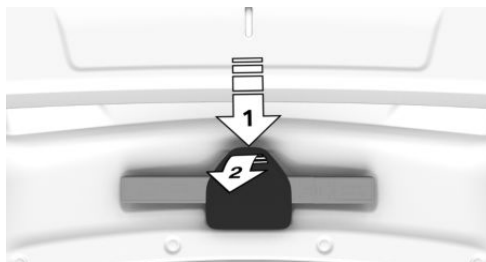

The warning triangle is housed on the inside of the boot lid.

Press the unlocking mechanism, arrow 1, and swivel the cover down, arrow 2.

First-aid kit

General

Depending on the equipment and the national-market version, the vehicle may have a first-aid kit.

Some items in the kit have a limited life.

Check the use-by dates of the contents regularly and replace any items that have expired in good time.

Storage

The first-aid kit is housed in the luggage compartment.

BMW Assistance

Principle

In the event of a breakdown or accident, or for questions about the vehicle, BMW Assistance

can be used to contact the BMW Group customer support.

General

This feature depends on the vehicle equipment and national-market version.

For more information on this service, the vehicle manufacturer recommends contacting an authorised Service Partner or the hotline/customer support.

Starting service

1.  Apps menu
2. "All apps"
3. "BMW Assistance"
4. "BMW Assistance"

Voice contact to customer support is established.

BMW Emergency Service

Principle

BMW Group Roadside Assistance can be contacted if assistance is needed in the event of a breakdown.

General

In the event of a breakdown, data on the vehicle's condition is sent to BMW Roadside Assistance.

It is possible that malfunctions can be remedied directly.

There are various ways of contacting BMW Roadside Assistance:

- ▶ Via supplementary text messages in the Check Control message.
- ▶ By calling with a mobile phone.
- ▶ Via the BMW app.

Depending on the national-market version and vehicle type, a different roadside assistance

provider can be assigned via the ConnectedDrive Customer Portal if necessary.

Operating requirements

- ▶ Active ConnectedDrive contract, equipment with intelligent emergency call or BMW ConnectedDrive services.
- ▶ Mobile reception.
- ▶ Standby state is switched on.

Starting BMW Roadside Assistance manually

When equipped with Teleservices, support is provided first through Teleservice Diagnosis and then by Teleservice help if required.

1.  Apps menu
2. "All apps"
3. "BMW Assistance"
4. "BMW Roadside Assistance" or select the desired service.

Follow the displays on the control display. A voice contact is established.

Teleservice Diagnosis

Teleservice Diagnostics enables detailed vehicle data, which is necessary for vehicle diagnosis, to be transmitted via mobile communication. This data is transferred automatically. It may be necessary to approve this on the Control Display.

Teleservice Assistance

Teleservice Assistance is a country-specific feature that allows BMW Roadside Assistance to carry out a more in-depth diagnosis of the vehicle via mobile radio.

Teleservice Assistance can be started after a request by BMW Roadside Assistance.

1. Park the vehicle safely.
2. Apply the parking brake.

3. Turn on control display.
4. Consent to Teleservice help.

BMW Accident Assistance

Principle

BMW Group Accident Assistance can be contacted if assistance is needed in the event of an accident.

General

If the vehicle sensors detect a minor to moderately severe accident that did not trigger any airbags, a Check Control message is displayed in the instrument cluster. A corresponding text message also appears on the control display.

When BMW Accident Assistance is activated, data on the vehicle's condition is transferred to BMW.

Depending on the national-market version and vehicle type, a different accident assistance provider can be assigned via the ConnectedDrive Customer Portal if necessary.

Operating requirements

- ▶ Active ConnectedDrive contract, equipment with intelligent emergency call or BMW ConnectedDrive services.
- ▶ Mobile reception.
- ▶ Standby state is switched on.

Starting BMW Accident Assistance

If an accident is detected automatically

A BMW Accident Assistance text message is shown on the control display.

The connection can be established directly: "Contact accident assistance"

For a short time, the Check Control message for BMW Accident Assistance can also be

retrieved from the saved Check Control messages.

For further information:

Check Control, see page 151.

Starting BMW Accident Assistance manually

BMW Accident Assistance can also be contacted independently of the automatic accident detection function.

1.  Apps menu
2. "All apps"
3. "BMW Assistance"
4. "BMW Accident Assistance" or select the desired service.

Follow the displays on the control display. A voice contact is established.

Emergency call

Statutory emergency call

Principle

The system can be used to trigger an emergency call automatically or manually in emergency situations.

General

Depending on the equipment and the national-market version, the vehicle may have an emergency call system.

Press the SOS button in the headliner only in an emergency.

The emergency call establishes a connection to a public emergency call number.

This depends on factors such as the specific mobile communications network and national regulations, among others.

The emergency call is placed using the integrated SIM card in the vehicle and cannot be switched off.

For technical reasons, it might not be possible to make an emergency call in highly adverse conditions.

Overview

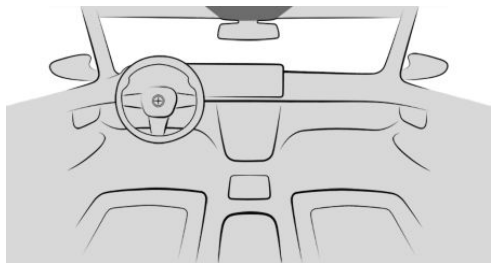

 The SOS button is located in the headliner.

Operating requirements

- ▶ Standby state is switched on.
- ▶ Emergency call system is functional.
- ▶ Integrated SIM card in the vehicle is activated.

Automatic triggering

Under certain conditions, e.g. if the airbags are deployed, an emergency call is triggered automatically immediately after an accident of appropriate severity. Pressing the SOS button does not affect the automatic emergency call.

Manual triggering

1. Tap the cover flap.
 2. Press and hold the SOS button until the LED in the button area is illuminated green.
- ▶ The LED is illuminated green when the emergency call has been activated.
- If a cancellation request is shown on the control display, the emergency call can be cancelled.

If the situation permits, wait in the vehicle until voice contact has been established.

- ▶ The LED flashes green when the connection to the emergency call has been established.

When an emergency call is made, data is sent to the public rescue coordination centre in order to decide what rescue measures are required, for example the position of the vehicle, if this can be determined.

For information on data transfer and storage:

Statutory emergency call system, see page 16.

Even if the vehicle occupants can no longer hear the rescue coordination centre through the loudspeakers, the rescue coordination centre can still hear the vehicle occupants speak.

The rescue coordination centre ends the emergency call.

Malfunction

The emergency call function may be impaired. The LED in the area of the SOS button flashes for approximately 30 seconds. A Check Control message is shown.

Have it checked by an authorised Service Partner or another qualified Service Partner or a specialist workshop.

Intelligent emergency call

Principle

The system can be used to trigger an emergency call automatically or manually in emergency situations.

General

Depending on the equipment and the national-market version, the vehicle may have an emergency call system.

Press the SOS button in the headliner only in an emergency.

The intelligent emergency call system establishes a connection with the BMW emergency call centre.

Even if no emergency call through BMW is possible, in some cases an emergency call may still be established to a public emergency call number. This depends on factors such as the specific mobile phone network and national regulations, among others.

For technical reasons, it might not be possible to make an emergency call in highly adverse conditions.

Overview



 The SOS button is located in the headliner.

Operating requirements

- ▶ Standby state is switched on.
- ▶ Emergency call system is functional.
- ▶ Integrated SIM card in the vehicle is activated.

Automatic triggering

Under certain conditions, e.g. if the airbags are deployed, an emergency call is triggered automatically immediately after an accident of appropriate severity. Pressing the SOS button does not affect the automatic emergency call.

Manual triggering

1. Tap the cover flap.
2. Press and hold the SOS button until the LED in the button area is illuminated green.

- ▶ The LED is illuminated green when the emergency call has been activated.

If a cancellation request is shown on the control display, the emergency call can be cancelled.

If the situation permits, wait in the vehicle until voice contact has been established.

- ▶ The LED flashes green when the connection to the emergency call has been established.

When an emergency call is made through BMW, data such as the vehicle's current position, if this can be determined, is sent to the emergency call centre in order to decide what rescue measures are required.

If questions asked by the emergency call centre remain unanswered, rescue measures are implemented automatically.

Even if the vehicle occupants can no longer hear the emergency call centre through the loudspeakers, the emergency call centre can still hear the vehicle occupants speak.

The emergency call centre ends the emergency call.

Malfunction

The emergency call function may be impaired.

The LED in the area of the SOS button flashes for approximately 30 seconds. A Check Control message is shown.

Have it checked by an authorised Service Partner or another qualified Service Partner or a specialist workshop.

Fire extinguisher

Principle

The fire extinguisher can be used to put out vehicle fires.

General

Depending on the equipment and the national-market version, the vehicle may have a fire extinguisher.

Safety information

WARNING

Incorrect use of the fire extinguisher can cause injury. There is a danger of injury. Observe the information below when using the fire extinguisher:

- ▷ Do not inhale the extinguishing agent. If the extinguishing agent has been inhaled, move the affected person into fresh air. If the casualty experiences breathing difficulties, contact a doctor immediately.
- ▷ Do not allow the extinguishing agent to come into contact with the skin. Prolonged contact with the extinguishing agent can cause the skin to dry out.
- ▷ Do not allow the extinguishing agent to come into contact with the eyes. In the event of contact with the eyes, rinse them immediately with plenty of water. In case of prolonged discomfort, contact a doctor.

WARNING

Objects in the driver's footwell can restrict the pedal travel or block a pedal that has been pressed. There is a risk of accident. Ensure that items in the vehicle are stowed securely and cannot get into the driver's footwell.

Overview

The fire extinguisher is located in the interior, for example under the seat or in the glove compartment.

Removing the fire extinguisher

Open the buckles on the retaining strap.

Using the fire extinguisher

To use the fire extinguisher, follow the manufacturer's instructions on the fire extinguisher and the information supplied with it.

Stowing the fire extinguisher

1. Insert the fire extinguisher into the holder.
2. Hook in and close the buckles.

Maintenance and refilling

Have the fire extinguisher checked every 2 years by an authorised Service Partner or another qualified Service Partner or a specialist workshop.

Make a note of the next maintenance date for the fire extinguisher.

Replace the fire extinguisher after use or have it refilled.

Jump start

General

If the vehicle battery is discharged, the engine can be started from another vehicle's battery using two jump leads. Only use jump leads with fully insulated terminal clamps.

Safety information

DANGER

Touching live components can result in an electric shock. There is a danger of injury or danger to life. Do not touch any components that could be live.

WARNING

Connecting the jump lead in the wrong sequence can cause sparks. There is a danger of injury. Please comply with the correct sequence when connecting.

WARNING

Contact between the bodywork of the two vehicles when jump-starting can cause a short circuit. There is a danger of injury or material damage. Make sure there is no contact between vehicle bodies.

Preparations

1. Check whether the battery in the other vehicle shows 12V voltage. Information about the voltage is provided on the battery.
2. Switch off the engine of the donor vehicle.
3. Switch off any power consumers in both vehicles.

Jump start terminals

The starting aid terminals are located in the engine compartment.

For further information:

Overview, see page [371](#).

Open the lid of the starting aid terminals.

Connecting the cables

Before starting, switch off all unnecessary power consumers, for example the radio, on both vehicles.

1. Open the cover of the jump start terminal.
2. Connect a terminal clamp of the positive/+ jump lead to the positive battery terminal or the corresponding jump start terminal on the donor vehicle.
3. Connect the second terminal clamp to the positive battery terminal or to the corresponding jump start terminal on the vehicle being started.
4. Connect a terminal clamp of the negative/- jump lead to the negative battery terminal or the corresponding engine or body ground on the donor vehicle.
5. Connect the second terminal clamp to the negative battery terminal or to a corresponding engine or body ground on the vehicle being started.

Starting the engine

Never use spray products to start the engine.

1. Start the engine of the donor vehicle and allow it to run for a few minutes at a slightly higher idle rotational speed.
If starting a vehicle with diesel engine: allow the engine of the donor vehicle to run for approximately 10 minutes.
2. Start the engine of the vehicle to be started in the usual way.
If an initial start attempt fails, wait a few minutes before trying again to allow the discharged battery to recharge.
3. Allow both engines to run for a few minutes.
4. Disconnect the jump leads in reverse order to connection.

Check the battery and have it recharged if necessary.

Tow-starting/towing away

Safety information

WARNING

Individual functions may malfunction when tow-starting or towing away with activated front collision warning or Cruise Control switched on. There is a risk of accident. Turn off the front collision warning and Cruise Control before tow-starting or towing away.

Steptronic transmission: transporting the vehicle

General

The vehicle must not be towed for transport.

Safety information

NOTICE

If the vehicle is towed away with one axle raised, the vehicle can be damaged. There is a risk of material damage. Only have the vehicle transported on a loading platform.

WARNING

The vehicle may be damaged when raising and securing it.

There is a danger of injury or material damage.

- ▷ Use suitable equipment to raise the vehicle.
- ▷ Do not raise or secure the vehicle by its towing eye, body parts or suspension parts.

Pushing the vehicle

To remove a broken-down vehicle from a danger area, it can be pushed over a short distance at a maximum speed of 10 km/h, 6 mph.

For further information:

For rolling or pushing the vehicle, see page 137.

Recovery vehicle

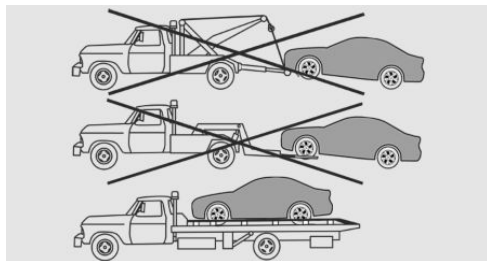

Only have the vehicle transported on a loading platform.

Towing other vehicles

General

Switch on the hazard warning lights in line with local regulations.

If the electrical system of the vehicle being towed has failed, the vehicle must be made identifiable to other road users, for example by placing a sign or the warning triangle in the rear window.

Safety information

WARNING

If the permitted total weight of the towing vehicle is less than that of the vehicle being towed, the towing eye may be torn off or it may not be possible to control the vehicle. There is a risk of accident. Make sure that the

total weight of the towing vehicle is greater than the weight of the vehicle being towed.

WARNING

Different levels of braking may occur during tow-starting/towing away with adaptive recuperation. There is a risk of accident. Deactivate adaptive recuperation before tow-starting/towing away.

NOTICE

If the towbar or the towing rope is not attached correctly, other vehicle parts can be damaged. There is a risk of material damage. Attach the towbar or towing rope to the towing eye correctly.

Towbar

The towing eyes of both vehicles should be on the same side.

If it is impossible to avoid attaching the towbar at an angle, note the following:

- ▶ Clearance may be restricted when cornering.
- ▶ Lateral force will be generated if the towbar is installed at an angle.

Towing rope

Note the following if using a towing rope:

- ▶ Use nylon ropes or straps that will allow the vehicle to be towed smoothly.
- ▶ Fasten the towing rope so it is not twisted.
- ▶ Check the towing eye and towing rope fastening regularly.
- ▶ Do not exceed a towing speed of 50 km/h, 30 mph.

- ▶ Do not exceed a towing distance of 5 km, 3 miles.
- ▶ Ensure that the towing rope is taut when the towing vehicle drives off.

Towing eye

General



Always keep the screw-on towing eye in the vehicle.

The towing eye can be screwed in at the front or rear of the vehicle.

The towing eye is located in the toolkit.

Observe the following notes when using the towing eye:

- ▶ Only use the towing eye supplied with the vehicle.
- ▶ Turn the towing eye at least 5 turns clockwise and screw it in tight and as far as it will go. If necessary, tighten with a suitable object.
- ▶ After use, unscrew the towing eye in an anti-clockwise direction.
- ▶ Only use the towing eye for towing on paved roads.
- ▶ Avoid transverse loads on the towing eye, for example do not raise the vehicle by the towing eye.
- ▶ Check the towing eye mounting regularly.

For further information:

Toolkit, see page [389](#).

Safety information

NOTICE

If the towing eye is not used as intended, the vehicle or towing eye may be damaged. There is a risk of material damage. Observe the notes on using the towing eye.

Thread for towing eye



Press the marking on the edge of the cover to press it out.

Tow-starting

Do not attempt to tow-start the vehicle.

If necessary, start the engine using the jump start.

Have the cause of the starting problems rectified by an authorised Service Partner or another qualified Service Partner or a specialist workshop.

For further information:

Jump start, see page [399](#).

Care

Vehicle equipment

This chapter describes equipment, systems and functions which are offered or may be offered in future on a model-specific basis, even if they are not included in the vehicle in question.

For further information:

Vehicle equipment, see page 8.

Vehicle wash

General

Regularly remove foreign objects, for example, leaves or snow, in the area below the windscreen.

Wash the vehicle frequently, especially in winter. Heavy soiling and road salt can cause damage to the vehicle.

For further information:

For fold-out position of the windscreen wipers, see page 182.

Safety information

NOTICE

Damages may occur if the fuel filler flap is open while washing. There is a risk of material damage. Close the fuel filler flap before washing. Remove any dirt behind the fuel filler flap with a cloth.

High-pressure cleaners

Safety information

NOTICE

When cleaning with high-pressure cleaners, excessive pressure or excessive temperatures can damage various components. There is a risk of material damage. Maintain a sufficient distance and do not spray for an extended period of time. Comply with the instructions for the high-pressure cleaner.

Distances and temperature

- ▷ Maximum temperature: 60 °C, 140 °F.
- ▷ Minimum distance to sensors, cameras, seals, and lights: 30 cm, approx. 12 in.
- ▷ Minimum distance to the glass sunroof: 80 cm, 31.5 in.

Automatic car washes

Safety information

NOTICE

The vehicle can be damaged if automatic car washes are used incorrectly. There is a risk of material damage. Observe the following notes:

- ▷ Textile car washes or systems using soft brushes are preferable, to avoid damage to the paintwork.
- ▷ Do not drive into delete car washes or washing bays with guide rails higher than 10 cm, 4 in, to avoid damage to the body.

- ▷ Note the maximum tyre width of the guide rail to avoid damage to tyres and rims.
- ▷ Fold in the exterior mirrors to avoid damaging them.
- ▷ Deactivate the windscreen wipers and the rain sensor (if fitted) to avoid damage to the wiper system.

Entering a car wash

NOTICE

The selector lever position P is automatically engaged when standby state is switched off. The wheels are locked. There is a risk of material damage. Do not switch off standby state if the vehicle is to roll, e.g. in conveyor car washes.

The vehicle must be able to roll freely while in the car wash.

Some car washes require you to leave the vehicle. It is not possible to lock the vehicle from the outside in selector lever position N. If an attempt is made to lock the vehicle, a signal sounds.

For further information:

For rolling or pushing the vehicle, see page 137.

Exiting from a car wash

Make sure that the vehicle key is in the vehicle.

Switch on drive-ready state.

For further information:

Drive-ready state, see page 49.

Lights

Do not rub wet lights dry, and do not use abrasive, alcohol-based, or corrosive cleaning agents.

Soak impurities, for example insect residues, with shampoo and wash off with water.

Remove ice with a de-icer spray; do not use an ice scraper.

After vehicle wash

After vehicle wash, briefly apply the brakes to dry them, otherwise braking effect may be temporarily reduced. The heat generated by braking dries the brake discs and brake pads and protects them against corrosion.

Completely remove residues on the windcreens to avoid affecting visibility due to smearing and to reduce wiping noise and wiper blade wear.

Vehicle care

Care products

General

BMW recommends using care and cleaning products from BMW. Suitable care products are available from an authorised Service Partner or another qualified Service Partner or a specialist workshop.

Safety information

WARNING

Cleaning agents can contain hazardous substances or pose a health risk. There is a danger of injury. When cleaning the interior, open the doors or windows. Use only products that are intended for vehicle cleaning. Observe the notes on the packaging.

Vehicle paintwork

General

Regular care promotes driving safety and preserves your vehicle's value. Environmental effects in areas with high air pollution or natural contaminants, for example tree resin or pollen,

may affect the vehicle paintwork. Take such factors into consideration when deciding on the frequency and scope of vehicle care measures.

Immediately remove aggressive substances, such as spilled fuel, oil, grease, or bird droppings, to prevent the paintwork from being damaged and discoloured.

Matt paintwork

Only use cleaning and care products that are suitable for vehicles with matt paintwork.

Leather care

Remove dust from the leather at regular intervals with a cloth or vacuum cleaner.

Dust and road dirt will otherwise become worked into pores and folds, resulting in considerable abrasion and causing the leather surface to become prematurely brittle.

To protect against discolouration, for example from clothing, clean and care for the leather approximately every two months.

Clean light-coloured leather more frequently as it has the tendency to soil faster.

Use leather cleaner, otherwise dirt and grease will attack the protective coating of the leather.

Immediately remove aggressive substances, such as sunscreen, to prevent the leather from being altered or discoloured.

Synthetic leather care

Clean the synthetic leather regularly with a damp microfibre cloth or vacuum cleaner.

Dust and road dirt will otherwise become worked into pores and folds, resulting in considerable abrasion and causing the surface to become prematurely brittle.

In case of major contaminations, use a moist soft sponge or microfibre cloth with suitable interior cleaners.

Immediately remove aggressive substances, such as sunscreen, to prevent the synthetic leather from being altered or discoloured.

Fabric care

General

In case of major contaminations, such as beverage stains, use a moist soft sponge or microfibre cloth with suitable interior cleaners.

Immediately remove aggressive substances, such as sunscreen, to prevent the fabric from being altered or discoloured.

Safety information

NOTICE

Open hook and loop fasteners on articles of clothing can damage the seat covers and other cloth upholstery in the vehicle. There is a risk of material damage. Make sure that the hook and loop fasteners are closed.

Care of upholstery fabrics

Vacuum regularly with a vacuum cleaner.

Clean extensively down to the seams. Avoid rubbing vigorously.

Textile care

Use a microfibre cloth for cleaning minor contamination.

Dampen the cloth with water.

Care of special parts

Displays, operating elements and protective glass of the Head-up display

NOTICE

The surfaces can be damaged by improper cleaning, e.g. with chemical cleaners, moisture or liquids of all kinds. There is a risk of material damage.

- ▷ Avoid applying excessive pressure and do not use abrasive materials.
- ▷ Use a dry, clean anti-static microfibre cloth for cleaning displays.
- ▷ Clean the operating elements and, depending on the equipment, clean the protective glass of the Head-up display using a damp microfibre cloth and commercially available dish-washing soap.

Light alloy wheels

When cleaning the wheels while they are installed on the vehicle, only use neutral rim cleaner with a pH value between 5 and 9. Do not use abrasive cleaners or high-pressure cleaners above 60 °C, 140 °F. Observe the manufacturer's instructions.

Corrosive, acidic or alkaline cleaners may destroy the protective coatings of adjacent parts, for example brake disc.

After cleaning, briefly apply the brakes to dry them. The heat generated by braking dries the brake discs and brake pads and protects them against corrosion.

Chrome-like surfaces

Chrome-like surfaces, particularly those that have been exposed to road salt, should be cleaned carefully with plenty of water, with added shampoo if required.

Rubber parts

The surfaces of rubber parts can be contaminated or lose their shine due to environmental influences. Only use water and suitable care products for cleaning.

Rubber parts subjected to high wear and tear should be treated regularly with rubber care products. Do not use silicone-based care products for treating rubber seals, otherwise these could be damaged and become a source of noise.

Wiper blades

The wiper blades are cleaned by using the window washer system.

Avoid additional manual cleaning of the wiper blades to prevent a reduction in wipe quality.

Fine wood parts

Clean fine wood trim and fine wood parts with a damp cloth. Then dry with a soft cloth.

Kenaf

Treat parts made from kenaf fibres with a suitable care product only.

Plastic parts

NOTICE

Cleaning agents containing alcohol or solvents, for example nitro thinners, cold cleaners, fuel or similar can damage plastic parts. There is a risk of material damage. Clean with a microfibre cloth. Lightly moisten the cloth with water if necessary.

Do not soak the headliner.

Seat belts

WARNING

Chemical cleaners can destroy the fabric of the seat belts, causing the seat belts to become ineffective and unable to protect occupants. There is a danger of injury or danger to life. Only use a mild soap and water solution for cleaning the seat belts.

Dirt on the seat belt straps can interfere with the action of the reel and is a safety hazard.

Only clean the seat belt straps with a mild soap solution while still fitted to the vehicle.

Do not allow seat belts to retract until they are dry.

Carpets and floor mats

WARNING

Objects in the driver's footwell can restrict the pedal travel or block a pedal that has been pressed. There is a risk of accident. Ensure that items in the vehicle are stowed securely and cannot get into the driver's footwell. Only use floor mats that are suitable for the vehicle and can be securely fastened to the floor. Do not use loose floor mats, and do not place several floor mats on top of one another. Make sure that there is sufficient space for the pedals. Ensure that floor mats are securely reattached after removal, for example for cleaning.

Floor mats can be removed from the vehicle to enable the interior to be cleaned more thoroughly.

In the event of heavy soiling, clean floor carpets using a microfibre cloth and water or textile cleaner. Rub back and forth in the direction of travel to prevent matting.

Sensors and camera lenses

Cleaning the front camera and Reversing Assist Camera

Cleaning of the front camera and Reversing Assist Camera is offered on the control display if dirt is detected or can be switched on manually.

1.  Apps menu
2. "Vehicle"
3. "Parking"
4. "More"
5. "Camera cleaning"
6. Select the desired setting.

Laying up the vehicle

Special measures need to be taken if putting the vehicle out of use for longer than three months. Additional information is available from an authorised Service Partner or another qualified Service Partner or a specialist workshop.

Technical data

Vehicle equipment

This chapter describes equipment, systems and functions which are offered or may be offered in future on a model-specific basis, even

if they are not included in the vehicle in question.

For further information:
Vehicle equipment, see page 8.

General

The technical data and specifications in the Owner's Handbook are reference figures. Data relating to a specific vehicle can deviate from this, for example, due to selected optional equipment, national-market versions or country-specific measurement procedures. Detailed values can be found in the permit documents,

on signs on the vehicle or can be requested from an authorised Service Partner or another qualified Service Partner or a specialist workshop.

The information in the vehicle documents always takes precedence over the information in the Owner's Handbook.

Payload

The payload stated in the Owner's Handbook refers to a vehicle without a driver with standard equipment and does not take into account any optional equipment. Optional equipment can change the actual weight of the vehicle and generally increases it. This also changes

the payload and generally reduces it. The actual payload depends on the actual weight and the technically permissible gross weight and must be determined on a vehicle-by-vehicle basis.

Dimensions

Dimensions can vary depending on the model version, equipment or country-specific measurement method.

The vehicle height may also deviate, e.g. as a result of tyres and load.

BMW 5 Series Saloon

Width with mirrors	mm (in)	2156 (84.9)
Width without mirrors	mm (in)	1900 (74.8)
Height	mm (in)	1515 (59.6)
Length	mm (in)	5060 (199.2)

BMW 5 Series Saloon

Wheelbase	mm (in)	2995 (117.9)
Turning circle diameter	m (ft)	12.4 (40.7)

Weights

BMW 520i Saloon

Kerb mass ready for use, with 75 kg load, tank 90 % full, no optional equipment	kg (lb)	1800 (3968)
Permitted total mass	kg (lb)	2335 (5148)
Payload	kg (lb)	610 (1345)
Front axle load limit	kg (lb)	1165 (2568)
Rear axle load limit	kg (lb)	1320 (2910)

BMW 520d Saloon

Kerb mass ready for use, with 75 kg load, tank 90 % full, no optional equipment	kg (lb)	1850 (4079)
Permitted total mass	kg (lb)	2405 (5302)
Payload	kg (lb)	630 (1389)
Front axle load limit	kg (lb)	1165 (2568)
Rear axle load limit	kg (lb)	1360 (2998)

BMW 520d xDrive Saloon

Kerb mass ready for use, with 75 kg load, tank 90 % full, no optional equipment	kg (lb)	1905 (4200)
Permitted total mass	kg (lb)	2460 (5423)
Payload	kg (lb)	630 (1389)
Front axle load limit	kg (lb)	1210 (2668)
Rear axle load limit	kg (lb)	1360 (2998)

Trailer operation

BMW 520i Saloon

Trailer loads according to EU operating licence. Consult an authorised Service Partner or another qualified Service Partner or a specialist workshop about options for increasing the loads.

Trailer load without brake	kg (lb)	750 (1653)
Trailer load with brake on upward gradient up to 12 %	kg (lb)	2000 (4409)
Trailer load with brake on upward gradient up to 8 %	kg (lb)	2000 (4409)
Maximum trailer nose weight	kg (lb)	100 (220)
Minimum trailer nose weight	kg (lb)	25 (55)
Rear axle load limit, towing vehicle	kg (lb)	1450 (3197)
Permitted total mass, towing vehicle	kg (lb)	2435 (5368)

BMW 520d Saloon

Trailer loads according to EU operating licence. Consult an authorised Service Partner or another qualified Service Partner or a specialist workshop about options for increasing the loads.

Trailer load without brake	kg (lb)	750 (1653)
Trailer load with brake on upward gradient up to 12 %	kg (lb)	2000 (4409)
Trailer load with brake on upward gradient up to 8 %	kg (lb)	2000 (4409)
Maximum trailer nose weight	kg (lb)	100 (220)
Minimum trailer nose weight	kg (lb)	25 (55)
Rear axle load limit, towing vehicle	kg (lb)	1490 (3285)
Permitted total mass, towing vehicle	kg (lb)	2505 (5523)

BMW 520d xDrive Saloon

Trailer loads according to EU operating licence. Consult an authorised Service Partner or another qualified Service Partner or a specialist workshop about options for increasing the loads.

Trailer load without brake	kg (lb)	750 (1653)
----------------------------	---------	------------

BMW 520d xDrive Saloon

Trailer load with brake on upward gradient up to 12 %	kg (lb)	2000 (4409)
Trailer load with brake on upward gradient up to 8 %	kg (lb)	2000 (4409)
Maximum trailer nose weight	kg (lb)	100 (220)
Minimum trailer nose weight	kg (lb)	25 (55)
Rear axle load limit, towing vehicle	kg (lb)	1490 (3285)
Permitted total mass, towing vehicle	kg (lb)	2560 (5644)

Mounting points of the trailer tow hitch

The specifications for the mounting points refer to the vehicle's zero point. The overhang specification refers to the rear axle. Further information can be obtained from an authorised Service Partner or another qualified Service Partner or a specialist workshop.

		Length	Width	Height
Mounting point 1	mm (in)	3827 (150.7)	-471 (-18.5)	210 (8.3)
Mounting point 2	mm (in)	3827 (150.7)	471 (18.5)	210 (8.3)
Mounting point 3	mm (in)	3827 (150.7)	-471 (-18.5)	91 (3.6)
Mounting point 4	mm (in)	3827 (150.7)	471 (18.5)	91 (3.6)
Maximum permissible overhang of rear coupling point	mm (in)	1195 (47)	—	—

Capacities

BMW 5 Series

Fuel tank, approx.	Litres (gal)	60.0 (13.2)
--------------------	--------------	-------------

Please observe the additional information about fuel grade, see page [374](#).

Seats for child restraint systems

Vehicle equipment

This chapter describes equipment, systems and functions which are offered or may be offered in future on a model-specific basis, even if they are not included in the vehicle in question.

For further information:

Vehicle equipment, see page 8.

Information for manufacturers of child seats

General

Information about which child restraint systems can be used on each seat, in accordance with the ECE-R 16 and ECE-R 129 standards.

Left-hand drive vehicles: Suitability of child restraint systems for each vehicle seat

Seat position	1	3 – Airbag ON forward facing	3 – Airbag OFF – a) rearward facing	4	5	6
Seat position suitable for universal fastening with a belt.	No	Yes	Yes	Yes	Yes	Yes
i-Size seat position.	No	No	No	Yes	No	Yes
Seat position suitable for side mounting: L1/L2.	No	No	No	Yes	No	Yes
Largest rear-facing mounting: R1/R2X/R2/R3.	No	No	No	R3	No	R3
Largest front-facing mounting: F2X/F2/F3.	No	No	No	F3	No	F3
Largest suitable booster mount: B2/B3.	No	B3	No	B3	B3	B3

A seat position without i-Size approval is not compatible with an i-Size support stand.

A seat position with lower ISOFIX anchors, but with no top tether, is not available.

There are no seat belt buckles for adults between the two bottom ISOFIX anchors.

a) Deactivation of the front passenger airbag is possible depending on the equipment or national-market version.

Seat number	Position in the vehicle
1	Front left
2	Front centre

Seat number	Position in the vehicle
3	Front right
4	Second-row seating left

Seat number	Position in the vehicle
5	Second-row seating centre
6	Second-row seating right
7	Third-row seating left

Seat number	Position in the vehicle
8	Third-row seating centre
9	Third-row seating right

Right-hand drive vehicles: suitability of child restraint systems for each vehicle seat

Seat position	1 – Airbag ON	1 – Airbag OFF – a)	3	4	5	6
Seat position suitable for universal fastening with a belt.	Yes	Yes	No	Yes	Yes	Yes
	forward facing	rearward facing				
i-Size seat position.	No	No	No	Yes	No	Yes
Seat position suitable for side mounting: L1/L2.	No	No	No	Yes	No	Yes
Largest rear-facing mounting: R1/R2X/R2/R3.	No	No	No	R3	No	R3
Largest front-facing mounting: F2X/F2/F3.	No	No	No	F3	No	F3
Largest suitable booster mount: B2/B3.	B3	No	No	B3	B3	B3

A seat position without i-Size approval is not compatible with an i-Size support stand.

A seat position with lower ISOFIX anchors, but with no top tether, is not available.

There are no seat belt buckles for adults between the two bottom ISOFIX anchors.

a) Deactivation of the front passenger airbag is possible depending on the equipment or national-market version.

Seat number	Position in the vehicle
1	Front left
2	Front centre
3	Front right
4	Second-row seating left
5	Second-row seating centre
6	Second-row seating right
7	Third-row seating left

Seat number	Position in the vehicle
8	Third-row seating centre
9	Third-row seating right

Appendix

General

Here is where any updates to the Owner's Handbook for the vehicle are listed.

Updates after going to press

After the Integrated Owner's Handbook in the vehicle went to press, the following chapters were updated in the printed Owner's Handbook:

- ▶ Operation: Seats, mirrors and steering wheel: Front seats: Calibration of front seats: Calibrating front seats.
- ▶ Operation: Seats, mirrors and steering wheel: Seat belts: Safety function.
- ▶ Operation: Safety: Active Protection: Function.

License Texts and Certifications

Argentina

Basis Central Platform



Lear
H-28860

Australia

Basis Central Platform



Botswana

Basis Central Platform

Lear



BOCRA: 2023/8051

Brazil

Basis Central Platform



Lear

CODE: 02071-23-04767

Comfort Access

Brazil Este equipamento não tem direito à proteção contra interferência prejudicial e não pode causar interferência em sistemas devidamente autorizados. Para mais informações, consulte o site da ANATEL – <https://www.gov.br/anatel/pt-br>.

Brunei

Basis Central Platform

Lear



China

HeadUnit

本设备包含型号为 MGU22, 核准代码为 CMIIT ID: 2022DJ10152 的无线电发射设备

Directive 2014/53/EU

Comfort Access

Hereby, Brose Fahrzeugteile SE & Co. KG declares that HFA is in compliance with Directive 2014/53/EU. The full text of the EU declaration of conformity is available at the following internet address: <https://www.brose.com/de-de/produkte/ce-bmw-r-hfa-gen1.html>

Frequency Band: 77GHz – 79GHz

Maximum Output Power: 16,9dBm EIRP

Manufacturer address:

Brose Fahrzeugteile SE & Co. KG

Berliner Ring 1, 96052 Bamberg, Germany

Eurasian Economic Union

Basis Central Platform



Ghana

Basis Central Platform

Lear

NCA APPROVED: 7E6-M1-219-SRD

Israel

Basis Central Platform

Lear

51-89371

מספר אישור אלחוטני של משרד התקשורת הוא
 אסור להחליף את האנטנה המקורית של המכשיר ולא
 לעשות בו כל שינוי טכני אחר

Jamaica

Basis Central Platform

Lear: This product has been Type Approved by Jamaica: SMA – "Equipment Identifier"

Japan

Comfort Access

Japanese Radio Law and Japanese Telecommunications Business Law Compliance. This device is granted pursuant to the Japanese Radio Law () and the Japanese Telecommunications Business Law (). This device should not be modified (otherwise the granted designation number will become invalid).

Japan

HeadUnit

当該無線設備の送信は、自動車内においてのみ可能
 Transmission of the radio equipment is possible only in the car.

Malaysia

Basis Central Platform



Lear

HIDF15000195

Mexico

Basis Central Platform

Lear

IFT: BMLEBC23-02853



Comfort Access

This product contains an IFETEL No. Xxxx

Moldova

Basis Central Platform

Lear



Oman

Basis Central Platform

Lear

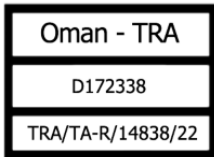

Approved by PTA

TAC NO : 9.481/2022

Paraguay

Basis Central Platform



Pakistan

Basis Central Platform

Lear



Lear

NR: 2022-11-I-0739

Philippines

Basis Central Platform

Lear



HeadUnit

Garmin

ESD-RCE-2232030

Serbia

Basis Central Platform

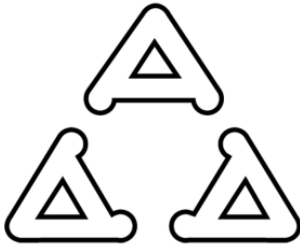

Lear

South Africa

Basis Central Platform

Lear



TA-2022/3191

South Korea

Basis Central Platform

Lear



R-R-Ler-BCP-01

Taiwan

Basis Central Platform

Lear



本產品符合低功率電波輻射性電機管理辦法第十二條、第十四條等條文規定

1. 經型式認證合格之低功率射頻電機，非經許可，公司、商號或使用者均不。得擅自變更頻率、加大功率或變更原設計之特性及功能
2. 低功率射頻電機之使用不得影響飛航安全及干擾合法通信；經發現有干擾。現象時，應立即停用，並改善至無干擾時方得繼續使用。前項合法通信，指依電信法規定作業之無線電通信低功率射頻電機須忍受合法通信或工業、科學及醫療用電波輻射性電機設。備之干擾

Thailand

Basis Central Platform

Lear

"เครื่องโทรคมนาคมและอุปกรณ์นี้มีความสอดคล้องตามมาตรฐานหรือข้อกำหนดทางเทคนิคของ กสทช."

This telecommunication equipment conforms to the technical standards or requirements of NBTC.

Comfort Access

Whoever possess or use this radio-communication equipment or set up radio-communication station shall receive license from license officer. In case of violation of section 6 or 11, will be subject to penalty as per section 23 of Radio-communication Act B.E. 2498.

UAE

Basis Central Platform

Lear

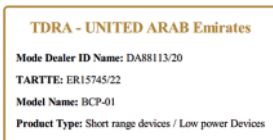

US FCC

Comfort Access

NOTICE: Changes or modifications made to this equipment not expressly approved by

Brose Fahrzeugteile SE & Co. KG may void the FCC authorization to operate this equipment.

Vietnam

Basis Central Platform

Lear



Zambia

Basis Central Platform

Lear



ZMB/ZICTA/TA/2023/2/12

Everything from A to Z

Index

0-9

- 3D view [267](#)
- 48V technology, see Mild hybrid technology [392](#)

A

- ABS, see Anti-lock Braking System [223](#)
- Acceleration assistant, see Launch Control [139](#)
- Acceleration sensor, see G-Meter [165](#)
- Accessories and parts [10](#)
- Accident Assistance, see BMW Accident Assistance [396](#)
- Accident prevention, see Active Protection [219](#)
- Acoustic pedestrian protection [133](#)
- Activated carbon filter, see Interior filter [301](#)
- Activation, airbag [186](#)
- Activation points, Panorama View [269](#)
- Activation, trailer operation [334](#)
- Activation word [60](#)
- Active bonnet, see Active pedestrian protection [187](#)
- Active Cruise Control, Distance Control, see Cruise Control Systems [231](#)
- Active Guard, refer to Collision warning systems [188](#)
- Active Park Distance Control [275](#)
- Active pedestrian protection [187](#)
- Active Protection [219](#)
- Active seat ventilation [299](#)
- Active steering, integral [226](#)
- Adaptive brake light, see Dynamic brake lights [216](#)
- Adaptive Headlights [176](#)
- Adaptive lighting functions [176](#)
- Adaptive recuperation [340](#)
- Adaptive suspension [290](#)
- Adaptive suspension Professional [290](#)
- AdBlue at low temperatures [377](#)

- AdBlue at minimum [376](#)
- AdBlue, see BMW diesel with BluePerformance [376](#)
- AdBlue, topping up [376](#)
- Additional camera views [263](#)
- Additives, engine oil grades [381](#)
- Adjusting driving dynamics, see My Modes [141](#)
- Adjust speed to route [255](#)
- After-run of fan, see Exhaust gas particulate filter [325](#)
- Airbags [184](#)
- Airbags, warning light [186](#)
- Air conditioning function, climate control [296](#)
- Air distribution, manual [295](#)
- Air flow, automatic air conditioning [295](#)
- Air pressure, tyres [348](#)
- Air quality [301](#)
- Air recirculation function [297](#)
- Air vents, see Ventilation [300](#)
- Alarm, avoiding [101](#)
- Alarm system [100](#)
- All-season tyres, see Winter tyres [353](#)
- All-season tyres, tread [350](#)
- All-wheel drive, see BMW xDrive [225](#)
- Alternating-code hand-held transmitter [307](#)
- Amazon Alexa Car Integration [64](#)
- Ambient lighting [179](#)
- Android Auto, see Owner's Handbook for Navigation, Entertainment, Communication [6](#)
- Anticipation, Speed Limit Info [229](#)
- Antifreeze additive, see Washer fluid [384](#)
- Antifreeze protection, see Washer fluid [384](#)
- Anti-lock Braking System [223](#)
- Anti-theft security system, locking wheel bolts [368](#)
- Anti-trap mechanism, windows [103](#)
- Apple CarPlay, see Owner's Handbook for Navigation, Entertainment, Communication [6](#)
- Applications, see Owner's Handbook for Navigation, Entertainment, Communication [6](#)

- Apps, see Owner's Handbook for Navigation, Entertainment, Communication [6](#)
- Aquaplaning [326](#)
- Artificial engine noise, see Acoustic protection for pedestrians [133](#)
- Assistance, BMW [394](#)
- Assisted Driving Mode Plus, see Cruise Control Systems [231](#)
- Assisted Driving Mode, tracking, see Cruise Control Systems [231](#)
- Assisted View [165](#)
- Attachment point of wireless systems [326](#)
- Attention Assistant [220](#)
- Attention camera, driver, see Driver Attention Camera [221](#)
- Audioplayer, see Owner's Handbook for Navigation, Entertainment, Communication [6](#)
- Audio, see Owner's Handbook for Navigation, Entertainment, Communication [6](#)
- AUTO H button, see Automatic Hold [146](#)
- Automatic air conditioning [291](#)
- Automatic camera perspective [266](#)
- Automatic car washes [404](#)
- Automatic dimming, see High-beam Assistant [171](#)
- Automatic driving lights [173](#)
- Automatic driving lights control [173](#)
- Automatic Hold [146](#)
- Automatic locking [99](#)
- Automatic parking function, exterior mirrors [118](#)
- Automatic programme, automatic air conditioning [293](#)
- Automatic rear air conditioning system [291](#)
- Automatic Start/Stop function [133](#)
- Automatic time setting [165](#)
- Automatic transmission, see Steptronic transmission [136](#)
- Automatic unlocking [99](#)
- Automating habits, BMW Intelligent Personal Assistant [64](#)
- AUTO programme, automatic air conditioning [293](#)
- Average consumption, see Trip data [163](#)
- Avoiding false alarms [101](#)
- Axle loads, permitted [411](#)
- ## B
- Backrest angle [108](#)
- Backrest contour, see Lumbar support [109](#)
- Backrest, seats [106](#)
- Backrest width [109](#)
- Bad weather light [177](#)
- Ball head, electrically adjustable [331](#)
- Bar for tow-starting/towing away [402](#)
- Battery, disposal [392](#)
- Battery, vehicle [390](#)
- Belts, see Seat belts [110](#)
- Biodiesel [375](#)
- Black ice, see Outside temperature [162](#)
- Blower, see Amount of air [295](#)
- Bluetooth audio, see Owner's Handbook for Navigation, Entertainment, Communication [6](#)
- Bluetooth connection, see Owner's Handbook for Navigation, Entertainment, Communication [6](#)
- BMW Accident Assistance [396](#)
- BMW app, see Owner's Handbook for Navigation, Entertainment, Communication [6](#)
- BMW Assistance, see Owner's Handbook for Navigation, Entertainment, Communication [6](#)
- BMW Curved Display [55](#)
- BMW diesel with BluePerformance [376](#)
- BMW Digital Key [94](#)
- BMW Drive Recorder [216](#)
- BMW gesture control [65](#)
- BMW IconicSounds [290](#)
- BMW ID [75](#)
- BMW iDrive [51](#)
- BMW Intelligent Personal Assistant [60](#)
- BMW Live Cockpit Plus, see BMW Curved Display [55](#)
- BMW Live Cockpit Professional, see BMW Curved Display [55](#)
- BMW Maintenance System [386](#)
- BMW Natural Interaction, see BMW gesture control [65](#)
- BMW Operating System, see BMW iDrive [51](#)
- BMW Roadside Assistance [395](#)
- BMW Services, see Owner's Handbook for Navigation, Entertainment, Communication [6](#)

BMW SIM Reader, see Owner's Handbook for Navigation, Entertainment, Communication [6](#)
 BMW Theatre Screen, see Owner's Manual for Navigation, Entertainment, Communication [6](#)
 BMW xDrive [225](#)
 Bonnet [371](#)
 Boost, see Sport Boost function [140](#)
 Boot lid, emergency release [92](#)
 Bottle holder, front, see Cup holder, front [316](#)
 Bottle holder, rear, see Cup holder, rear [317](#)
 Brake Assist [223](#)
 Brake discs, see Brake system [324](#)
 Brake light, adaptive, see Dynamic brake lights [216](#)
 Brake lights, dynamic [216](#)
 Brake pads, see Brake system [324](#)
 Brake system [324](#)
 Braking, notes [327](#)
 Braking safely [327](#)
 Breakdown, help [394](#)
 Break recommendation, see Attentiveness Assistant [220](#)
 Brightness, control display [56](#)
 Buckling angle, Trailer Assistant [335](#)
 Button, central locking system [97](#)
 Buttons on the steering wheel [38](#)
 Button SOS, see Intelligent emergency call [397](#)
 Button SOS, see Legal emergency call [396](#)
 Button, start/stop [133](#)

C

Calibration of the front seats [109](#)
 Camera cleaning [408](#)
 Camera, instrument cluster, see Driver Attention Camera [221](#)
 Camera lenses, care [408](#)
 Camera perspective, automatic [266](#)
 Camera perspective, semi-automatic [266](#)
 Camera, Reversing Assist Camera [265](#)
 Camera, see Sensors in the vehicle [42](#)
 Camera view assistance lines [263](#)
 Can holder, front, see Cup holder, front [316](#)
 Can holder, rear, see Cup holder, rear [317](#)
 Care [404](#)
 Care, displays, screens [407](#)

Care, head-up display [407](#)
 Care, light-alloy wheels [407](#)
 Care of upholstery fabrics [406](#)
 Care products [405](#)
 Care, vehicle [405](#)
 Car key, see Vehicle key [80](#)
 Carpet, care [408](#)
 Carrying children [122](#)
 Carrying children safely [122](#)
 Car wash [404](#)
 Car washes, automatic [404](#)
 Car wash view [268](#)
 Catalytic converter, see Hot exhaust system [325](#)
 CBS, see Condition Based Service [386](#)
 Central airbag [185](#)
 Central display, see Control display [55](#)
 Central indication range, instrument cluster [162](#)
 Central key, see Vehicle key [80](#)
 Central locking switch, see Central locking system [97](#)
 Central locking system [97](#)
 Centre airbag, see Central airbag [185](#)
 Centre armrest, front [316](#)
 Centre console [40](#)
 Changes, technical, see Own safety [9](#)
 Change, wheels and tyres [351](#)
 Changing bulbs, see Lights and bulbs [390](#)
 Changing the battery, vehicle key [81](#)
 Charging a smartphone, see Wireless charging tray [310](#)
 Charging cradle for smartphones, see Wireless charging tray [310](#)
 Chassis number, see Vehicle identification number [20](#)
 Check Control [151](#)
 Checking tyre pressure, see Tyre Pressure Monitor [358](#)
 Child locks [132](#)
 Child restraint systems, i-Size [125](#)
 Child restraint systems, see Carrying children safely [122](#)
 Child safety seat fasteners, ISOFIX [125](#)
 Child seat classes, see Suitable seats for child restraint systems [128](#)
 Child seat installation [123](#)

- Child seats, see Carrying children safely [122](#)
- Chrome-like surfaces, care [407](#)
- Chrome-plated surfaces, care [407](#)
- Cleaning, see Care [405](#)
- Climate comfort windscreen [326](#)
- Climate control [291](#)
- Closing with a smartphone, see BMW Digital Key [94](#)
- Closing with the Key Card [92](#)
- Coasting [341](#)
- Coasting in idle [341](#)
- Coat hooks [317](#)
- Cold start, see Engine start [49](#)
- Collision Warning, see Front collision warning [190](#)
- Collision warning systems [188](#)
- Comfort Access [87](#)
- Communication, see Owner's Handbook for Navigation, Entertainment, Communication [6](#)
- Compact wheel, see Emergency spare wheel [370](#)
- Compartments in the doors [315](#)
- Compressor [354](#)
- Concierge Service, see BMW Assistance [394](#)
- Condensation when vehicle is parked [328](#)
- Condition Based Service [386](#)
- ConnectedDrive, see Owner's Handbook for Navigation, Entertainment, Communication [6](#)
- ConnectedDrive Services, see Owner's Handbook for Navigation, Entertainment, Communication [6](#)
- ConnectedMusic, see Owner's Handbook for Navigation, Entertainment, Communication [6](#)
- Connecting electrical devices, see Sockets [308](#)
- Connecting, mobile devices [67](#)
- Connecting mobile devices to the vehicle [67](#)
- Consumption, see Trip data [163](#)
- Contactless operation of boot lid [91](#)
- Contacts, see Owner's Handbook for Navigation, Entertainment, Communication [6](#)
- Continuing driving with flat tyre, see Flat tyre monitor, checking tyre pressure, see Flat tyre monitor [364](#)
- Continuing driving with flat tyre, see Tyre Pressure Monitor [358](#)
- Control display [55](#)
- Controller [56](#)
- Control systems, driving stability [223](#)
- Conveyor car wash [404](#)
- Coolant [383](#)
- Coolant level [383](#)
- Coolant temperature, see Engine temperature [161](#)
- Cooling, maximum [296](#)
- Cornering light [177](#)
- Corrosion, brake discs [328](#)
- Coupling angle, Trailer Assistant [335](#)
- Crossing-traffic warning [214](#)
- Crossroads Warning, see Front collision warning [190](#)
- Cruise Control, see Cruise Control systems [231](#)
- Cruise Control Systems [231](#)
- Cup holder, front [316](#)
- Cup holder, rear [317](#)
- Current driving condition [167](#)
- Curved Display [55](#)
- Customer support [394](#)
- ## D
- Damages, tyres [350](#)
- Dashboard, see Instrument cluster [148](#)
- Dashcam, see BMW Drive Recorder [216](#)
- Data protection, settings [74](#)
- Data, see Deleting personal data [74](#)
- Data storage medium, see Vehicle data and data protection [10](#)
- Data, technical [410](#)
- Date [165](#)
- Day, see Date [165](#)
- Daytime driving lights [175](#)
- Deactivation, airbag [186](#)
- Deep sleep mode [48](#)
- Defrosting [298](#)
- Defrosting windscreen [298](#)
- De-icing, windscreen [298](#)
- Deleting, personal data [74](#)
- Departure schedule, see Pre-cooling/pre-heating [301](#)
- Departure time, pre-conditioning via Remote Engine Start [304](#)
- Departure time, pre-heating [302](#)

- Destination entry, see Owner's Handbook for Navigation, Entertainment, Communication [6](#)
- Detecting traffic lights [258](#)
- Diagnostic connection [387](#)
- Diesel fuel [375](#)
- Diesel particulate filter, see Exhaust gas particulate filter [325](#)
- Digital Key, see BMW Digital Key [94](#)
- Digit input, iDrive [53](#)
- Dimensions [410](#)
- Dimming exterior mirror [118](#)
- Dimming interior mirror [118](#)
- Direct dial buttons, see Shortcuts [54](#)
- Direction indicator, see Turn indicator [170](#)
- Display and operating concept, see BMW iDrive [51](#)
- Display, iDrive [53](#)
- Displaying information on driver assistance, see Assisted View [165](#)
- Displaying information on parking assistance, see Assisted View [165](#)
- Display lighting, see Instrument lighting [178](#)
- Display panel, see Instrument cluster [148](#)
- Displays [148](#)
- Displays and icons [7](#)
- Display, see BMW Curved Display [55](#)
- Display, see Control display [55](#)
- Displays for the vehicle, see Live Vehicle [149](#)
- Disposal, coolant [384](#)
- Disposal, vehicle battery [392](#)
- Disposing of the old battery [392](#)
- Distance Control, see Cruise Control Systems [231](#)
- Distance to vehicle ahead, see Cruise Control Systems [231](#)
- Distance warning, see Park Distance Control [272](#)
- Door handle lighting, see Welcome light [174](#)
- Door opening angle [270](#)
- Downhill gradient [327](#)
- Drinks holder, front, see Cup holder, front [316](#)
- Drinks holder, rear, see Cup holder, rear [317](#)
- Drive mode Efficient, see My Modes [141](#)
- Drive mode Personal, see My Modes [141](#)
- Drive mode Sport, see My Modes [141](#)
- Drive-off Assistant, see Dynamic Stability Control [223](#)
- Drive off monitoring [276](#)
- Drive-off support [225](#)
- Drive power reduced [160](#)
- Driver activity, see Driver Attention Camera [221](#)
- Driver assistance, parking, see Parking assistance systems [260](#)
- Driver assistance systems [227](#)
- Driver Attention Camera [221](#)
- Drive-ready state, see Operating condition of the vehicle [47](#)
- Drive Recorder [216](#)
- Driver profiles [75](#)
- Driver profiles, welcome display [75](#)
- Drive sound, see BMW IconicSounds [290](#)
- Driving [133](#)
- Driving Assistant, refer to Collision warning systems [188](#)
- Driving comfort [290](#)
- Driving condition, display [167](#)
- Driving dynamics, setting [224](#)
- Driving Experience Control, see My Modes [141](#)
- Driving hints, see General driving notes [325](#)
- Driving lane lines, additional displays camera views [263](#)
- Driving lights control, automatic [173](#)
- Driving notes [324](#)
- Driving off, see Drive-off support [225](#)
- Driving Stability Control Systems [223](#)
- Driving, Start/Stop button [133](#)
- Driving through water [326](#)
- Drying air, see Air conditioning function [296](#)
- DSC, see Dynamic Stability Control [223](#)
- DTC, see Setting for increased driving dynamics [224](#)
- Dynamic brake lights [216](#)
- Dynamic damping, see Adaptive suspension [290](#)
- Dynamic ECO light function [176](#)
- Dynamic Stability Control [223](#)
- Dynamic Traction Control, see Setting for increased driving dynamics [224](#)

E

- ECO light function, dynamic [176](#)
- Efficiency Coach, Efficient Mode [342](#)
- Efficient coasting, see Current driving condition [167](#)
- Efficient drive mode [342](#)
- Efficient mode [342](#)
- Efficient Mode, see My Modes [141](#)
- Electronic oil measurement [380](#)
- Electronic Stability Programme ESP, see Dynamic Stability Control [223](#)
- Emergency assistance, see BMW Accident Assistance [396](#)
- Emergency assistance, see BMW Roadside Assistance [395](#)
- Emergency brake, see Emergency Stop Assistant [213](#)
- Emergency braking, see PostCrash – iBrake [220](#)
- Emergency call [396](#)
- Emergency Lane Assistant [247](#)
- Emergency release, boot lid [92](#)
- Emergency release, fuel filler flap [347](#)
- Emergency release, transmission lock [138](#)
- Emergency service, see BMW Accident Assistance [396](#)
- Emergency service, see BMW Roadside Assistance [395](#)
- Emergency spare wheel [370](#)
- Emergency Stop Assistant [213](#)
- Engine, automatic start-stop function [133](#)
- Engine compartment [371](#)
- Engine coolant [383](#)
- Engine cooling system [383](#)
- Engine idling when driving, see Coasting [341](#)
- Engine noise, artificial, see Acoustic protection for pedestrians [133](#)
- Engine oil filler neck [381](#)
- Engine oil grades for topping up [381](#)
- Engine oil level, checking electronically [380](#)
- Engine oil, topping up [381](#)
- Engine sound, see BMW IconicSounds [290](#)
- Engine start, see Drive-ready state [49](#)
- Engine start, see Jump start [399](#)
- Engine stop, see Drive-ready state [49](#)
- Engine temperature [161](#)
- Entering an address, Navigation, see Owner's Handbook for Navigation, Entertainment, Communication [6](#)
- Entering letters and numbers [53](#)
- Entertainment, see Owner's Handbook for Navigation, Entertainment, Communication [6](#)
- Entertainment, selection list in the instrument cluster [159](#)
- Equipment, interior [306](#)
- eSIM Telephony, see Owner's Manual for Navigation, Entertainment, Communication [6](#)
- ESP Electronic Stability Programme, see Dynamic Stability Control [223](#)
- Evasion Assistant, see Front collision warning [190](#)
- Event data recorder [20](#)
- Exchange, wheels and tyres [351](#)
- Exhaust gas particulate filter [325](#)
- Exhaust, see Exhaust system [325](#)
- Exhaust system [325](#)
- Exit warning [199](#)
- Exterior lights, locked vehicle [174](#)
- Exterior mirror camera, see Sensors in the vehicle [42](#)
- Exterior mirrors [117](#)
- Exterior mirrors, automatic parking function [118](#)
- External start, see Jump start [399](#)
- Eye for securing cable, trailer operation [333](#)
- Eye for towing [402](#)
- Eyes, see Lashing eye in the luggage compartment [319](#)

F

- Factory settings, see Vehicle data, resetting [75](#)
- Failure message, see Check Control [151](#)
- False alarm, see Avoiding false alarms [101](#)
- Fan run-on, see Exhaust gas particulate filter [325](#)
- Fastening seat belts, see Seat belts [110](#)
- Fatigue Warning, see Attention Assistance [220](#)
- Fault displays, see Check Control [151](#)
- Filling pressure, tyres [348](#)
- Filter, see Interior filter [301](#)

Fine wood parts, care [407](#)
 Fire extinguisher [399](#)
 First-aid kit [394](#)
 Flank view [267](#)
 Flat tyre, continue driving, see Flat tyre monitor [364](#)
 Flat tyre, fixing [353](#)
 Flat tyre message, see Flat Tyre Monitor [365](#)
 Flat tyre message, see Tyre Pressure Monitor [362](#)
 Flat tyre monitor [364](#)
 Flat tyre, see Flat tyre monitor [364](#)
 Flat tyre, see Tyre Pressure Monitor [358](#)
 Flat tyre warning light, see Flat Tyre Monitor [365](#)
 Flat tyre warning light, see Tyre Pressure Monitor [362](#)
 Flat tyre, wheel change [366](#)
 Flood, driving through [326](#)
 Floor carpet, care [408](#)
 Floor mats, care [408](#)
 Fogging, windscreen [298](#)
 Fold-out position, windscreen wiper [182](#)
 Foot brake [327](#)
 Front airbags [184](#)
 Front camera, see Sensors in the vehicle [42](#)
 Front collision warning [190](#)
 Front passenger's mirror, tilting down, see Automatic parking function [118](#)
 Front passenger airbag, indicator light [187](#)
 Front radar sensor, see Sensors in the vehicle [42](#)
 Front seats [106](#)
 Fuel [374](#)
 Fuel filler cap [346](#)
 Fuel filler flap [346](#)
 Fuel grade [374](#)
 Fuel level indicator [166](#)
 Fuel recommendation [374](#)
 Fuel tank, see Capacities [413](#)
 Fuel tank volume [413](#)
 Fuses [393](#)

G

Garage door opener, see Integrated universal remote control [306](#)
 Gear change, Steptronic transmission [136](#)
 General driving notes [325](#)
 Gesture control [65](#)
 Gestures, see BMW gesture control [65](#)
 Glare protection, see Sun visor [308](#)
 Glove compartment [315](#)
 G-Meter [165](#)
 GPS navigation, navigation, see Owner's Handbook for Navigation, Entertainment, Communication [6](#)
 Guest profile, see BMW ID [75](#)

H

Handbrake, see Parking brake [144](#)
 Hand-held transmitter, alternating-code [307](#)
 Hands-free system, see Owner's Handbook for Navigation, Entertainment, Communication [6](#)
 Hazard warning lights [394](#)
 Head airbag [184](#)
 Headlight flasher [170](#)
 Headlight glass [390](#)
 Headlights, adaptive [176](#)
 Headlights, care [405](#)
 Headlights, setting, see Right-hand/left-hand traffic [177](#)
 Headliner [41](#)
 Head restraints and seats [106](#)
 Head restraints, front [113](#)
 Head restraints, rear [115](#)
 Head-up display [150](#)
 Head-up display, care [407](#)
 Head-up Display position, saving, see Memory function [119](#)
 Heating, see Pre-cooling [301](#)
 Heavy load, stowing [318](#)
 Height, vehicle [410](#)
 Help in case of a breakdown [394](#)
 High-beam Assistant [171](#)
 High-beam headlight [170](#)
 Holder for drinks, front [316](#)

Holder for drinks, rear [317](#)
 Holder, pennant [328](#)
 Home lights [175](#)
 Home lights, switching on [175](#)
 HomeLink, see Integrated universal remote control [306](#)
 Home page, see Internet [7](#)
 Horn [38](#)
 Hotel function, see Valet parking mode [98](#)
 Hot exhaust system [325](#)
 Hotline, see Customer support [394](#)
 Hour, see Time [165](#)

I

iBrake – PostCrash [220](#)
 Ice warning, see Outside temperature [162](#)
 IconicSounds [290](#)
 Icons and displays [7](#)
 Icy roads, see Outside temperature [162](#)
 Identification number, see Vehicle identification number [20](#)
 iDrive [51](#)
 Ignition key, see Vehicle key [80](#)
 Important considerations [122](#)
 Inclination, backrest [108](#)
 Indicator light, front passenger airbag [187](#)
 Indicator lights [152](#)
 Individual air distribution [295](#)
 Individual settings, see BMW ID [75](#)
 Inductive charging, smartphone, see Wireless charging tray [310](#)
 Initialisation, see Flat Tyre Monitor [365](#)
 Input comparison [53](#)
 Installing child restraint systems [123](#)
 Instrument cluster [148](#)
 Instrument lighting [178](#)
 Instrument panel, see Instrument cluster [148](#)
 Integral Active Steering [226](#)
 Integrated key [82](#)
 Integrated Owner's Handbook in the vehicle [6](#)
 Integrated universal remote control [306](#)
 Intelligent emergency call [397](#)
 Intelligent Personal Assistant [60](#)
 Intended use [9](#)
 Interior camera [312](#)

Interior equipment [306](#)
 Interior filter [301](#)
 Interior lights [178](#)
 Interior lights, locked vehicle [174](#)
 Interior mirror [118](#)
 Interior movement detector [101](#)
 Intersection Assistant, see Traffic light detection [258](#)
 Interval display, see Service notification [168](#)
 i-Size child restraint systems [125](#)
 ISOFIX, child safety seat fasteners [125](#)

J

Jacking points [368](#)
 Journey data [163](#)
 Joystick, Steptronic transmission [136](#)
 Jump start [399](#)
 Jump starting, see Jump start [399](#)
 Jump start terminals [400](#)

K

Kenaf, care [407](#)
 Key Card [92](#)
 Keyless Go, see Comfort Access [87](#)
 Key, mechanical [82](#)
 Key, see Vehicle key [80](#)
 Kickdown, Steptronic transmission [136](#)

L

Laminated vehicle glass [326](#)
 Lane boundary, warning [200](#)
 Lane Change Assistant [248](#)
 Lane Change Warning [204](#)
 Lane change with active route guidance [256](#)
 Lane Departure Warning [200](#)
 Lane Keeping Assistant with active side collision protection, see Side collision warning [207](#)
 Language, setting [62](#)
 Lashing eyes in the luggage compartment [319](#)
 Lashing straps, see Lashing eyes in the luggage compartment [319](#)
 Last service, see Service history [168](#)

Lateral Parking Aid [266](#)
 Launch Control [139](#)
 Laying up the vehicle [408](#)
 Leather care [406](#)
 LED headlights, replacing, see Lights and bulbs [390](#)
 Left-hand traffic, light setting [177](#)
 Legal emergency call [396](#)
 Length, vehicle [410](#)
 Light-alloy wheels, care [407](#)
 Light in exterior mirror, see Crossing-traffic Warning [214](#)
 Lighting [172](#)
 Lighting, loudspeakers [180](#)
 Light in the exterior mirror, see Lane Change Warning [204](#)
 Lights [170](#)
 Lights and bulbs [390](#)
 Lights, care [405](#)
 Light switch [172](#)
 List, instrument cluster, see Selection lists [159](#)
 Live Cockpit Plus, see BMW Curved Display [55](#)
 Live Cockpit Professional, see BMW Curved Display [55](#)
 Live Vehicle [149](#)
 Load [318](#)
 Loading [318](#)
 Loading the luggage compartment, see Load [318](#)
 Local time, see Time [165](#)
 Locking, doors and windows [132](#)
 Locking, see Opening and closing [80](#)
 Locking, settings [98](#)
 Locking the automatic rear air conditioning system [293](#)
 Locking wheel bolts [368](#)
 Lock, wheel bolts [368](#)
 Lock, window lifters, see Safety switch [104](#)
 Long stationary periods, see Deep sleep mode [48](#)
 Loudspeaker lighting [180](#)
 Low-beam headlight [174](#)
 Lower back support, see Lumbar support [109](#)
 Luggage compartment [318](#)
 Luggage compartment emergency release [92](#)
 Luggage compartment, extending [320](#)

Luggage compartment, locking, see Valet parking mode [98](#)
 Luggage compartment with emergency spare wheel, extending [319](#)
 Luggage rack, see Roof bars [328](#)
 Lumbar support [109](#)

M

Maintenance requirement, see Condition Based Service [386](#)
 Maintenance System, BMW [386](#)
 Main user, see BMW ID [76](#)
 Make-up mirror [308](#)
 Malfunction displays, see Check Control [151](#)
 Malfunction, vehicle key [84](#)
 Manoeuvre Assistant [283](#)
 Manually unlock doors, see Integrated key [82](#)
 Manual mode, transmission [138](#)
 Map, see Owner's Handbook for Navigation, Entertainment, Communication [6](#)
 Map update, see Owner's Handbook for Navigation, Entertainment, Communication [6](#)
 Matt paintwork, care [406](#)
 Maximum cooling [296](#)
 Maximum speed, display, see Speed Limit Info [227](#)
 Maximum speed, winter tyres [352](#)
 Medical supplies, see First-aid kit [394](#)
 Memory function [119](#)
 Messages, see Check Control [151](#)
 Messages, see Owner's Handbook for Navigation, Entertainment, Communication [6](#)
 Meters, see Instrument cluster [148](#)
 Methyl ester, see Diesel [375](#)
 Microfilter, see Interior filter [301](#)
 Mild hybrid technology [392](#)
 Minimum tread depth, tyres [350](#)
 Minute, see Time [165](#)
 Mirror position, saving, see Memory function [119](#)
 Mirror, vanity [308](#)
 Mobile communications in the vehicle [326](#)
 Mobile phone, see Owner's Handbook for Navigation, Entertainment, Communication [6](#)
 Mobility system, see Tyre repair kit [353](#)

- MODE button, see Cruise Control Systems [231](#)
- Moisture in the headlights, see Headlight glass [390](#)
- Monitoring tyre pressure, see Flat tyre monitor [364](#)
- Monitoring tyre pressure, see Tyre Pressure Monitor [358](#)
- Monitor, see Control display [55](#)
- Motorway assistant, Assisted Driving Mode Plus, see Cruise Control Systems [231](#)
- MP3 player, see Owner's Handbook for Navigation, Entertainment, Communication [6](#)
- Multifunction hook [319](#)
- Multifunction steering wheel, buttons [38](#)
- Music track, gesture control [66](#)
- My BMW app, see Owner's Handbook for Navigation, Entertainment, Communication [6](#)
- My Modes [141](#)
- ## N
- Neck restraints, front, see Front head restraints [113](#)
- Neck restraints, rear, see Rear head restraints [115](#)
- Neutral cleaner, see Light-alloy wheels, care [407](#)
- No-overtaking indicator [227](#)
- No Passing information, see Speed Limit Display with no-overtaking indicator [227](#)
- Notes [6](#)
- Notifications, see Owner's Handbook for Navigation, Entertainment, Communication [6](#)
- Nylon rope for tow-starting/towing away [402](#)
- ## O
- OBD, see On-board diagnosis [387](#)
- Obstacle marking, additional displays camera views [263](#)
- Octane number, see Petrol grade [375](#)
- Odometer, see Trip data [163](#)
- OFF display, instrument cluster, see Standby state and Drive-ready state [161](#)
- Oil filler neck [381](#)
- Oil grades for topping up, engine [381](#)
- Oil level, checking electronically [380](#)
- Oil service interval, see Service notification [168](#)
- Oil, topping up [381](#)
- On-board computer, see Trip data [163](#)
- On-board diagnosis [387](#)
- On-board monitor, see Control display [55](#)
- One-touch signalling [170](#)
- Open circuit [392](#)
- Opening and closing [80](#)
- Opening and closing the boot lid [88](#)
- Opening and closing the luggage compartment [88](#)
- Opening with a smartphone, see BMW Digital Key [94](#)
- Opening with the Key Card [92](#)
- Operating condition of the vehicle [47](#)
- Operating menus, see BMW iDrive [51](#)
- Operating principle, see BMW iDrive [51](#)
- Operating System, see BMW iDrive [51](#)
- Operating temperature, see Engine temperature [161](#)
- Operating the boot lid contactlessly [91](#)
- Operation by voice control [60](#)
- Optimum shift indicator [160](#)
- Optional equipment, see Vehicle equipment [8](#)
- Outlets, see Ventilation [300](#)
- Outside temperature [162](#)
- Overheating of the engine, see Engine temperature [161](#)
- Owner's Handbook on language, BMW Intelligent Personal Assistant [62](#)
- Own safety [9](#)
- ## P
- Paintwork, vehicle care [405](#)
- Panorama View [269](#)
- Panorama View, see Panorama View [269](#)
- Panoramic display, see Owner's Manual for Navigation, Entertainment, Communication [6](#)
- Park Assist [277](#)
- Park Assist Professional [277](#)
- Park Assist, see Manoeuvre Assistant [283](#)
- Park Distance Control [272](#)
- Parking aid, see Park Distance Control [272](#)

Parking assistance lines, additional camera views [263](#)

Parking assistance systems [260](#)

Parking Assistant [277](#)

Parking Assistant Plus, see Parking assistance systems [260](#)

Parking Assistant Professional, see Parking assistance systems [260](#)

Parking Assistant, see Parking assistance systems [260](#)

Parking brake [144](#)

Parking brake function, see Active Park Distance Control [275](#)

Parking light [174](#)

Parking view, gesture control [66](#)

Parking with Automatic Hold [146](#)

Particle filter, see Exhaust gas particulate filter [325](#)

Particulate filter, see Interior filter [301](#)

Part replacement [389](#)

Parts and accessories [10](#)

Payload, technical data [411](#)

PDC, see Park Distance Control [272](#)

Pedestrian protection, acoustic [133](#)

Pedestrian protection, active [187](#)

Pedestrian Warning, see Front collision warning [190](#)

Pennant holder [328](#)

Personal Assistant [60](#)

Personal data, deleting [74](#)

Personal eSIM, see Owner's Manual for Navigation, Entertainment, Communication [6](#)

Personal hotspot, see Owner's Handbook for Navigation, Entertainment, Communication [6](#)

Personal Mode, see My Modes [141](#)

Personal profile, see BMW ID [75](#)

Personal settings [74](#)

Petrol [374](#)

Petrol grade [375](#)

Petrol particulate filter, see Exhaust gas particulate filter [325](#)

Phone call, gesture control [66](#)

Physical units, see Setting units of measurement [166](#)

Place for children [122](#)

Plasters, see First-aid kit [394](#)

Plastic parts, care [407](#)

Pop-ups, control display [54](#)

Possible gestures, gesture control [66](#)

PostCrash – iBrake [220](#)

Power display, instrument cluster [160](#)

Power display, see Sport displays [168](#)

Powermeter, see Power display [160](#)

Power window regulators [102](#)

Pre-conditioning via Remote Engine Start [303](#)

Pre-cooling/pre-heating [301](#)

Pressure, tyres [348](#)

Pressure warning, see Flat tyre monitor [364](#)

Pressure warning, see Tyre Pressure Monitor [358](#)

Protective function, windows, see Anti-trap mechanism [103](#)

R

Racing track [329](#)

Radar sensors, see Sensors in the vehicle [42](#)

Radiator fan, see Exhaust gas particulate filter [325](#)

Radio information, see Owner's Manual for Navigation, Entertainment, Communication [6](#)

Radio, see Owner's Handbook for Navigation, Entertainment, Communication [6](#)

Radio signals [326](#)

Radio stations, see Owner's Manual for Navigation, Entertainment, Communication [6](#)

Rain sensor [181](#)

Range [166](#)

Rapeseed methyl ester RME, see Diesel [375](#)

READY display, instrument cluster, see Standby state and Drive-ready state [161](#)

Real Time Traffic Information, see Owner's Handbook for Navigation, Entertainment, Communication [6](#)

Rear carrier [338](#)

Rear Collision Prevention, see Rear collision warning [209](#)

Rear collision warning [209](#)

Rear fog light [177](#)

Rear fog light, replacing, see Lights and bulbs [390](#)

Rear light, replacing, see Lights and bulbs [390](#)

- Rear-mounted luggage rack, see Rear carrier [338](#)
- Rear seat backrests, folding down [320](#)
- Rear-view mirror with automatic anti-dazzle function [118](#)
- Rear-wheel steering, see Integral Active Steering [226](#)
- Rear window heating [298](#)
- Recirculation, see Air recirculation function [297](#)
- Recommended gear for fuel-efficient driving, see Optimum shift indicator [160](#)
- Recommended tyre makes [352](#)
- Recuperation, adaptive [340](#)
- Recycling, see Recycling [388](#)
- Reduced drive power [160](#)
- Reducing agent, see BMW diesel with Blue-Performance [376](#)
- Refuelling [346](#)
- Releasing the fuel filler flap, manual [347](#)
- Releasing the transmission lock, electronic [138](#)
- Remote 3D View [271](#)
- Remote Control Parking [286](#)
- Remote control, see Vehicle key [80](#)
- Remote control, universal [306](#)
- Remote Engine Start, see Pre-conditioning [303](#)
- Remote operation, see Remote Control Parking [286](#)
- Remote services, see Owner's Handbook for Navigation, Entertainment, Communication [6](#)
- Remote Software Upgrade [70](#)
- Renewal, wheels and tyres [351](#)
- Replacement of parts [389](#)
- Replacement, wheels and tyres [351](#)
- Replacing bulbs, see Lights and bulbs [390](#)
- Replacing front lights, see Lights and bulbs [390](#)
- Replacing headlights, see Lights and bulbs [390](#)
- Replacing light-emitting diodes, see Lights and bulbs [390](#)
- Replacing lights, see Lights and bulbs [390](#)
- Replacing parts [389](#)
- Replacing rear lights, see Lights and bulbs [390](#)
- Reserve warning, see Range [166](#)
- Resetting, vehicle data [75](#)
- Reset, Tyre Pressure Monitor [361](#)
- Reset, vehicle settings [75](#)
- Restraint systems for children, see Carrying children safely [122](#)
- Restricted Driving, see BMW Digital Key [94](#)
- Rest state, see Operating condition of the vehicle [47](#)
- Retreaded tyres [352](#)
- Reversing Assistant [287](#)
- Reversing Assistant Professional [287](#)
- Reversing Assist Camera [265](#)
- Reversing camera, see Sensors in the vehicle [42](#)
- Revolution counter [161](#)
- Right-hand traffic, light setting [177](#)
- Risk of collision when exiting [199](#)
- RME rapeseed methyl ester, see Diesel [375](#)
- Road Priority Warning [209](#)
- Roadside Assistance, see BMW Accident Assistance [396](#)
- Roadside Assistance, see BMW Roadside Assistance [395](#)
- Roller sunblinds, rear side windows [104](#)
- Rolling in idle, see Coasting [341](#)
- RON, see Petrol grade [375](#)
- Roof bars [328](#)
- Roof load, permitted [411](#)
- Roof luggage bars, see Roof bars [328](#)
- Rope for tow-starting/towing away [402](#)
- Roundabout light [177](#)
- Route and Intersection Assistant, see Adjusting speed to route [255](#)
- Route and Intersection Assistant, see Traffic light detection [258](#)
- Route, navigation, see Owner's Handbook for Navigation, Entertainment, Communication [6](#)
- Rubber parts, care [407](#)
- Running in [324](#)
- Running-in instructions [324](#)

S

- Safe Exit, see Exit warning [199](#)
- Safe seating position [106](#)
- Safe Share function, see BMW Digital Key [94](#)

- Safety and warning, refer to Collision warning systems [188](#)
- Safety package, see Active Protection [219](#)
- Safety switch, windows [104](#)
- Safety systems, refer to Collision warning systems [188](#)
- Safety systems, see Airbags [184](#)
- Saved stations, see Owner's Manual for Navigation, Entertainment, Communication [6](#)
- Saving energy, see Optimum shift indicator [160](#)
- Sealing compound, see Tyre repair kit [353](#)
- Seamless mode change, see Remote Control Parking [286](#)
- Seat belt reminder, see Seat belt warning [112](#)
- Seat belts [110](#)
- Seat belts, care [408](#)
- Seat belt warning [112](#)
- seat calibration [109](#)
- Seat heating [298](#)
- Seat position, saving, see Memory function [119](#)
- Seats and head restraints [106](#)
- Seats, front [106](#)
- Seat ventilation, active [299](#)
- Securing, load [318](#)
- Selection list in the instrument cluster [159](#)
- Selector lever, Steptronic transmission [136](#)
- Semi-automatic camera perspective [266](#)
- Sensors, care [408](#)
- Sensors in the vehicle [42](#)
- Service [386](#)
- Service history [168](#)
- Service notification [168](#)
- Service requirement, see Condition Based Service [386](#)
- Service, see BMW Accident Assistance [396](#)
- Service, see BMW Roadside Assistance [395](#)
- Service, see Service notification [168](#)
- SET button, see Cruise Control Systems [231](#)
- Setting the time [165](#)
- Shift Lights, revolution counter [162](#)
- Shift paddles on the steering wheel [138](#)
- Shortcuts, iDrive [54](#)
- Side airbag [184](#)
- Side collision warning [207](#)
- Side lights [173](#)
- Side nozzles, see Ventilation [300](#)
- Side protection, see Automatic camera perspective [266](#)
- Signal horn, horn [38](#)
- Signals when unlocking, see Confirmation signals [99](#)
- SIM Reader, see Owner's Handbook for Navigation, Entertainment, Communication [6](#)
- Sizes, see Dimensions [410](#)
- Smallest turning radius, vehicle [410](#)
- Smartphone, operating via voice input [64](#)
- Smartphone, see Owner's Handbook for Navigation, Entertainment, Communication [6](#)
- Snaking movement of the trailer, see Trailer Stability Control [337](#)
- Snapshot camera, see Interior camera [312](#)
- Snow chains [357](#)
- Socket for on-board diagnosis [387](#)
- Sockets, electrical devices [308](#)
- Soft-close function for doors, doors [97](#)
- Software update, see Remote Software Upgrade [70](#)
- Software upgrade, see Remote Software Upgrade [70](#)
- Software version, see Remote Software Upgrade [70](#)
- Soot particulate filter, see Exhaust gas particulate filter [325](#)
- SOS button, see Intelligent emergency call [397](#)
- SOS button, see Legal emergency call [396](#)
- Sound of the engine, see BMW Iconic Sounds [290](#)
- Sound settings, see Owner's Handbook for Navigation, Entertainment, Communication [6](#)
- Sound system, see Owner's Manual for Navigation, Entertainment, Communication [6](#)
- Spare wheel, see Emergency spare wheel [370](#)
- Speech recognition [60](#)
- Speed Limit Assist [253](#)
- Speed Limit Device, speed limiter, see Cruise Control Systems [231](#)
- Speed limit, display, see Speed Limit Info [227](#)
- Speed limiter, manual, see Cruise Control Systems [231](#)
- Speed Limit Info [227](#)
- Speed Limit Info with anticipation [229](#)

- Speed limit warning [227](#)
Sport Boost function [140](#)
Sport displays [168](#)
Sport Mode, see My Modes [141](#)
SPORT PLUS setting, see Setting for increased driving dynamics [224](#)
Sport programme, transmission [136](#)
Stability control systems [223](#)
Standard equipment, see Vehicle equipment [8](#)
Standby state, see Operating condition of the vehicle [47](#)
Start/Stop button [133](#)
Starting, see Drive-ready state [49](#)
Starting the engine, see Drive-ready state [49](#)
Starting the engine with the Key Card [92](#)
Stations, see Owner's Manual for Navigation, Entertainment, Communication [6](#)
Status indicator, tyres [360](#)
Status information, iDrive [52](#)
Status of the Owner's Handbook [8](#)
Status, vehicle [167](#)
Steering column adjustment [119](#)
Steering, see Integral Active Steering [226](#)
Steering wheel, adjusting [119](#)
Steering wheel, buttons [38](#)
Steering wheel heating [299](#)
Steering wheel position, saving, see Memory function [119](#)
Steptronic sport transmission, see Steptronic transmission [136](#)
Steptronic transmission [136](#)
Stopping the engine, see Drive-ready state [49](#)
Storage compartment, centre console [316](#)
Storage compartment, luggage compartment [319](#)
Storage compartments [315](#)
Storage, see Laying up the vehicle [408](#)
Storage, tyres [353](#)
Stowing, load [318](#)
Summer tyres, tread [350](#)
Sun visor [308](#)
Supplementary Owner's Handbook [7](#)
Suspension, see Adaptive suspension Professional [290](#)
Switches, see Vehicle cockpit [38](#)
SYNC programme, automatic air conditioning [297](#)
System, alarm, see Alarm system [100](#)
System language, setting, see Language [62](#)
- ## T
- Tank display [166](#)
Technical changes, see Own safety [9](#)
Technical data [410](#)
Telephone, see Owner's Handbook for Navigation, Entertainment, Communication [6](#)
Telephone, selection list in the instrument cluster [159](#)
Teleservices, see Owner's Handbook for Navigation, Entertainment, Communication [6](#)
Temperature, automatic air conditioning [294](#)
Temperature display, see Outside temperature [162](#)
Tensioning strap, see Lashing eyes in the luggage compartment [319](#)
Terminal, jump start [400](#)
Thigh support [109](#)
Tilt alarm sensor [101](#)
Tilting down, front passenger's mirror, see Automatic parking function [118](#)
Time [165](#)
Time of day, see Time [165](#)
Time setting, automatic [165](#)
Time zone [165](#)
Toolkit [389](#)
Tools [389](#)
Torque display, see Sport displays [168](#)
Total weight, permitted [411](#)
Total weight, trailer operation [412](#)
Touchpad, Controller [58](#)
Tourist function, see Right-hand/left-hand traffic [177](#)
Towbar [402](#)
Tow fitting, see Towing eye [402](#)
Towing away [401](#)
Towing eye [402](#)
Towing rope [402](#)
Towing, see Tow-starting and towing away [401](#)
Tow-starting [401](#)

Tracking, Assisted Driving Mode, see Cruise Control Systems [231](#)

Traction control system, see Dynamic Stability Control [223](#)

Traffic information, see Owner's Handbook for Navigation, Entertainment, Communication [6](#)

Traffic information, see Owner's Manual for Navigation, Entertainment, Communication [6](#)

Traffic jam assistant, Assisted Driving Mode Plus, see Cruise Control Systems [231](#)

Traffic light detection [258](#)

Traffic-queue assistant, Assisted Driving Mode Plus, see Cruise Control Systems [231](#)

Trailer Assistant [335](#)

Trailer loads [412](#)

Trailer nose weight, technical data [412](#)

Trailer operation [330](#)

Trailer operation, activation [334](#)

Trailer operation, technical data [412](#)

Trailer Stability Control [337](#)

Trailer tow hitch, ball head, electrically adjustable [331](#)

Trailer tow hitch view [268](#)

Transmission, see Steptronic transmission [136](#)

Travel & Comfort System [309](#)

Tread, tyres [350](#)

Trip data [163](#)

Trip odometer, see Trip data [163](#)

Turn indicator [170](#)

Turn indicator, indicator light [156](#)

Turn indicator, replacing bulbs, see Lights and bulbs [390](#)

Turning circle lines, additional displays camera views [263](#)

Turning radius, vehicle [410](#)

Turning up, dimming, see High-beam Assistant [171](#)

Turn Warning, see Front collision warning [190](#)

Tyre age [351](#)

Tyre change [351](#)

Tyre damages [350](#)

Tyre inflation pressure [348](#)

Tyre makes, recommended [352](#)

Tyre pressure [348](#)

Tyre Pressure Monitor [358](#)

Tyre Pressure Monitor, reset [361](#)

Tyre pressure warning, see Flat tyre monitor [364](#)

Tyre pressure warning, see Tyre Pressure Monitor [358](#)

Tyre repair kit [353](#)

Tyres and wheels [348](#)

Tyre sealant, see Tyre repair kit [353](#)

Tyre settings [359](#)

Tyre tread [350](#)

U

UCC, see Traffic light detection [258](#)

Ultrasonic sensors, see Sensors in the vehicle [42](#)

Units of measurement, setting [166](#)

Units, see Setting units of measurement [166](#)

Universal remote control [306](#)

Unloaded weight [411](#)

Unlocking, see Opening and closing [80](#)

Unlocking, settings [98](#)

Updates after going to press [8](#)

Upgrade, see Remote Software Upgrade [70](#)

Upper retaining strap, top tether [126](#)

Urban Cruise Control, see Traffic light detection [258](#)

USB audio, see Owner's Handbook for Navigation, Entertainment, Communication. [6](#)

USB port, position in the vehicle [309](#)

Use, intended [9](#)

User, see BMW ID [75](#)

V

Valet parking mode [98](#)

Vanity mirror [308](#)

Variable light distribution [176](#)

Variable steering, see Integral Active Steering [226](#)

Vehicle battery [390](#)

Vehicle breakdown, see Help in case of a breakdown [394](#)

Vehicle care [405](#)

Vehicle cockpit [38](#)

Vehicle data and data protection [10](#)

Vehicle data, resetting [75](#)

- Vehicle equipment [8](#)
 - Vehicle identification number [20](#)
 - Vehicle key [80](#)
 - Vehicle key, additional [80](#)
 - Vehicle key, loss [81](#)
 - Vehicle, laying up [408](#)
 - Vehicle paintwork, care [405](#)
 - Vehicle status [167](#)
 - Vehicle wash [404](#)
 - Ventilation [300](#)
 - Ventilation, see Pre-cooling [301](#)
 - Video recording, see BMW Drive Recorder [216](#)
 - Video, see Owner's Handbook for Navigation, Entertainment, Communication [6](#)
 - VIN, see Vehicle identification number [20](#)
 - Voice control [60](#)
 - Voice control system [60](#)
 - Voice input, see BMW Intelligent Personal Assistant [60](#)
 - Volume, gesture control [66](#)
 - Volume, see Owner's Handbook for Navigation, Entertainment, Communication [6](#)
- W**
- Warning function for oncoming traffic, see Front collision warning [190](#)
 - Warning function, rear collision [209](#)
 - Warning function with wrong direction of travel, see Wrong-way Warning [212](#)
 - Warning in case of crossing traffic [214](#)
 - Warning light in exterior mirror, see Crossing-traffic Warning [214](#)
 - Warning light in the exterior mirror, see Lane Change Warning [204](#)
 - Warning lights [152](#)
 - Warning messages, see Check Control [151](#)
 - Warning systems for collision risk [188](#)
 - Warning triangle [394](#)
 - Warning when exiting [199](#)
 - Warning when opening the doors, see Exit warning [199](#)
 - Warranty [9](#)
 - Warranty Booklet, see Warranty [9](#)
 - Washer fluid [384](#)
 - Washer fluid, reservoir [384](#)
 - Washing fluid, see Washer fluid [384](#)
 - Wash, vehicle [404](#)
 - Water on roads [326](#)
 - Water, see Condensation when vehicle is parked [328](#)
 - Web page, see Internet [7](#)
 - Website [7](#)
 - Weights [411](#)
 - Welcome display, driver profiles [75](#)
 - Welcome light [174](#)
 - Wheelbase, vehicle [410](#)
 - Wheel change [366](#)
 - Wheels and tyres [348](#)
 - Wheels and tyres, exchange [351](#)
 - Widgets, iDrive [52](#)
 - Widgets, instrument cluster, see Central indication range [162](#)
 - Width, vehicle [410](#)
 - Wi-Fi connection, see Owner's Handbook for Navigation, Entertainment, Communication [6](#)
 - Window, defrosting [298](#)
 - Window lifters [102](#)
 - Window mist [298](#)
 - Windscreen, climate comfort [326](#)
 - Windscreen, defrosting [298](#)
 - Windscreen, removing condensation [298](#)
 - Windscreen washing system, see Wiper system [180](#)
 - Windscreen wiper, fold-out position [182](#)
 - Windscreen wipers [180](#)
 - Windscreen wipers, see Wiper system [180](#)
 - Windshield, removing condensation [298](#)
 - Winter storage, see Laying up the vehicle [408](#)
 - Winter tyres [353](#)
 - Winter tyres, tread [350](#)
 - Wiper blades, changing [389](#)
 - Wipers, see Wiper system [180](#)
 - Wiping fluid, see Washer fluid [384](#)
 - Wireless charging, smartphone, see Wireless charging tray [310](#)
 - Wireless charging tray for smartphones [310](#)
 - Wood parts, care [407](#)
 - Wordmatch principle, see Input comparison [53](#)
 - Workshop, see Service notification [168](#)
 - Wrong-way Warning [212](#)

X

xDrive [225](#)



01405A8A572 en

BMW DRIVER'S GUIDE APP.

YOUR DIGITAL VEHICLE INFORMATION.

The BMW Driver's Guide app tells you all about your vehicle's equipment and offers additional content and functions:

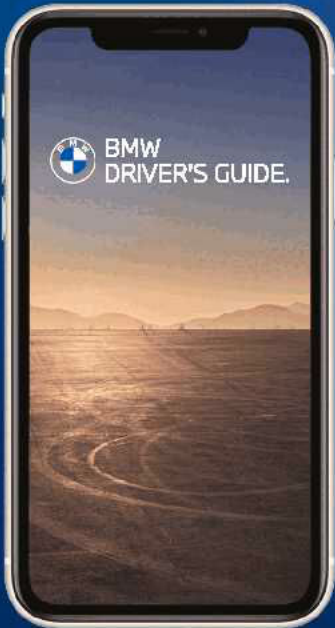

Everything you need to know about navigation, entertainment and communication

Photo-realistic animated content demonstrating various vehicle functions

Keyword search

360° View: An interactive virtual tour of the interior and exterior of your vehicle

Smart Scan for Apple iPhone: Icon and optical character recognition on the buttons inside the vehicle

Available in more than 30 languages

Can be downloaded and used offline

